

RISH SURGICAL INSTRUMENTS

General Surgery | Instruments

CATALOGUE | NEW EDITION



RISH SURGICAL |



RISH SURGICAL
CARE OF TRUST

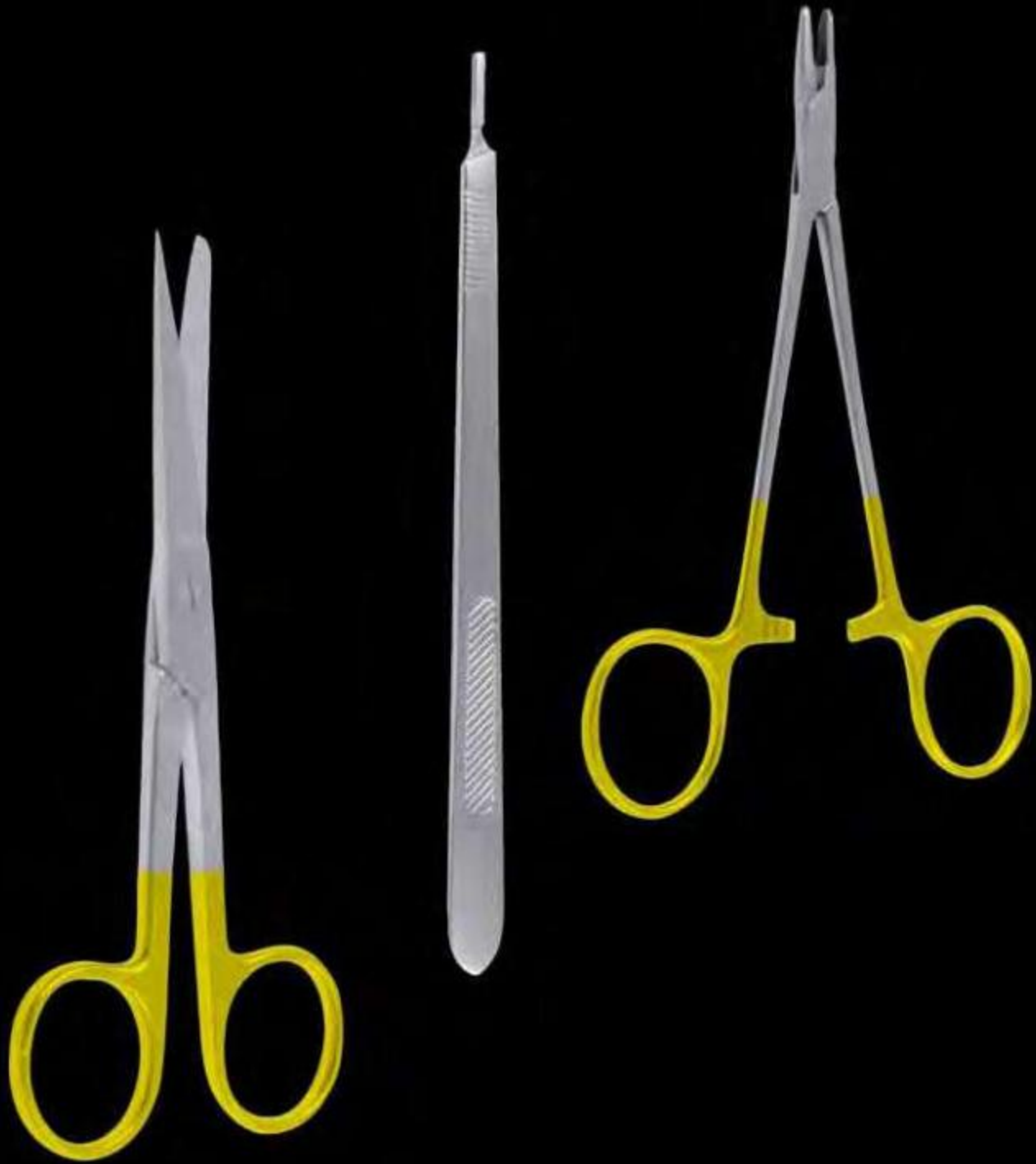



Skalpellklingen, Skalpellgriffe, Messer
Scalpel Blades, Scalpel Handles, Knives
Hojas de bisturías, Mangos de bisturías, Cuchillos
Lame per bisturi, Manici per bisturi, Coltelli

Sterile Skalpelling, Skalpellinggriffe
Sterile Scalpel Blades, Scalpel Handles
Hojas de bisturíes estériles, Mangos de bisturíes
Lame per bisturi sterili, Manici per bisturi



No. 3
13,0 cm, 5"
003-003-00



No. 3
13,0 cm, 5"
003-003-01



No. 3L
21,0 cm, 8¼"
003-003-02



No. 7
16,5 cm, 6½"
003-007-00



No. 7K
13,0 cm, 5"
003-007-01

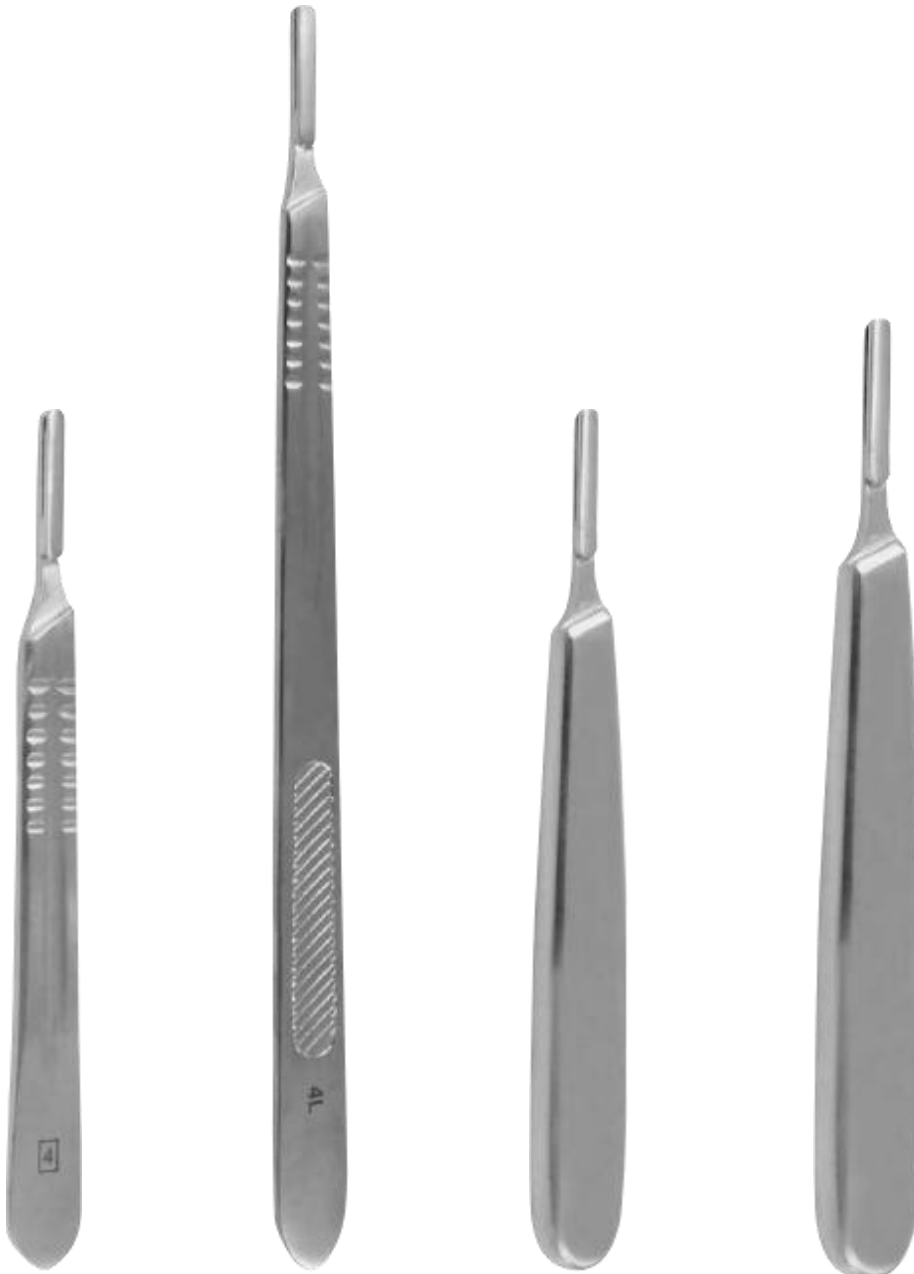

No. 4
13,5 cm, 5³/₈"
003-004-00

No. 4L
21,0 cm, 8³/₈"
003-004-01

No. 8
13,5 cm, 5³/₈"
003-008-00

No. 9
14,5 cm, 5³/₄"
003-009-00

Einmal-Skalpelle, steril
Disposable Scalpels, sterile
Bisturíes para uso único, estériles
Bisturi monouso, sterili



Fig. 10
003-050-10



Fig. 11
003-050-11



Fig. 11s
003-050-11S



Fig. 12
003-050-12



Fig. 12d
003-050-12D



Fig. 13
003-050-13



Fig. 15
003-050-15



Fig. 15c
003-050-15C



Fig. 18
003-050-18



Fig. 19
003-050-19



Fig. 20
003-050-20



Fig. 21
003-050-21



Fig. 22
003-050-22



Fig. 23
003-050-23



Fig. 24
003-050-24

Skalpelle
Knives
Bisturíes
Bisturi



Fig. 1 **003-066-01**
Fig. 2 **003-066-02**
Fig. 3 **003-066-03**



OPERATION
17,0 cm, 6¾"



Fig. 10 **003-060-10**
Fig. 12 **003-060-12**
Fig. 14 **003-060-14**
Fig. 16 **003-060-16**
Fig. 18 **003-060-18**



COLLIN
16,0 cm, 6¼"



Fig. 4 **003-066-04**
Fig. 5 **003-066-05**
Fig. 6 **003-066-06**



Fig. 1 **003-070-01**
Fig. 2 **003-070-02**
Fig. 3 **003-070-03**
Fig. 4 **003-070-04**
Fig. 5 **003-070-05**



Fig. 1 **003-076-01**
Fig. 2 **003-076-02**
Fig. 3 **003-076-03**
Fig. 4 **003-076-04**
Fig. 5 **003-076-05**



Fig. 15 **003-078-15**



DISSECTING
17,0 cm, 6¾"



Fig. 6 **003-070-06**
Fig. 7 **003-070-07**
Fig. 8 **003-070-08**
Fig. 9 **003-070-09**
Fig. 10 **003-070-10**



DIEFENBACH
16,0 cm, 6¼"

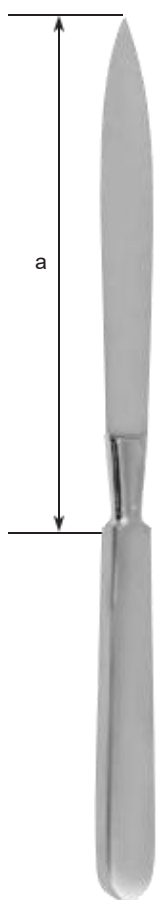

Fig. 6 **003-076-06**
Fig. 7 **003-076-07**
Fig. 8 **003-076-08**
Fig. 9 **003-076-09**



Fig. 16 **003-078-16**

Amputationsmesser
 Amputation Knives
 Cuchillos para amputación
 Coltelli per amputazione



COLLIN

a	
13,0 cm, 5"	003-080-13
16,0 cm, 6 ¹ / ₄ "	003-080-16
19,0 cm, 7 ¹ / ₂ "	003-080-19
22,0 cm, 8 ⁵ / ₈ "	003-080-22
28,0 cm, 11"	003-080-28

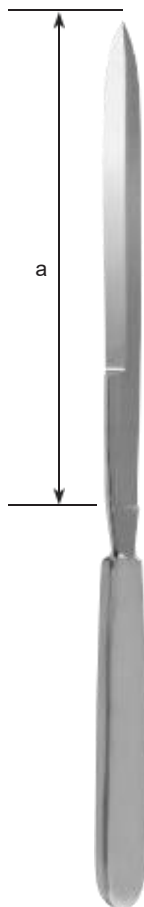

CATLIN

A	
16,0 cm, 6 ¹ / ₄ "	003-082-16
19,0 cm, 7 ¹ / ₂ "	003-082-19
22,0 cm, 8 ⁵ / ₈ "	003-082-22

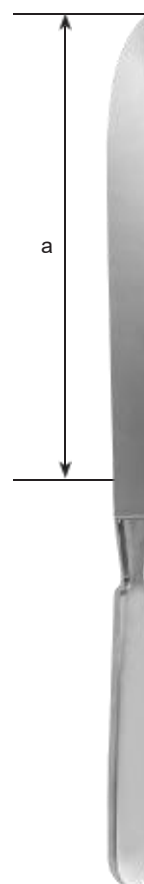

LISTON

A	
17,0 cm, 6 ³ / ₄ "	003-250-17
20,0 cm, 8"	003-250-20
22,0 cm, 8 ⁵ / ₈ "	003-250-22

Amputationsmesser, Messer für Autopsie
 Amputation Knives, Post Mortem Knives
 Cuchillos para amputación, Cuchillos para autopsia
 Coltelli per amputazione, Coltelli per autopsia

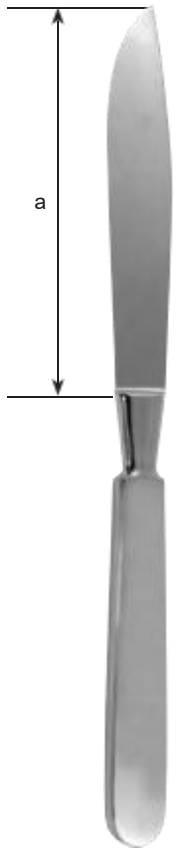

LANGENBECK
 003-280-12

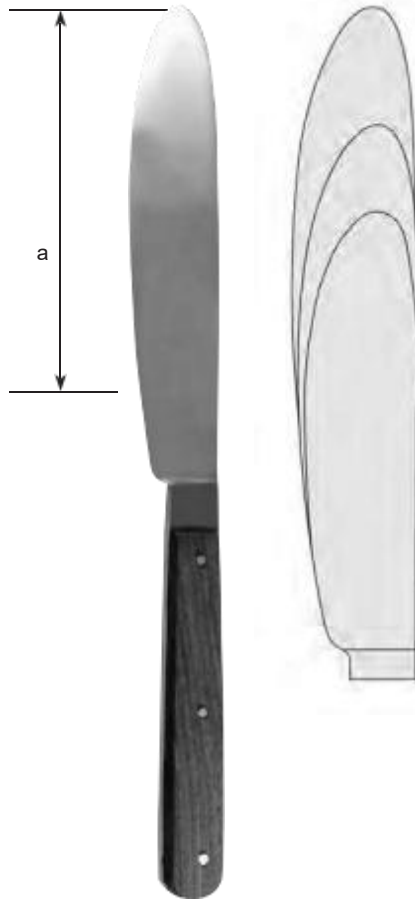

WALB

A	
11,0 cm, 4 1/2"	003-150-11
14,0 cm, 5 1/2"	003-150-14
17,0 cm, 6 3/4"	003-150-17

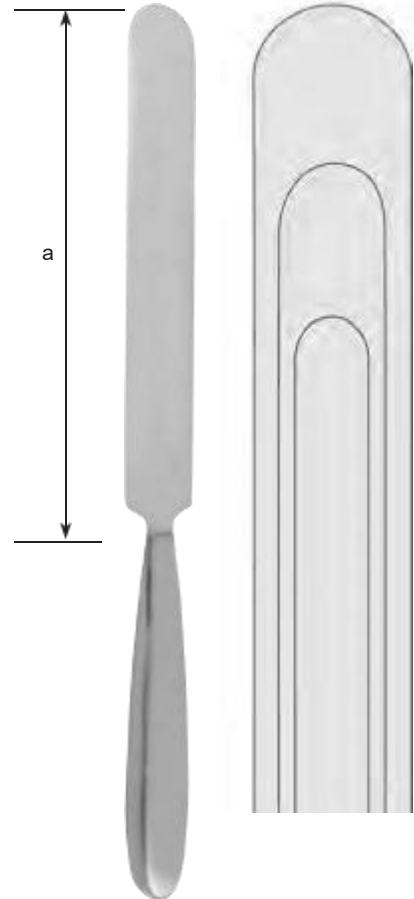

VIRCHOW

A	
16,0 cm, 6 1/4"	003-180-16
20,0 cm, 8"	003-180-20
24,0 cm, 9 1/2"	003-180-24

Amputationsmesser, Dermatome
Amputation Knives, Dermatomes
Cuchillos para amputación, Dermátomos
Coltelli per amputazione, Dermatomi



LANGENBECK
18,0 cm, 7"
003-105-55



CARTILAGE
17,5 cm, 6⁵/₈"
003-110-65

mit Schaber
with raspatory
con periostótomo
con raschiatoio

Haut-Spannplatten
Skin straightening plate
Placa para extender la piel
Placca per stenderela pelle



003-422-30

Resektionsmesser
Resection Knives
Cuchillos para resección
Coltelli per resezione

003-401-19
Ersatzklinge
Spare blade
Hoja de repuesto
Lama diricambio



SILVER
19 cm, 7 1/2"
003-400-19

003-411-30
Ersatzklinge
Spare blade
Hoja de repuesto
Lama diricambio



BRAITHWAITE
30,0 cm, 12"
003-410-30

003-413-35
Ersatzklinge
Spare blade
Hoja de repuesto
Lama diricambio



HUMBY
35,0 cm, 14"
003-412-35

003-421-30
Ersatzklinge
Spare blade
Hoja de repuesto
Lama diricambio



SCHINK
30,0 cm, 12"
003-420-30



Scheren

Scissors

Tijeras

Forbici



Made in Pakistan

Chirurgische Scheren
 Surgical Scissors
 Tijeras para cirugía
 Forbici per chirurgia



STANDARD	
10,5 cm, 4 ¹ / ₄ "	010-000-10
11,5 cm, 4 ¹ / ₂ "	010-000-11
13,0 cm, 5"	010-000-13
14,5 cm, 5 ³ / ₄ "	010-000-14
15,5 cm, 6"	010-000-15
16,5 cm, 6 ¹ / ₂ "	010-000-16
17,5 cm, 6 ⁵ / ₈ "	010-000-17
18,5 cm, 7 ¹ / ₄ "	010-000-18
20,0 cm, 8"	010-000-20



STANDARD	
10,5 cm, 4 ¹ / ₄ "	010-001-10
11,5 cm, 4 ¹ / ₂ "	010-001-11
13,0 cm, 5"	010-001-13
14,5 cm, 5 ³ / ₄ "	010-001-14
15,5 cm, 6"	010-001-15
16,5 cm, 6 ¹ / ₂ "	010-001-16
17,5 cm, 6 ⁵ / ₈ "	010-001-17
18,5 cm, 7 ¹ / ₄ "	010-001-18
20,0 cm, 8"	010-001-20

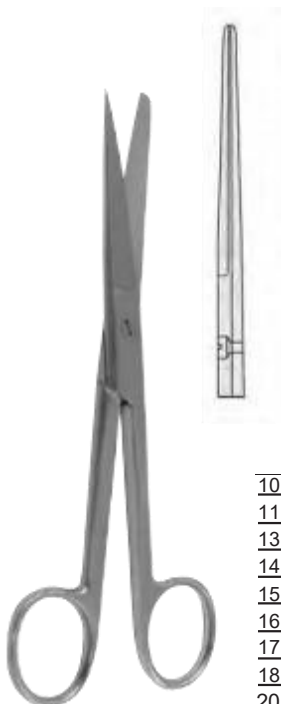

STANDARD	
10,5 cm, 4 ¹ / ₄ "	010-002-10
11,5 cm, 4 ¹ / ₂ "	010-002-11
13,0 cm, 5"	010-002-13
14,5 cm, 5 ³ / ₄ "	010-002-14
15,5 cm, 6"	010-002-15
16,5 cm, 6 ¹ / ₂ "	010-002-16
17,5 cm, 6 ⁵ / ₈ "	010-002-17
18,5 cm, 7 ¹ / ₄ "	010-002-18
20,0 cm, 8"	010-002-20



STANDARD	
10,5 cm, 4 ¹ / ₄ "	010-003-10
11,5 cm, 4 ¹ / ₂ "	010-003-11
13,0 cm, 5"	010-003-13
14,5 cm, 5 ³ / ₄ "	010-003-14
15,5 cm, 6"	010-003-15
16,5 cm, 6 ¹ / ₂ "	010-003-16
17,5 cm, 6 ⁵ / ₈ "	010-003-17
18,5 cm, 7 ¹ / ₄ "	010-003-18
20,0 cm, 8"	010-003-20



Made in Pakistan

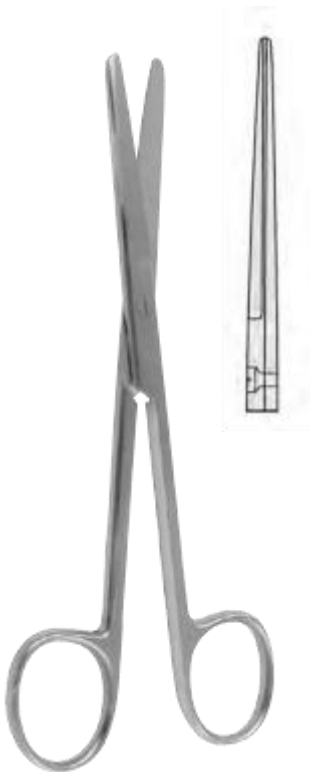
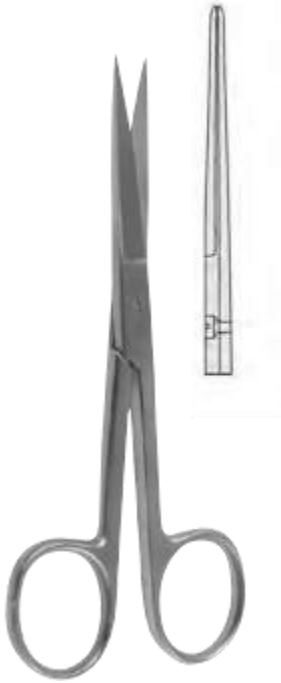

12,0 cm, 4³/₄" **010-050-12**
13,0 cm, 5" **010-050-13**
14,5 cm, 5³/₄" **010-050-14**



12,0 cm, 4³/₄" **010-051-12**
13,0 cm, 5" **010-051-13**
14,5 cm, 5³/₄" **010-051-14**



STANDARD

<u>10,5 cm, 4¹/₄"</u>	<u>010-004-10</u>
<u>11,5 cm, 4¹/₂"</u>	<u>010-004-11</u>
<u>13,0 cm, 5"</u>	<u>010-004-13</u>
<u>14,5 cm, 5³/₄"</u>	<u>010-004-14</u>
<u>15,5 cm, 6"</u>	<u>010-004-15</u>
<u>16,5 cm, 6¹/₂"</u>	<u>010-004-16</u>
<u>17,5 cm, 6³/₈"</u>	<u>010-004-17</u>
<u>18,5 cm, 7¹/₄"</u>	<u>010-004-18</u>
<u>20,0 cm, 8"</u>	<u>010-004-20</u>

STANDARD

<u>10,5 cm, 4¹/₄"</u>	<u>010-005-10</u>
<u>11,5 cm, 4¹/₂"</u>	<u>010-005-11</u>
<u>13,0 cm, 5"</u>	<u>010-005-13</u>
<u>14,5 cm, 5³/₄"</u>	<u>010-005-14</u>
<u>15,5 cm, 6"</u>	<u>010-005-15</u>
<u>16,5 cm, 6¹/₂"</u>	<u>010-005-16</u>
<u>17,5 cm, 6³/₈"</u>	<u>010-005-17</u>
<u>18,5 cm, 7¹/₄"</u>	<u>010-005-18</u>
<u>20,0 cm, 8"</u>	<u>010-005-20</u>

DEAVER

DEAVER



DEAVER

13.0 cm, 5" 010-052-13
12.6 cm, 5³/₄" 010-052-12



DEAVER

13.0 cm, 5" 010-053-13
12.6 cm, 5³/₄" 010-053-12



DEAVER

13.0 cm, 5" 010-054-13
12.6 cm, 5³/₄" 010-054-12



DEAVER

13.0 cm, 5" 010-055-13
12.6 cm, 5³/₄" 010-055-12

Präparierscheren
 Dissecting Scissors
 Tijeras de disección
 Forbici per dissezione



GRAZIL
 13,0 cm, 5" **010-070-13**
 14,5 cm, 5³/₄" **010-070-14**



GRAZIL
 13,0 cm, 5" **010-071-13**
 14,5 cm, 5³/₄" **010-071-14**



GRAZIL
 13,0 cm, 5" **010-072-13**
 14,5 cm, 5³/₄" **010-072-14**



GRAZIL
 13,0 cm, 5" **010-073-13**
 14,5 cm, 5³/₄" **010-073-14**

Präparierscheren
 Dissecting Scissors
 Tijeras de disección
 Forbici per dissezione



GRAZIL
 13,0 cm, 5" **010-074-13**
 14,5 cm, 5³/₄" **010-074-14**



GRAZIL
 13,0 cm, 5" **010-075-13**
 14,5 cm, 5³/₄" **010-075-14**

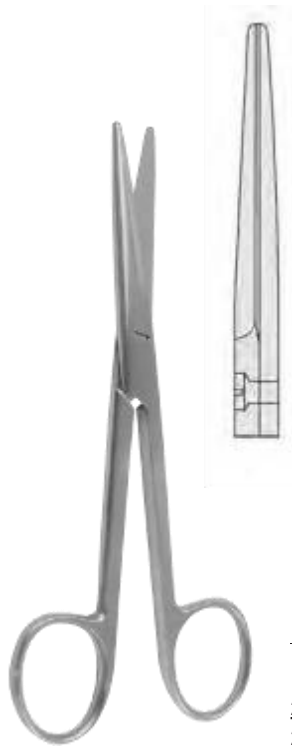

MAYO
 14,5 cm, 5³/₄" **010-100-14**
 17,0 cm, 6³/₄" **010-100-17**
 23,0 cm, 9" **010-100-23**
 28,0 cm, 11" **010-100-28**

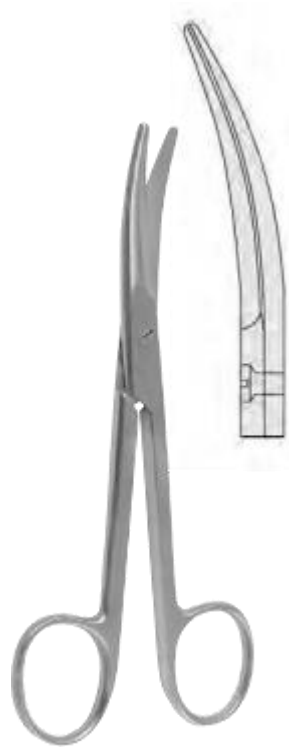

MAYO
 14,5 cm, 5³/₄" **010-101-14**
 17,0 cm, 6³/₄" **010-101-17**
 23,0 cm, 9" **010-101-23**
 28,0 cm, 11" **010-101-28**

MAYO-STILE

15,0 cm, 6"	010-102-15
17,0 cm, 6 ³ / ₄ "	010-102-17
19,5 cm, 7 ³ / ₄ "	010-102-19
21,0 cm, 8 ¹ / ₄ "	010-102-21

MAYO-STILE

15,0 cm, 6"	010-103-15
17,0 cm, 6 ³ / ₄ "	010-103-17
19,5 cm, 7 ³ / ₄ "	010-103-19
21,0 cm, 8 ¹ / ₄ "	010-103-21



010-104-17



010-105-17



MAYO-NOBLE

17,0 cm, 6³/₄"

FOMON

Präparierscheren
 Dissecting Scissors
 Tijeras de disección
 Forbici per dissezione



BABY-METZENBAUM
 11,5 cm, 4 1/2"

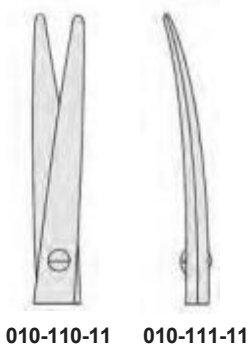

010-110-11 010-111-11



METZENBAUM
 14,5 cm, 5 3/4"

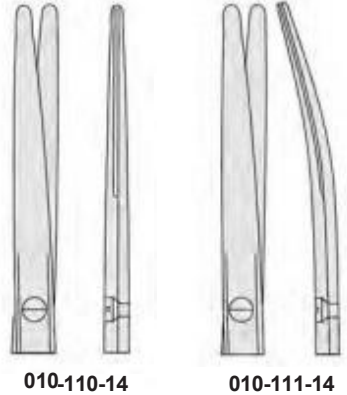

010-110-14 010-111-14



METZENBAUM
 14,5 cm, 5 3/4"

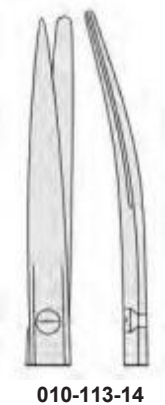

010-113-14



METZENBAUM
 14,5 cm, 5 3/4"

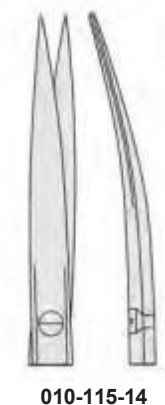

010-115-14







	<u>18,0 cm, 7"</u>	<u>010-110-18</u>
	<u>20,0 cm, 8"</u>	<u>010-110-20</u>
	<u>23,0 cm, 9"</u>	<u>010-110-23</u>
	<u>25,0 cm, 10"</u>	<u>010-110-25</u>
	<u>28,0 cm, 11"</u>	<u>010-110-28</u>
METZENBAUM	<u>30,0 cm, 12"</u>	<u>010-110-30</u>

	<u>18,0 cm, 7"</u>	<u>010-111-18</u>
	<u>20,0 cm, 8"</u>	<u>010-111-20</u>
	<u>23,0 cm, 9"</u>	<u>010-111-23</u>
	<u>25,0 cm, 10"</u>	<u>010-111-25</u>
	<u>28,0 cm, 11"</u>	<u>010-111-28</u>
METZENBAUM	<u>30,0 cm, 12"</u>	<u>010-111-30</u>

	<u>18,0 cm, 7"</u>	<u>010-112-18</u>
	<u>20,0 cm, 8"</u>	<u>010-112-20</u>
	<u>23,0 cm, 9"</u>	<u>010-112-23</u>
	<u>25,0 cm, 10"</u>	<u>010-112-25</u>
	<u>28,0 cm, 11"</u>	<u>010-112-28</u>
METZENBAUM	<u>30,0 cm, 12"</u>	<u>010-112-30</u>

	<u>18,0 cm, 7"</u>	<u>010-113-18</u>
	<u>20,0 cm, 8"</u>	<u>010-113-20</u>
	<u>23,0 cm, 9"</u>	<u>010-113-23</u>
	<u>25,0 cm, 10"</u>	<u>010-113-25</u>
	<u>28,0 cm, 11"</u>	<u>010-113-28</u>
METZENBAUM	<u>30,0 cm, 12"</u>	<u>010-113-30</u>

Präparierscheren
Dissecting Scissors
Tijeras de disección
Forbici per dissezione

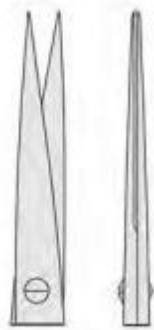

18,0 cm, 7"	010-114-18
20,0 cm, 8"	010-114-20
23,0 cm, 9"	010-114-23
25,0 cm, 10"	010-114-25
28,0 cm, 11"	010-114-28
30,0 cm, 12"	010-114-30

METZENBAUM

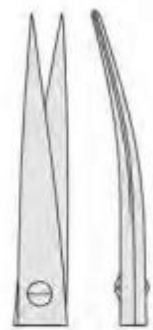

18,0 cm, 7"	010-115-18
20,0 cm, 8"	010-115-20
23,0 cm, 9"	010-115-23
25,0 cm, 10"	010-115-25
28,0 cm, 11"	010-115-28
30,0 cm, 12"	010-115-30

METZENBAUM

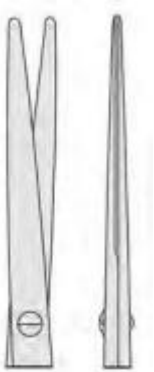

010-120-14

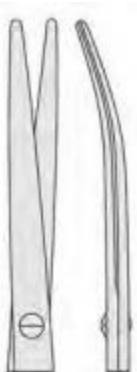

010-121-14

METZENBAUM-FINO
14,5 cm, 5³/₄"



18,0 cm, 7"	010-120-18
20,0 cm, 8"	010-120-20
23,0 cm, 9"	010-120-23
25,0 cm, 10"	010-120-25
28,0 cm, 11"	010-120-28
30,0 cm, 12"	010-120-30

METZENBAUM-FINO



18,0 cm, 7"	010-121-18
20,0 cm, 8"	010-121-20
23,0 cm, 9"	010-121-23
25,0 cm, 10"	010-121-25
28,0 cm, 11"	010-121-28
30,0 cm, 12"	010-121-30

METZENBAUM-FINO

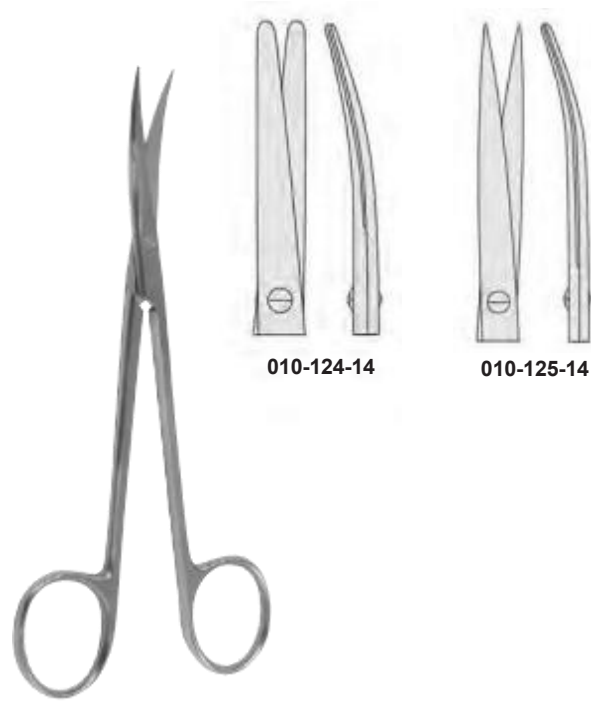

010-124-14

010-125-14

METZENBAUM-FINO
 14,5 cm, 5³/₄"



18,0 cm, 7"	010-124-18
20,0 cm, 8"	010-124-20
23,0 cm, 9"	010-124-23
25,0 cm, 10"	010-124-25
28,0 cm, 11"	010-124-28
30,0 cm, 12"	010-124-30

METZENBAUM-FINO



18,0 cm, 7"	010-125-18
20,0 cm, 8"	010-125-20
23,0 cm, 9"	010-125-23
25,0 cm, 10"	010-125-25
28,0 cm, 11"	010-125-28
30,0 cm, 12"	010-125-30

METZENBAUM-FINO

Präparierscheren
Dissecting Scissors
Tijeras de disección
Forbici per dissezione

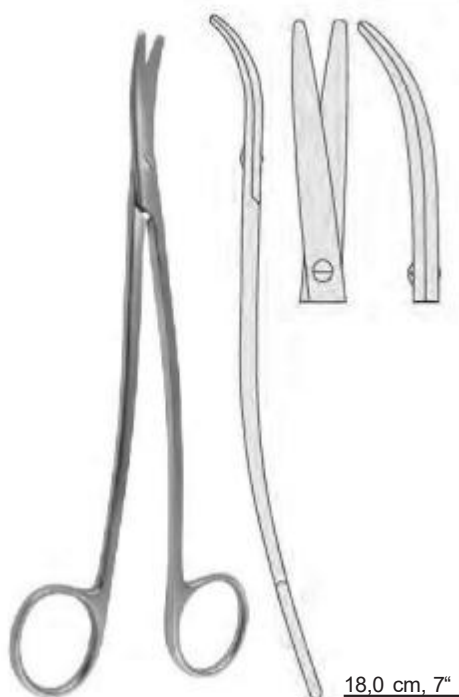

METZENBAUM-FINO S

18,0 cm, 7"	010-127-18
20,0 cm, 8"	010-127-20
23,0 cm, 9"	010-127-23

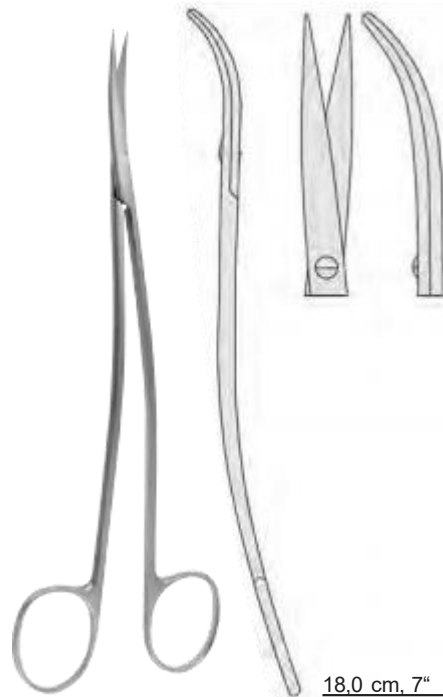

METZENBAUM-FINO S

18,0 cm, 7"	010-129-18
20,0 cm, 8"	010-129-20
23,0 cm, 9"	010-129-23



METZENBAUM-LAHEY
 14,0 cm, 5½" **010-137-14**

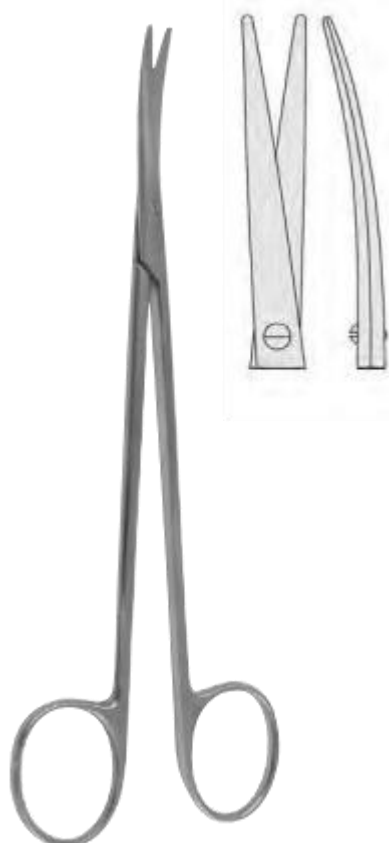

TOENNIS-ADSON
 17,0 cm, 6¾" **010-139-17**

Präparierscheren
Dissecting Scissors
Tijeras de disección
Forbici per dissezione

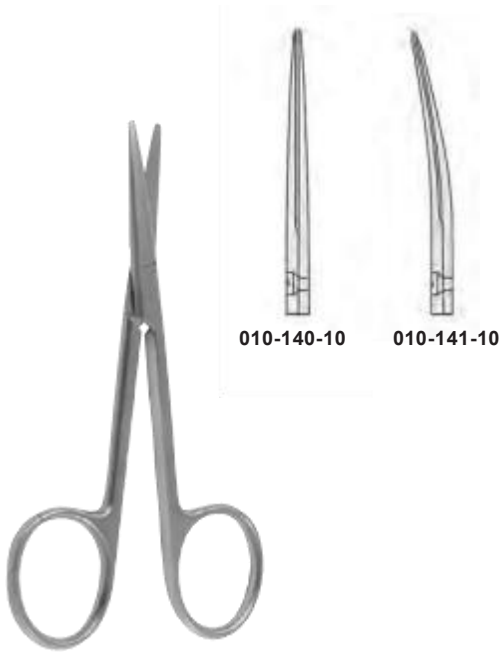

010-140-10 010-141-10

BABY-LEXER
10,0 cm, 4"

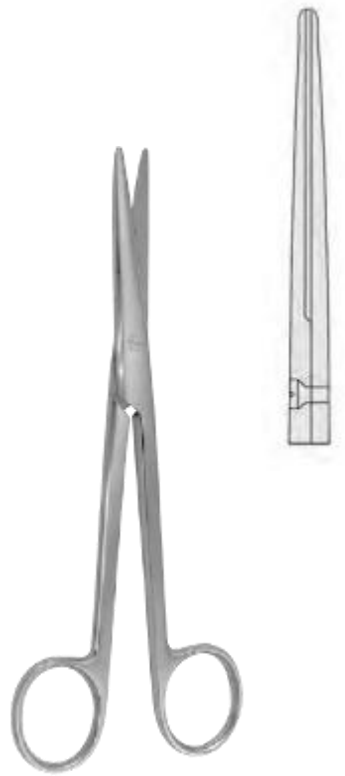

16,0 cm, 6¹/₄" **010-140-16**
21,0 cm, 8¹/₄" **010-140-21**

LEXER



16,0 cm, 6¹/₄" **010-141-16**
21,0 cm, 8¹/₄" **010-141-21**

LEXER

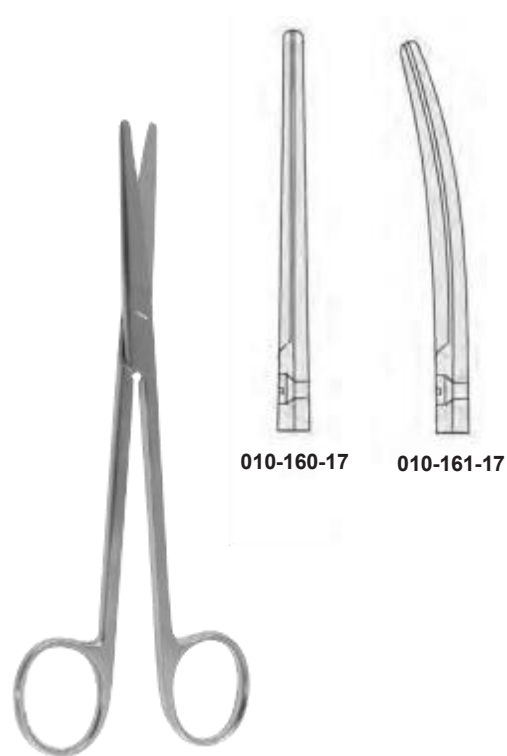

010-160-17 010-161-17

MIXTER
17,0 cm, 6³/₄"

Präparierscheren, feine chirurgische Scheren
Dissecting Scissors, fine surgical scissors
Tijeras de disección, tijeras finas para cirugía
Forbici per dissezione, forbici fine per chirurgia



12,0 cm, 4 ³ / ₄ "	010-200-12
15,0 cm, 6"	010-200-15
18,0 cm, 7"	010-200-18
20,0 cm, 8"	010-200-20

KILNER (RAGNELL)



12,0 cm, 4 ³ / ₄ "	010-201-12
15,0 cm, 6"	010-201-15
18,0 cm, 7"	010-201-18
20,0 cm, 8"	010-201-20

KILNER (RAGNELL)



15,0 cm, 6"	010-210-15
18,0 cm, 7"	010-210-18

REYNOLDS



15,0 cm, 6"	010-211-15
18,0 cm, 7"	010-211-18
20,0 cm, 8"	010-211-20
23,0 cm, 9"	010-211-23
25,0 cm, 10"	010-211-25

REYNOLDS

Feine chirurgische Scheren
 Fine surgical scissors
 Tijeras finas para cirugía
 Forbici fine per chirurgia



THOREK

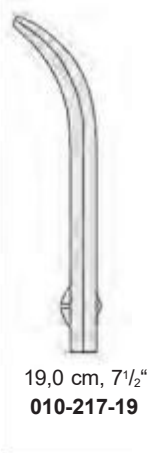

19,0 cm, 7½"
010-217-19



25,0 cm, 10"
010-217-25



15,0 cm, 6"



010-220-15



010-221-15

Nerv-Präparierscheren
 Nerve dissecting scissors
 Tijeras para nervios
 Forbici per dissezione dinervi



SANVENERO
 14,0 cm, 5½"

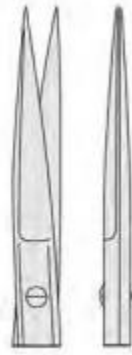

010-224-14

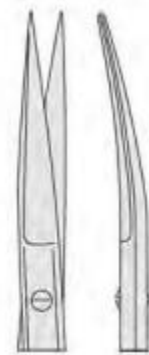

010-225-14



JOSEPH
 14,0 cm, 5½"

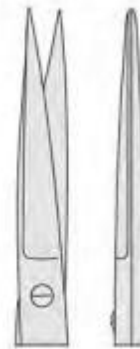

010-228-14

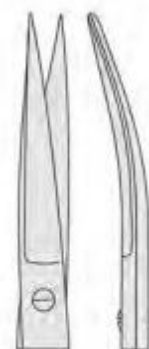

010-229-14

Feine chirurgische Scheren
 Fine surgical scissors
 Tijeras finas para cirugía
 Forbici fine per chirurgia



WAGNER
 12,0 cm, 4³/₄"



010-230-12

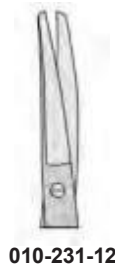

010-231-12

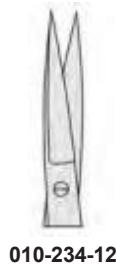

010-234-12



010-235-12



STRABISMUS
 11,5 cm, 4¹/₂"



010-240-11



010-241-11



IRIS

9,0 cm, 4¹/₈"
 10,5 cm, 4¹/₈"
 11,5 cm, 4¹/₂"

010-244-09
010-244-10
010-244-11



IRIS

9,0 cm, 4¹/₈"
 10,5 cm, 4¹/₈"
 11,5 cm, 4¹/₂"

010-245-09
010-245-10
010-245-11

Feine chirurgische Scheren
 Fine surgical scissors
 Tijeras finas para cirugía
 Forbici fine per chirurgia



10,5 cm, 4¹/₈" **010-250-10**
 11,5 cm, 4¹/₂" **010-250-11**

IRIS



10,5 cm, 4¹/₈" **010-251-10**
 11,5 cm, 4¹/₂" **010-251-11**

IRIS



11,5 cm, 4¹/₂"
010-261-11



11,5 cm, 4¹/₂"
010-263-11

Feine chirurgische Scheren
 Fine surgical scissors
 Tijeras finas para cirugía
 Forbici fine per chirurgia



12,0 cm, 4³/₄"



010-264-12



010-265-12



MOD. BONN
 8,0 cm, 3¹/₄"
 010-270-08



MOD. BONN
 8,0 cm, 3¹/₄"
 010-271-08



MOD. BONN
 8,0 cm, 3¹/₄"
 010-273-08

Feine chirurgische Scheren
 Fine surgical scissors
 Tijeras finas para cirugía
 Forbici fine per chirurgia



BROPHY (SULLIVAN)
 14,0 cm, 5½"
 010-276-14



BROPHY (SULLIVAN)
 14,0 cm, 5½"
 010-277-14



010-280-12 010-283-12 010-285-12

LANDOLT
 12,5 cm, 5"



10,5 cm, 4⅛" 010-290-10 010-291-10
 11,5 cm, 4½" 010-290-11 010-291-11

10,5 cm, 4⅛" 010-294-10 010-295-10
 11,5 cm, 4½" 010-294-11 010-295-11

STEVENS

Chirurgische Scheren
Surgical scissors
Tijeras para cirugía
Forbici per chirurgia



Inzisionsscheren
Incision scissors
Tijeras para incisión
Forbici vascolare e per fistole

13,0 cm, 5"
14,5 cm, 5³/₄"

010-300-13
010-300-14



RICHTER
14,5 cm, 5³/₄"
010-310-14



FERGUSON
16,5 cm, 6¹/₄"
18,0 cm, 7"

010-315-16
010-315-18

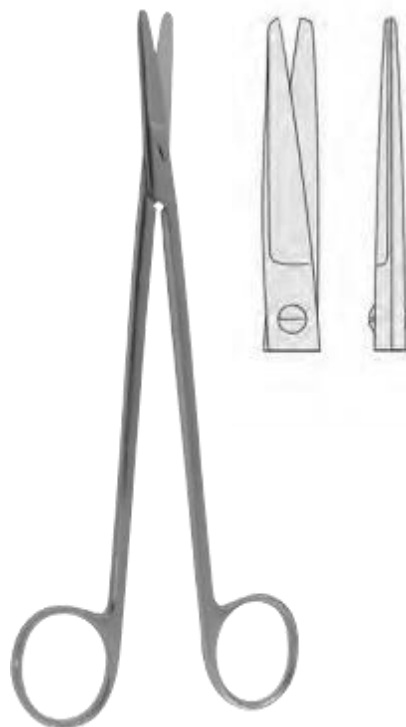

TOENNIS
18,0 cm, 7"
010-324-18

Chirurgische Scheren, Ligaturscheren
 Surgical scissors, Ligature Scissors
 Tijeras para cirugía, Tijeras para ligaduras
 Forbici per chirurgia, Forbici per legature

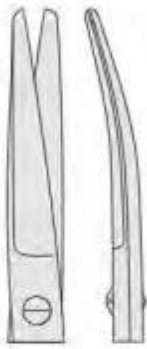

TOENNIS
 18,0 cm, 7"
 010-325-18



HALLE
 19,0 cm, 7½"
 010-341-19



FOMON
 15,0 cm, 6"
 010-343-15



SPENCER
 9,0 cm, 4 1/8" **010-400-09**
 10,5 cm, 4 1/8" **010-400-10**
 13,0 cm, 5" **010-400-13**



LITTAUER
 11,5 cm, 4 1/4" **010-402-11**
 14,0 cm, 5 1/2" **010-402-14**



BUCK

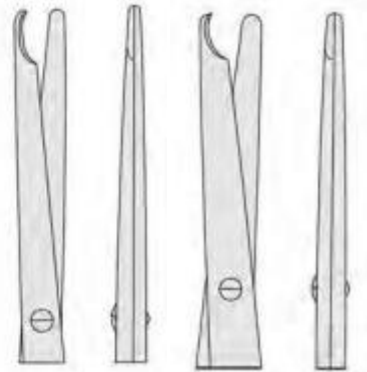

14,5 cm, 5 3/4"
 010-404-14

18,0 cm, 7"
 010-404-18

Ligaturscheren, Neurochirurgische Scheren
 Ligature Scissors, Neurosurgical Scissors
 Tijeras para ligaduras, Tijeras para Neurocirugia
 Forbici per legature, Forbici per Neurochirurgia

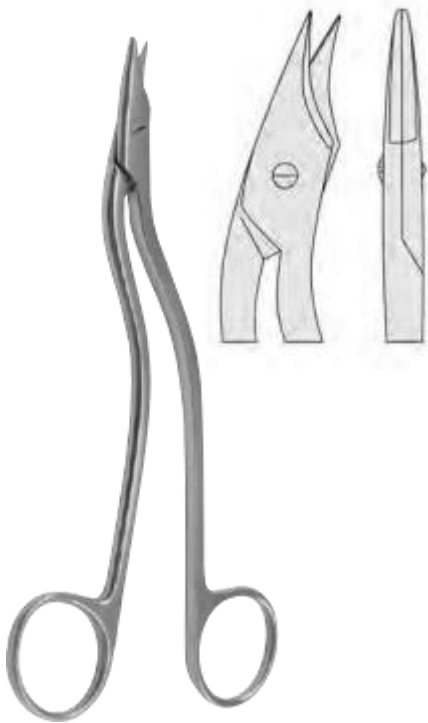

HEATH
 16,0 cm, 6¹/₄"
 010-408-16



NORTHBENT
 9,0 cm, 3¹/₂"
 010-411-19



NORTHBENT
 13,0 cm, 5"
 010-413-13



EISELSBERG
 12,0 cm, 4³/₄"
 010-415-12

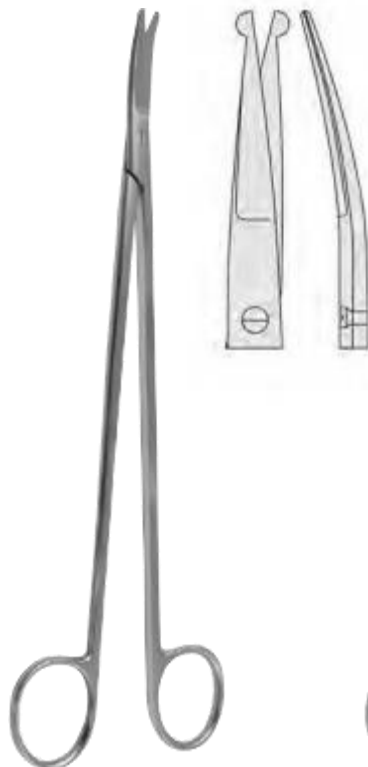

STRULLY
 22,0 cm, 8⁵/₈"
 010-450-22



DANDY
 17,0 cm, 6³/₄"
 010-453-17

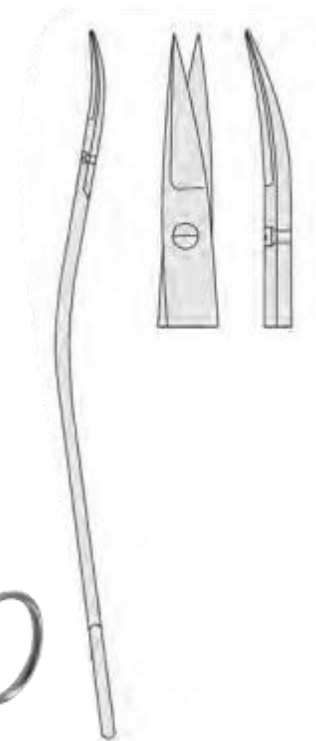

Neurochirurgische Scheren, Tonsillenscheren, Nasenscheren
 Neurosurgical Scissors, Tonsil Scissors, Nasal Scissors
 Tijeras para Neurocirugía, Tijeras para amígdalas, Tijeras para el tabique nasal
 Forbici per Neurochirurgia, Forbici per tonsille, Forbici per il setto nasale

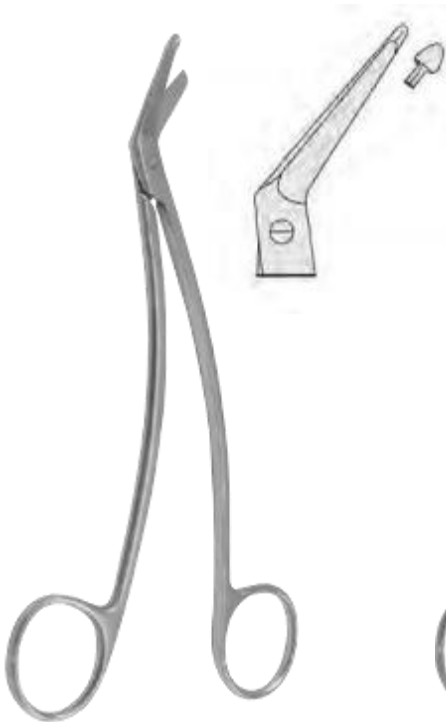

SCHMIEDEN-TAYLOR
 17,0 cm, 6³/₄"
 010-457-17



010-458-17 010-459-17

LINCOLN
 17,0 cm, 6³/₄"



HEYMANN
 18,0 cm, 7"
 010-501-18

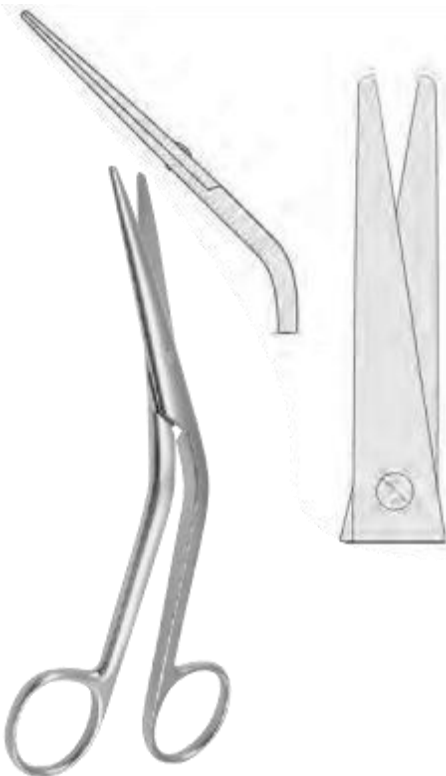

COTTLE
 16,0 cm, 6¹/₄"
 010-511-16



KIRSTEN
 18,0 cm, 7"
 010-517-18



CAPLAN
 22,0 cm, 8⁵/₈"
 010-519-22

Tonsillenscheren, Nasenscheren, Gefäßscheren
 Tonsil Scissors, Nasal Scissors, Vascular Scissors
 Tijeras para amígdalas, Tijeras para el tabique nasal, Tijeras vasculares
 Forbici per tonsille, Forbici per il setto nasale, Forbici vascolari



BOETTCHER
 18,0 cm, 7"
 010-521-18

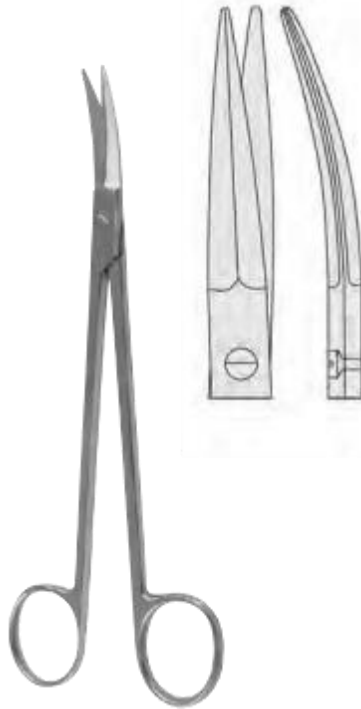

PRINCE
 17,5 cm, 6⁵/₈"
 010-523-17

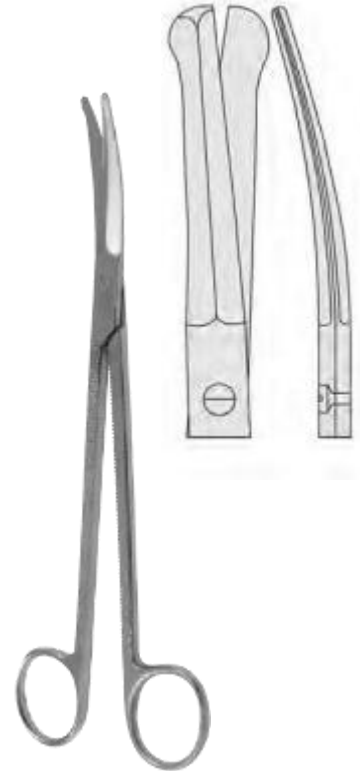

GOOD
 19,0 cm, 7¹/₂"
 010-525-19



CARTILAGE
 20,0 cm, 8"
 010-528-20



DE BAKEY

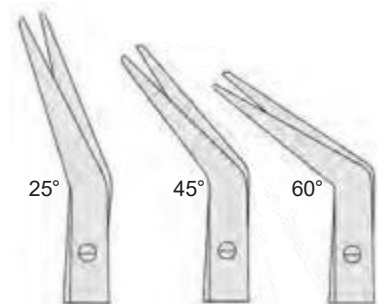

17,5 cm, 6 ⁵ / ₈ "	010-540-25	010-540-45	010-540-60
19,5 cm, 7 ³ / ₄ "	010-541-25	010-541-45	010-541-60
21,0 cm, 8 ¹ / ₄ "	010-542-25	010-542-45	010-542-60
23,0 cm, 9"	010-543-25	010-543-45	010-543-60
28,0 cm, 11"	010-544-25	010-544-45	010-544-60

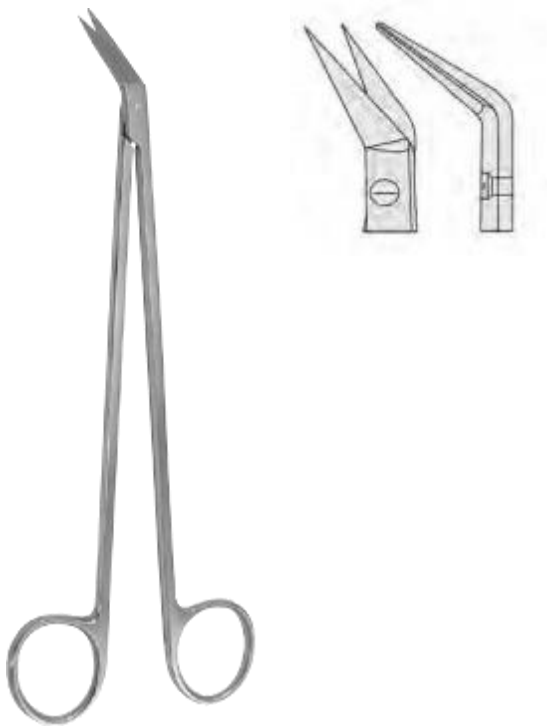

POTTS-SMITH
 18,0 cm, 7"
 010-547-18

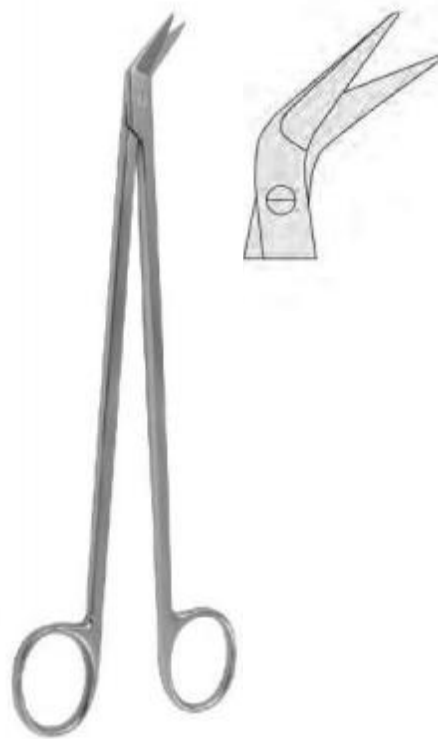

POTTS DE MARTEL
 21,0 cm, 8¹/₄" **010-548-21**
 24,0 cm, 9¹/₂" **010-548-24**



DIETRICH-HEGEMANN
 19,0 cm, 7¹/₂"

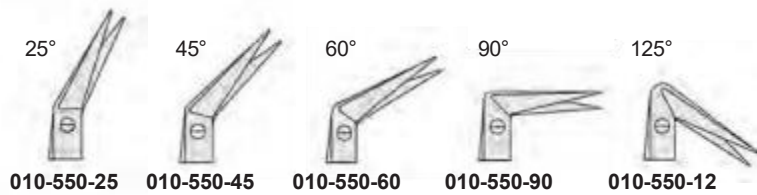

Gefäßscheren
 Vascular Scissors
 Tijeras vasculares
 Forbici vascolari



DIETRICH
 20,0 cm, 7 1/2"
 010-552-12



POTTS-SMITH
 19,0 cm, 7 1/2"

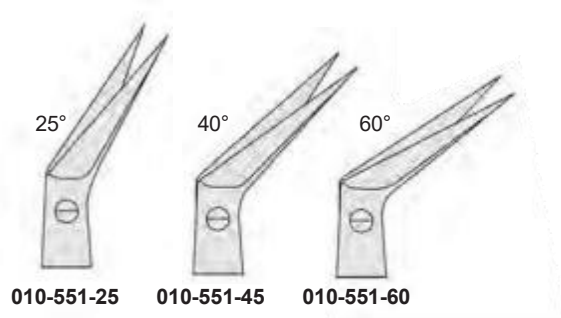

010-551-25 010-551-45 010-551-60



DE BAKEY
 15,5 cm, 6"
 010-560-15



DE BAKEY
 15,5 cm, 6"
 010-561-15



DE BAKEY
 15,5 cm, 6"
 010-562-15

Gefäßscheren, Gynäkologische Scheren
 Vascular Scissors, Gynecology scissors
 Tijeras vasculares, Tijeras para ginecología
 Forbici vascolari, Forbici per ginecologia



MC INDOE
 19,0 cm, 7½"
 010-570-19



geknöpftes Blatt
 probe-pointed blade
 punta botonda
 lame bottonuta

11,5 cm, 4½"
 010-572-11



CRAFOORD
 30,0 cm, 12"
 010-575-30



SATINSKY
 15,5 cm, 9⅝"
 010-577-24



KLINGENBERG-LOTH
 23,0 cm, 9"
 010-579-23



SIMS



20,0 cm, 8"	010-600-20	010-602-20	010-604-20
23,0 cm, 9"	010-600-23	010-602-23	010-604-23

Gynäkologische Scheren
 Gynecology scissors
 Tijeras para ginecología
 Forbici per ginecologia

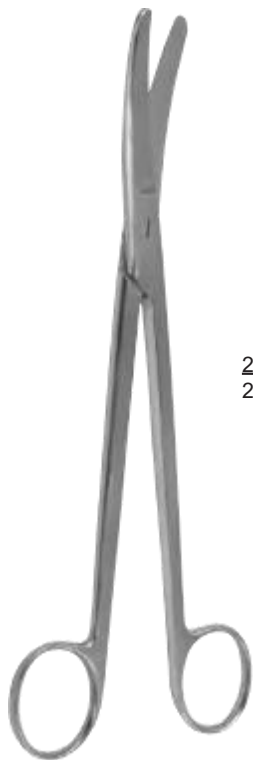

SIMS

20,0 cm, 8"	010-601-20	010-603-20	010-605-20
23,0 cm, 9"	010-601-23	010-603-23	010-605-23

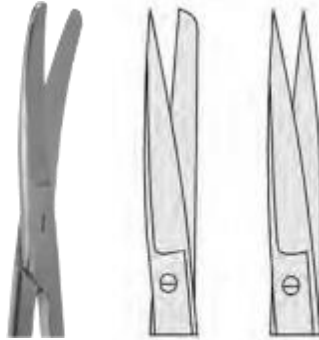

SIEBOLD
 24,0 cm, 9½"
010-620-24



BOZEMANN
 22,0 cm, 8¾"
010-622-22



DOYEN

16,0 cm, 6¼"	010-610-16	010-611-16	010-612-16
17,5 cm, 6⅝"	010-610-17	010-611-17	

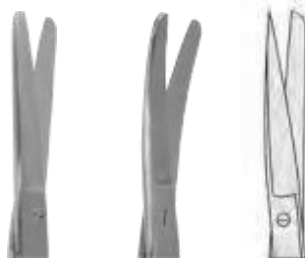

KELLY
 16,0 cm, 6¼" **010-634-16**
 18,0 cm, 7" **010-634-18**

Fistelscheren
 Fistula scissors
 Tijeras para fistulas
 Forbici per fistole

Gynäkologische Scheren, Darmscheren
 Gynecology scissors, Enterotomy Scissors
 Tijeras para ginecología, Tijeras enterótomos
 Forbici per ginecologia, Forbici per enterotomia



Fistelscheren
 Fistula scissors
 Tijeras para fistulas
 Forbici per fistole

KELLY

16,0 cm, 6¹/₄" **010-635-16**
 18,0 cm, 7" **010-635-18**



WERTHEIM

19,5 cm, 7³/₄" **010-640-19**
 22,5 cm, 8³/₄" **010-640-23**



010-651-18

DUBOIS

27,0 cm, 10⁵/₈"
010-650-18



21,0 cm, 8¹/₄"
010-670-21



21,0 cm, 8¹/₄"
010-672-21



21,0 cm, 8¹/₄"
010-674-21



LLOYD-DAVIES
 27,0 cm, 10⁵/₈"
010-677-27



Lungenlappen- und Rektumscheren, Lungenscheren, Dammscheren
Lobectomy and Rectal Scissors, Lobectomy Scissors, Episiotomy Scissors
Tijeras para lobectomía y recto, Tijera para lobectomía, Tijeras para episiotomía
Forbici per lobo polmonare e per il retto, Forbici per lobo, Forbici per episiotomia

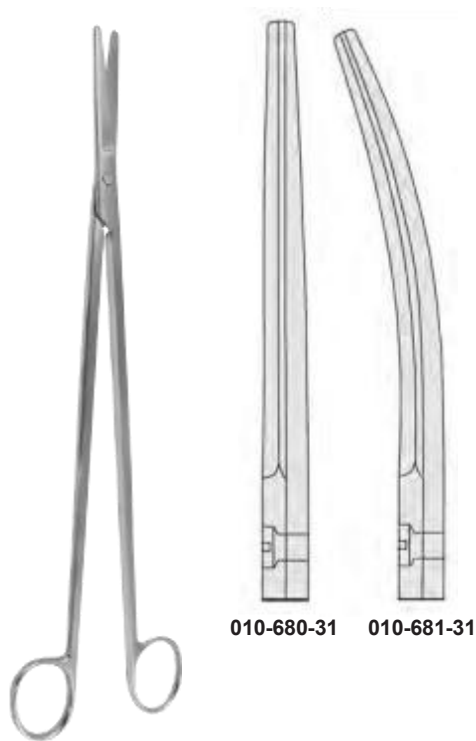

010-680-31 010-681-31

STELZNER
31,0 cm, 12³/₄"

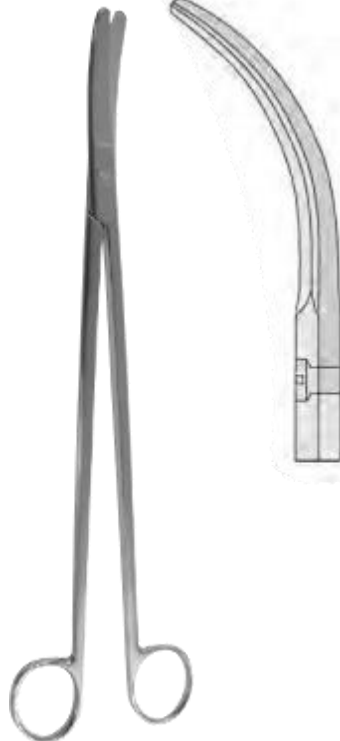

RECTAL
32,5 cm, 12³/₄"
010-685-32



WILLAUER
25,0 cm, 9³/₄" 010-688-25
28,0 cm, 11" 010-688-28

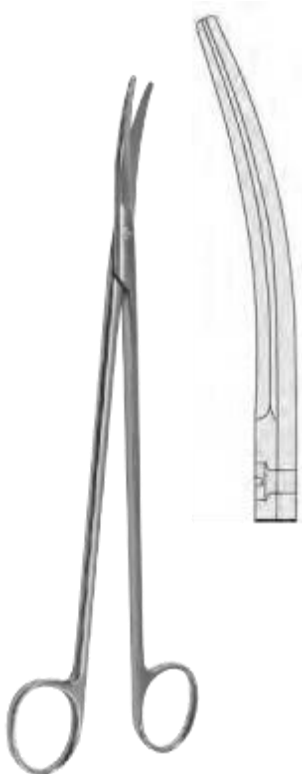

WILLAUER
25,0 cm, 9³/₄" 010-689-25
28,0 cm, 11" 010-689-28



POTTS-SMITH
19,0 cm, 7¹/₂"
010-691-19

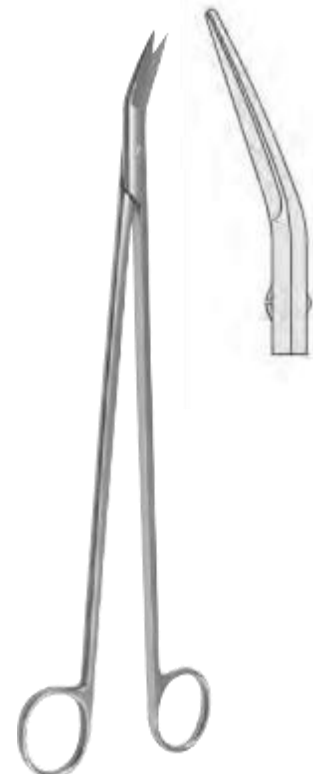

FINOCHIETTO
32,5 cm, 10³/₈"
010-693-27

Lungenscheren, Dammscheren, Nabelschnurscheren
 Lobectomy Scissors, Episiotomy Scissors, Umbilical Cord Scissors
 Tijera para lobectomía, Tijeras para episiotomía, Tijeras umbilicales
 Forbici per lobo, Forbici per episiotomia, Forbici ombelicali



WALDMANN
 18,0 cm, 7"
 010-695-18



BRAUN-STADLER
 14,5 cm, 5³/₄" 010-701-14
 20,0 cm, 8" 010-701-20



20,0 cm, 8"
 010-703-20



MOD. USA
 10,5 cm, 4¹/₈"
 010-706-10



BUSCH
 13,5 cm, 5³/₈" 010-707-13
 16,0 cm, 6¹/₄" 010-707-16



SCHUMACHER
 16,0 cm, 16¹/₄"
 010-709-16

Drahtscheren, Verband- und Kleiderstoffscheren
Wire Scissors, Bandage and Cloth Scissors
Cizallas corta-alambres, Tijeras para vendajes y tela
Forbici taglia cavo, Forbici per bendaggi e vestiti



gezahnt
serrated
dentada
dentata

UNIVERSAL
12,0 cm, 4³/₄"
010-800-12



LISTER

9,0 cm, 3 1/2"	010-900-09
11,0 cm, 4 ³ / ₈ "	010-900-11
14,0 cm, 5 ¹ / ₂ "	010-900-14
18,0 cm, 7"	010-900-18
20,0 cm, 8"	010-900-20



LISTER
18,5 cm, 7¹/₄" **010-901-18**
21,0 cm, 8¹/₄" **010-901-21**

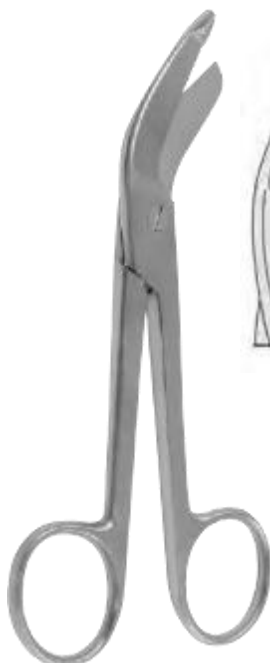

LISTER-EXCENTRIC
16,0 cm, 6¹/₄" **010-903-16**
19,0 cm, 7¹/₂" **010-903-19**

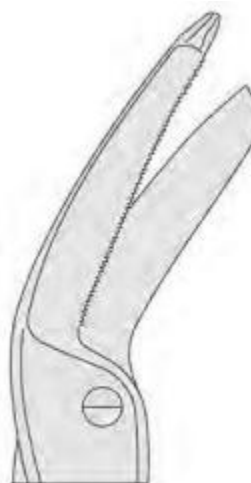

gezahnt
serrated
dentada
dentata



BERGMANN
23,0 cm, 9"
010-905-23

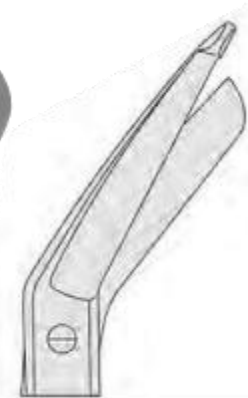

Verband- und Kleiderstoffscheren, Gipsscheren
 Bandage and Cloth Scissors, Plaster-of-Paris Shears
 Tijeras para vendajes y tela, Cizallas para escayolas
 Forbici per bendaggi e vestiti, Cesioie per gessi



ESMARCH
 20,0 cm, 8" **010-907-20**
 22,0 cm, 8⁵/₈" **010-907-22**



KNOWLES
 14,0 cm, 5¹/₂"
010-920-14

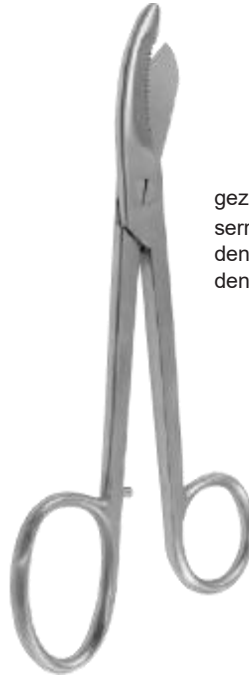

gezahnt
 serrated
 dentada
 dentata

BRUNS
 24,0 cm, 9¹/₂"
010-909-24
010-910-24



LORENZ
 23,0 cm, 9"
010-930-23

bis 134°C autoklavierbar
 autoclavable up to 134°C
 esté rilizable en autoclave hasta 134°C
 Sterilizabile in autoclave fino 134°C

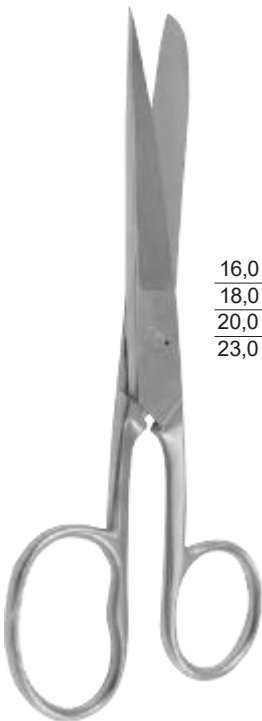

SMITH
 (MOD. USA)

16,0 cm, 6¹/₄" **010-940-16**
 18,0 cm, 7" **010-940-18**
 20,0 cm, 8" **010-940-20**
 23,0 cm, 9" **010-940-23**



gezahnt
 serrated
 dentada
 dentata

20,0 cm, 8"
010-941-20



gezahnt
 serrated
 dentada
 dentata

UNIVERSAL
 14,0 cm, 5¹/₂" **010-950-14**
 16,0 cm, 6¹/₄" **010-950-16**
 18,0 cm, 7" **010-950-18**

Chirurgische Scheren mit Hartmetallschneiden
 Surgical Scissors with tungsten carbide edges
 Tijeras para cirugía con filos de carburo tungsteno
 Forbici per chirurgia con lame in carburo di tungsteno



STANDARD
 14,5 cm, 5³/₄" 011-000-14
 16,5 cm, 6¹/₂" 011-000-16
 18,5 cm, 7¹/₄" 011-000-18



STANDARD
 14,5 cm, 5³/₄" 011-001-14
 16,5 cm, 6¹/₂" 011-001-16
 18,5 cm, 7¹/₄" 011-001-18



STANDARD
 14,5 cm, 5³/₄" 011-002-14
 16,5 cm, 6¹/₂" 011-002-16
 18,5 cm, 7¹/₄" 011-002-18



STANDARD
 14,5 cm, 5³/₄" 011-003-14
 16,5 cm, 6¹/₂" 011-003-16
 18,5 cm, 7¹/₄" 011-003-18



STANDARD
 14,5 cm, 5³/₄" 011-004-14
 16,5 cm, 6¹/₂" 011-004-16
 18,5 cm, 7¹/₄" 011-004-18



STANDARD
 14,5 cm, 5³/₄" 011-005-14
 16,5 cm, 6¹/₂" 011-005-16
 18,5 cm, 7¹/₄" 011-005-18

Chirurgische Scheren mit Hartmetallschneiden
 Surgical Scissors with tungsten carbide edges
 Tijeras para cirugía con filos de carburo tungsteno
 Forbici per chirurgia con lame in carburo di tungsteno



MAYO

14,5 cm, 5 ³ / ₄ "	011-100-14
17,0 cm, 6 ³ / ₄ "	011-100-17
23,0 cm, 9"	011-100-23



MAYO

14,5 cm, 5 ³ / ₄ "	011-101-14
17,0 cm, 6 ³ / ₄ "	011-101-17
23,0 cm, 9"	011-101-23



MAYO-STILLE

15,0 cm, 6"	011-102-15
17,0 cm, 6 ³ / ₄ "	011-102-17



MAYO-STILLE

15,0 cm, 6"	011-103-15
17,0 cm, 6 ³ / ₄ "	011-103-17



LEXER

16,0 cm, 6 ¹ / ₄ "	011-140-16
21,0 cm, 8 ¹ / ₄ "	011-140-21



LEXER

16,0 cm, 6 ¹ / ₄ "	011-141-16
21,0 cm, 8 ¹ / ₄ "	011-141-21

Präparierscheren mit Hartmetallschneiden
Dissecting Scissors with tungsten carbide edges
Tijeras para disección con filos de carburo tungsteno
Forbici per dissezione con lame in carburo di tungsteno

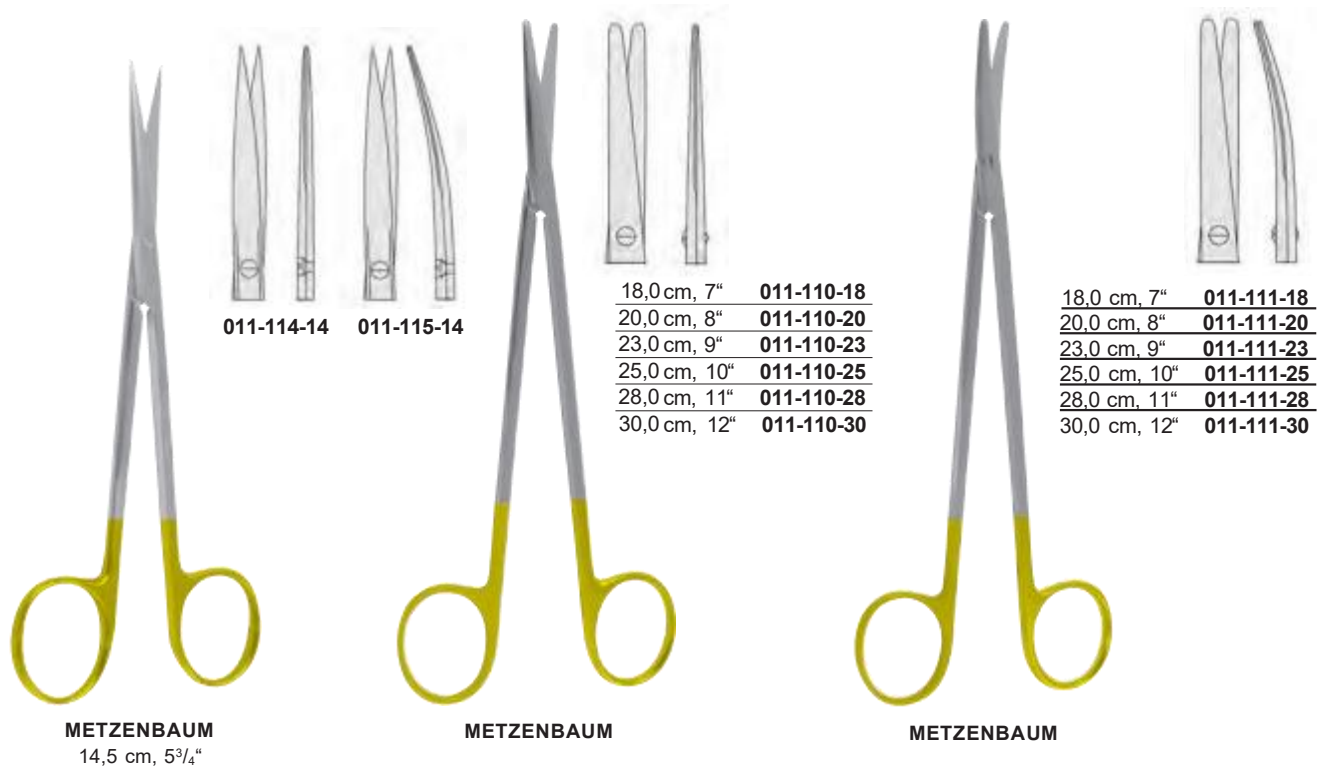
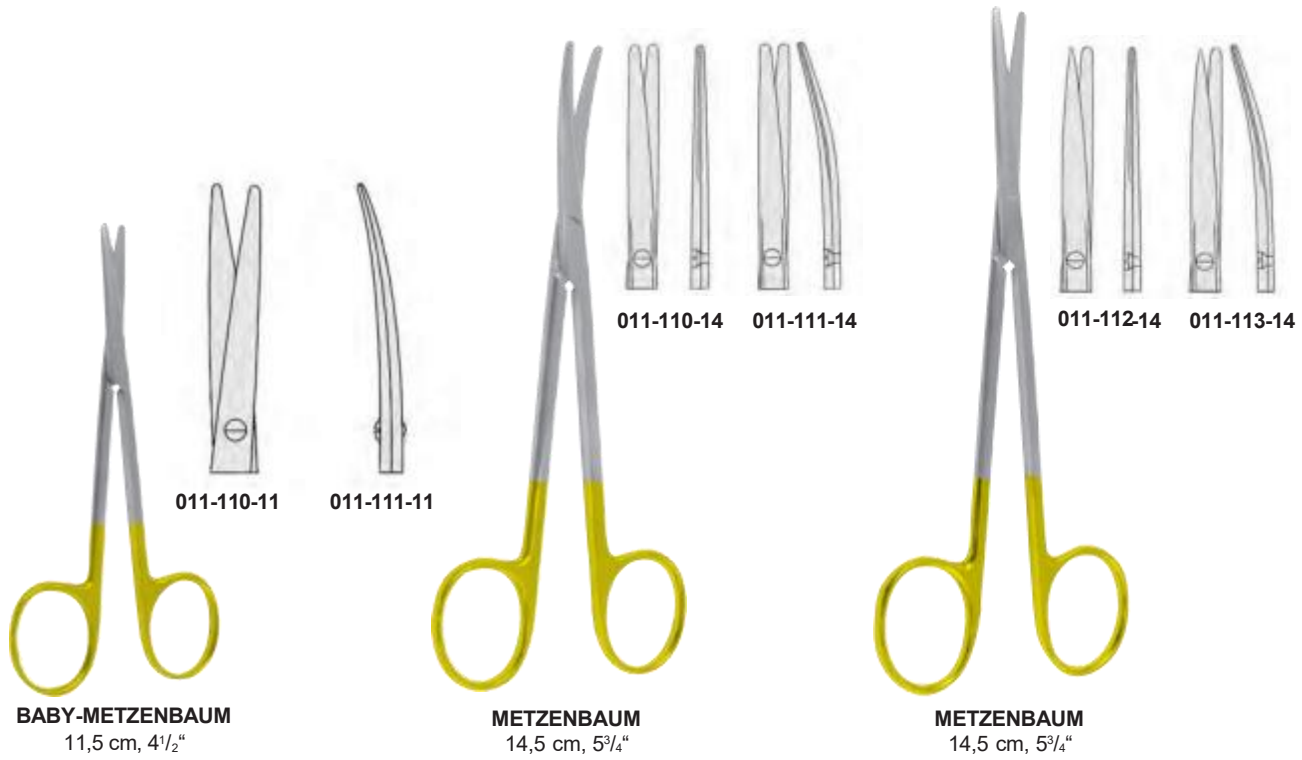

Präparierscheren mit Hartmetallschneiden
 Dissecting Scissors with tungsten carbide edges
 Tijeras para disección con filos de carburo tungsteno
 Forbici per dissezione con lame in carburo di tungsteno



18,0 cm, 7" **011-112-18**
 20,0 cm, 8" **011-112-20**
 23,0 cm, 9" **011-112-23**
 25,0 cm, 10" **011-112-25**
 28,0 cm, 11" **011-112-28**
 30,0 cm, 12" **011-112-30**

METZENBAUM

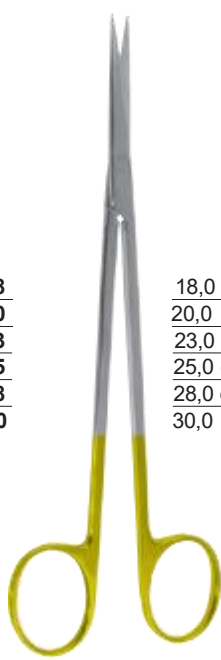

18,0 cm, 7" **011-113-18**
 20,0 cm, 8" **011-113-20**
 23,0 cm, 9" **011-113-23**
 25,0 cm, 10" **011-113-25**
 28,0 cm, 11" **011-113-28**
 30,0 cm, 12" **011-113-30**

METZENBAUM



18,0 cm, 7" **011-114-18**
 20,0 cm, 8" **011-114-20**
 23,0 cm, 9" **011-114-23**
 25,0 cm, 10" **011-114-25**
 28,0 cm, 11" **011-114-28**
 30,0 cm, 12" **011-114-30**

METZENBAUM



18,0 cm, 7" **011-115-18**
 20,0 cm, 8" **011-115-20**
 23,0 cm, 9" **011-115-23**
 25,0 cm, 10" **011-115-25**
 28,0 cm, 11" **011-115-28**
 30,0 cm, 12" **011-115-30**

METZENBAUM



011-120-14 **011-121-14**

METZENBAUM-FINO
 14,5 cm, 5¾"



011-124-14 **011-125-14**

METZENBAUM-FINO
 14,5 cm, 5¾"

Präparierscheren mit Hartmetallschneiden
Dissecting Scissors with tungsten carbide edges
Tijeras para disección con filos de carburo tungsteno
Forbici per dissezione con lame in carburo di tungsteno



18,0 cm, 7"	011-120-18
20,0 cm, 8"	011-120-20
23,0 cm, 9"	011-120-23
25,0 cm, 10"	011-120-25
28,0 cm, 11"	011-120-28
30,0 cm, 12"	011-120-30

METZENBAUM-FINO

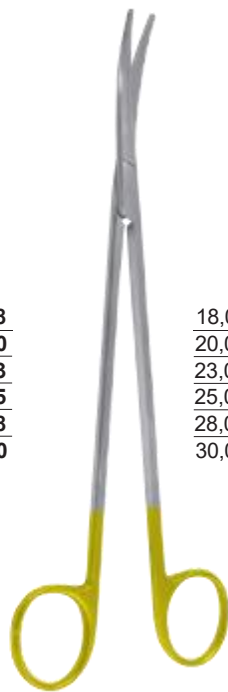

18,0 cm, 7"	011-121-18
20,0 cm, 8"	011-121-20
23,0 cm, 9"	011-121-23
25,0 cm, 10"	011-121-25
28,0 cm, 11"	011-121-28
30,0 cm, 12"	011-121-30

METZENBAUM-FINO



18,0 cm, 7"	011-124-18
20,0 cm, 8"	011-124-20
23,0 cm, 9"	011-124-23
25,0 cm, 10"	011-124-25
28,0 cm, 11"	011-124-28
30,0 cm, 12"	011-124-30

METZENBAUM-FINO



18,0 cm, 7"	011-125-18
20,0 cm, 8"	011-125-20
23,0 cm, 9"	011-125-23
25,0 cm, 10"	011-125-25
28,0 cm, 11"	011-125-28
30,0 cm, 12"	011-125-30

METZENBAUM-FINO



METZENBAUM-LAHEY
 14,0 cm, 5½"
011-137-14



TOENNIS-ADSON
 17,0 cm, 6¾"
011-139-17

Präparierscheren mit Hartmetallschneiden
 Dissecting Scissors with tungsten carbide edges
 Tijeras para disección con filos de carburo tungsteno
 Forbici per dissezione con lame in carburo di tungsteno



18,0 cm, 7" **011-127-18**
 20,0 cm, 8" **011-127-20**
 23,0 cm, 9" **011-127-23**

METZENBAUM-FINO S



18,0 cm, 7" **011-129-18**
 20,0 cm, 8" **011-129-20**
 23,0 cm, 9" **011-129-23**

METZENBAUM-FINO S

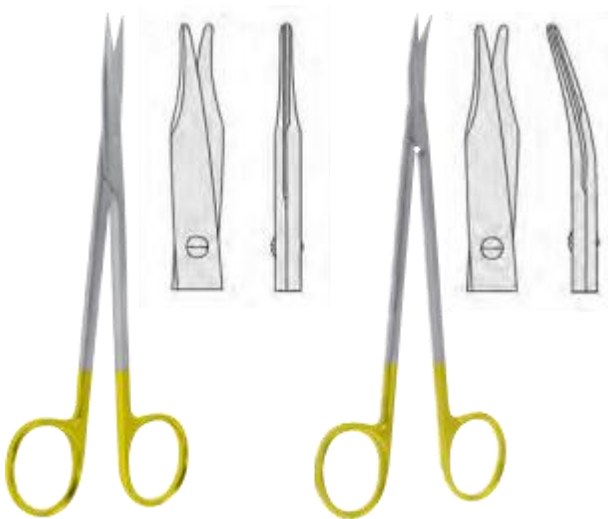

REYNOLDS
 15,0 cm, 6"
011-210-15



REYNOLDS
 15,0 cm, 6"
011-211-15



HYSTEREKTOMY
 25,5 cm, 10"
011-663-25

HYSTEREKTOMY
 25,0 cm, 9³/₄"
011-665-25

Gynäkologische Scheren mit Hartmetallschneiden
 Gynecology Scissors with tungsten carbide edges
 Tijeras para ginecología con filos de carburo tungsteno
 Forbici per ginecologia con lame in carburo di tungsteno



SIMS



20,0 cm, 8"	011-600-20	011-602-20	011-604-20
23,0 cm, 9"	011-600-23	011-602-23	011-604-23



SIMS

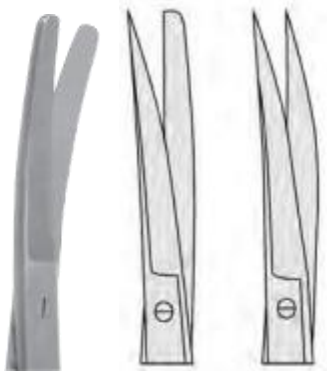

20,0 cm, 8"	011-601-20	011-603-20	011-605-20
23,0 cm, 9"	011-601-23	011-603-23	011-605-23

Gefäßscheren mit Hartmetallschneiden
 Vascular Scissors with tungsten carbide edges
 Tijeras vasculares con filos de carburo tungsteno
 Forbici vascolari con lame in carburo di tungsteno



DIETHRICH
 17,5 cm, 6⁷/₈"
 011-552-17



POTTS DE MARTEL
 24,0 cm, 9¹/₂"
 011-548-24



DE BAKEY

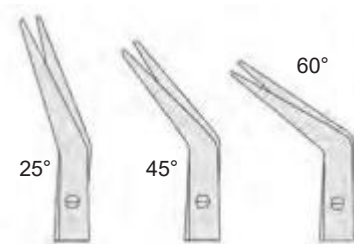

20,0 cm, 8"	011-543-25	011-543-45	011-543-60
23,0 cm, 9"	011-545-25	011-545-45	011-545-60

Gefäßscheren mit Hartmetallschneiden
Vascular Scissors with tungsten carbide edges
Tijeras vasculares con filos de carburo tungsteno
Forbici vascolari con lame in carburo di tungsteno



DIETRICH-HEGEMANN
18,0 cm, 7"



POTTS-SMITH
18,0 cm, 7 1/2"

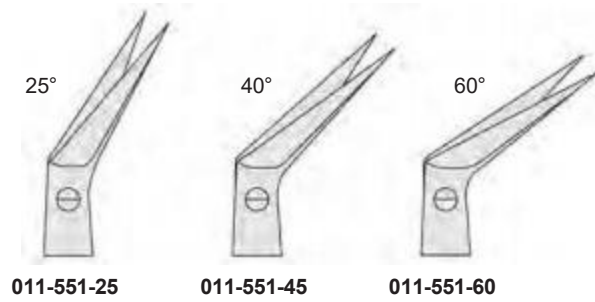

Scheren mit Hartmetallschneiden
 Scissors with tungsten carbide edges
 Tijeras con filos de carburo tungsteno
 Forbici con lame in carburo di tungsteno



IRIS
 11,5 cm, 4½"

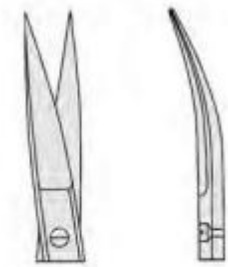

011-244-11 011-245-11



UNIVERSAL
 12,0 cm, 4¾"
 011-800-12

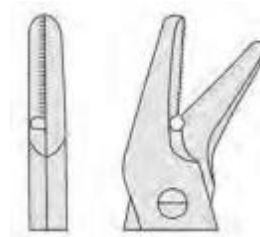

gezahnt
 serrated
 dentada
 dentata



LISTER
 18,0 cm, 7"
 011-900-18

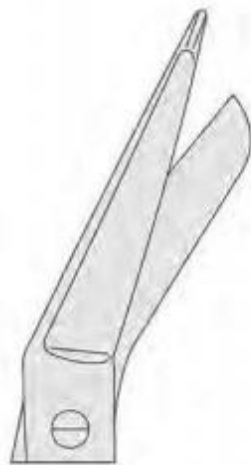

BRUNS
 24,0 cm, 9½"
 011-909-24

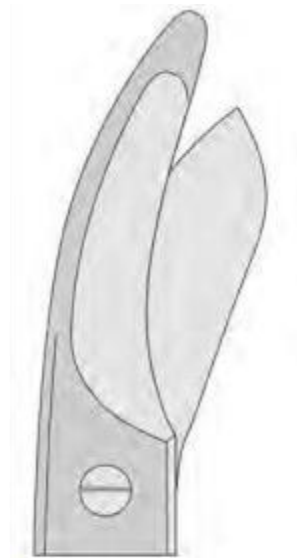

Super-Cut Scheren
 Super-Cut Scissors
 Tijeras Super-Cut
 Forbici Super-Cut



MAYO
 17,0 cm, 6³/₄"

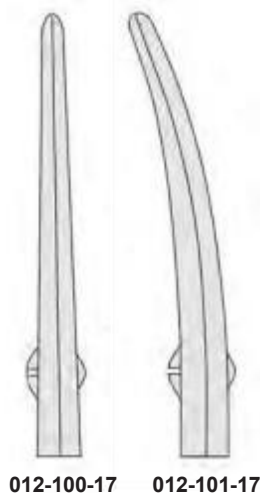

012-100-17 012-101-17

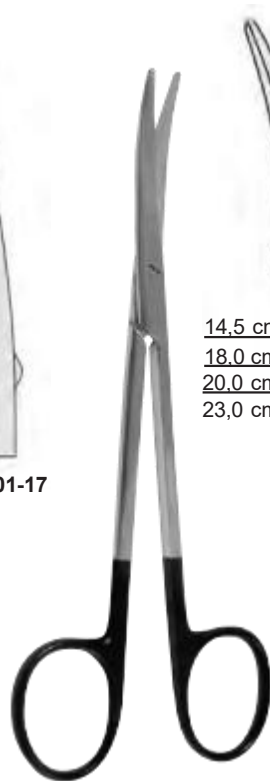

METZENBAUM

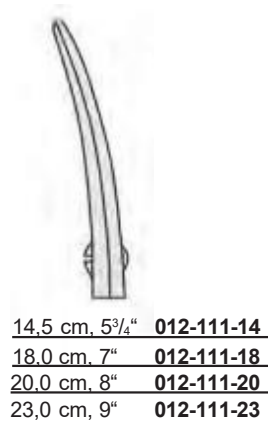

14,5 cm, 5³/₄" **012-111-14**
 18,0 cm, 7" **012-111-18**
 20,0 cm, 8" **012-111-20**
 23,0 cm, 9" **012-111-23**

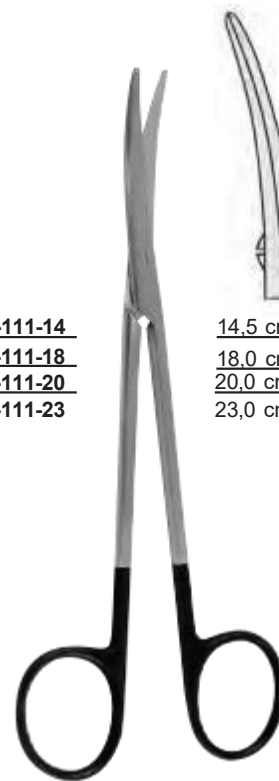

METZENBAUM-FINO

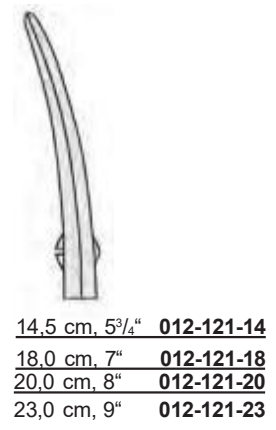

14,5 cm, 5³/₄" **012-121-14**
 18,0 cm, 7" **012-121-18**
 20,0 cm, 8" **012-121-20**
 23,0 cm, 9" **012-121-23**



KAYE FACE LIFT



15,0 cm, 6" **012-129-15**
 19,0 cm, 7¹/₂" **012-129-19**



JABALEY
 13,0 cm, 5"
012-130-13



TOENNIS-ADSON
 17,0 cm, 6³/₄"
012-139-17



STRABISMUS
 11,5 cm, 4½"



JAMISON
 15,0 cm, 6" **012-218-15**
 18,0 cm, 7" **012-218-18**



REYNOLDS
 12,5 cm, 5"
012-210-12



BABY-METZENBAUM
 11,0 cm, 4¾" **012-110-11**
 14,5 cm, 5¾" **012-110-14**



IRIS
 11,0 cm, 4¾"
012-244-11



IRIS
 11,0 cm, 4¾"
012-245-11



STEVENS TENOTOMY
 11,0 cm, 4¾"
012-290-11



STEVENS T ENOTOMY
 11,0 cm, 4¾"
012-291-11

Super-Cut Scheren
 Super-Cut Scissors
 Tijeras Super-Cut
 Forbici Super-Cut



gerade
straight

PAR TYPE
 12,0 cm, 4³/₄"
 012-200-12



gebogen
curved

PAR TYPE
 12,0 cm, 4³/₄"
 012-201-12



POTTS
 19,0 cm, 7¹/₂"



012-551-25



012-551-45



012-551-60





FOMON
 14,5 cm, 5³/₄"
 012-343-15



COTTLE
 16,5 cm, 6¹/₂"
 012-511-16





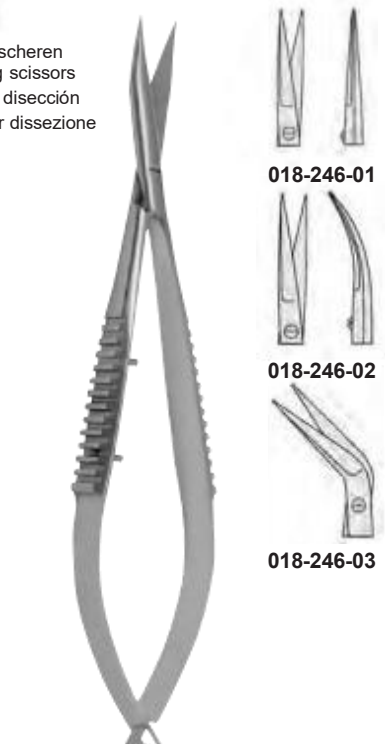







**Mikro-Scheren
Micro Scissors
Micro-Tijeras
Micro-Forbici**

 <p>018-081-11</p> <p>018-083-11</p>	 <p>gezahnt serrated dentada dentata</p> <p>018-241-14Z</p> <p>018-241-16Z</p>	 <p>Mikro-Präparierscheren Micro-dissecting scissors Micro-tijeras de disección Micro-forbici per dissezione</p> <p>018-243-14</p> <p>018-243-16</p>	 <p>018-246-01</p> <p>018-246-02</p> <p>018-246-03</p>
<p>WESTCOTT 11,0 cm, 4³/₈"</p>	<p>GOMEL 14,0 cm, 5¹/₂" 16,0 cm, 6¹/₄"</p>	<p>HEPP SCHEIDEL 14,0 cm, 5¹/₂" 16,0 cm, 6¹/₄"</p>	<p>18,5 cm, 7¹/₄"</p>



STEVENS

						
18,5 cm, 7 ¹ / ₄ "	018-290-01	018-290-02	018-290-03	018-290-04		
22,5 cm, 8 ³ / ₄ "	018-291-01	018-291-02	018-291-03	018-291-04		

			
18,5 cm, 7 ¹ / ₄ "	018-292-01	018-292-02	
22,5 cm, 8 ³ / ₄ "	018-293-01	018-293-02	

Mikro-Scheren, Mikro-Disektionsscheren
Micro Scissors, Micro Dissecting Scissors
Micro-Tijeras, Micro-Tijeras de disección
Micro-Forbici, Micro-Forbici per dissezione



18,0 cm, 7"



25°

018-270-25



45°

018-270-45

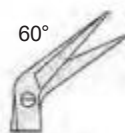

60°

018-270-60



90°

018-270-90



125°

018-270-12



25°

018-271-25

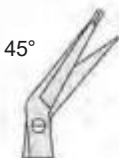

45°

018-271-45



60°

018-271-60



90°

018-271-90



125°

018-271-12



15,0 cm, 6"
018-223-15



15,0 cm, 6"
018-223-15Z

gezahnt
serrated
dentada
dentata



15,0 cm, 6"
018-201-15



18,0 cm, 7"
018-201-18



Mikro-Adventitiascheren
Micro Adventitia Scissors
Micro-Tijeras Adventitia
Micro-Forbici Adventitia



15,0 cm, 6"
018-232-15



15,0 cm, 6"
018-232-15Z

gezahnt
serrated
dentada
dentata



15,0 cm, 6"
018-203-15



18,0 cm, 7"
018-203-18



Pinzetten

Forceps

Pinzas

Pinze



Made in Pakistan

Anatomische Pinzetten
 Dissecting Forceps
 Pinzas de disección
 Pinze anatomiche per dissezione



STANDARD	
10,5 cm, 4 1/8"	020-002-10
11,5 cm, 4 1/2"	020-002-11
13,0 cm, 5"	020-002-13
14,5 cm, 5 3/4"	020-002-14
15,0 cm, 6"	020-002-15
16,0 cm, 6 1/4"	020-002-16
18,0 cm, 7"	020-002-18
20,0 cm, 8"	020-002-20
25,0 cm, 10"	020-002-25
30,0 cm, 12"	020-002-30



schmal
 narrow
 estrechos
 stretti

STANDARD	
10,5 cm, 4 1/8"	020-003-10
11,5 cm, 4 1/2"	020-003-11
13,0 cm, 5"	020-003-13
14,5 cm, 5 3/4"	020-003-14
15,0 cm, 6"	020-003-15
16,0 cm, 6 1/4"	020-003-16
18,0 cm, 7"	020-003-18
20,0 cm, 8"	020-003-20
25,0 cm, 10"	020-003-25
30,0 cm, 12"	020-003-30



schmal
 narrow
 estrechos
 stretti

STANDARD	
10,5 cm, 4 1/8"	020-004-10
11,5 cm, 4 1/2"	020-004-11
13,0 cm, 5"	020-004-13
14,5 cm, 5 3/4"	020-004-14
15,0 cm, 6"	020-004-15
16,0 cm, 6 1/4"	020-004-16
18,0 cm, 7"	020-004-18
20,0 cm, 8"	020-004-20
25,0 cm, 10"	020-004-25
30,0 cm, 12"	020-004-30



fein
 fine
 finas
 fini

STANDARD	
10,5 cm, 4 1/8"	020-010-10
11,5 cm, 4 1/2"	020-010-11
13,0 cm, 5"	020-010-13
14,5 cm, 5 3/4"	020-010-14
15,0 cm, 6"	020-010-15
16,0 cm, 6 1/4"	020-010-16
18,0 cm, 7"	020-010-18
20,0 cm, 8"	020-010-20
25,0 cm, 10"	020-010-25
30,0 cm, 12"	020-010-30

Anatomische Pinzetten
 Dissecting Forceps
 Pinzas de disección
 Pinze anatomiche per dissezione



fein
 fine
 finas
 fini
 тонкие



fein
 fine
 finas
 fini

mit Stift
 with pin
 con perno
 con espiga

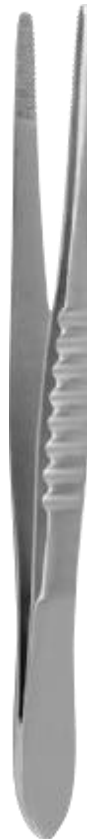

schmal
 narrow
 estrechos
 stretti
 узкие



- 10,5 cm, 4¹/₈" **020-011-10**
- 11,5 cm, 4¹/₂" **020-011-11**
- 13,0 cm, 5" **020-011-13**
- 14,5 cm, 5³/₄" **020-011-14**
- 16,0 cm, 6¹/₄" **020-011-16**
- 18,0 cm, 7" **020-011-18**
- 20,0 cm, 8" **020-011-20**
- 25,0 cm, 10" **020-011-25**
- 30,0 cm, 12" **020-011-30**

- 10,5 cm, 4¹/₈" **020-018-10**
- 11,5 cm, 4¹/₂" **020-018-11**
- 13,0 cm, 5" **020-018-13**
- 14,5 cm, 5³/₄" **020-018-14**
- 16,0 cm, 6¹/₄" **020-018-16**
- 18,0 cm, 7" **020-018-18**
- 20,0 cm, 8" **020-018-20**
- 25,0 cm, 10" **020-018-25**
- 30,0 cm, 12" **020-018-30**

- MOD. USA**
- 12,0 cm, 4³/₄" **020-006-10**
 - 13,0 cm, 5" **020-006-13**
 - 14,5 cm, 5³/₄" **020-006-14**
 - 15,0 cm, 6" **020-006-15**
 - 18,0 cm, 7" **020-006-18**
 - 20,0 cm, 8" **020-006-20**
 - 25,5 cm, 10" **020-006-25**
 - 30,0 cm, 12" **020-006-30**

- MOD. USA**
- 12,0 cm, 4³/₄" **020-012-11**
 - 13,0 cm, 5" **020-012-13**
 - 14,5 cm, 5³/₄" **020-012-14**
 - 15,0 cm, 6" **020-012-15**
 - 18,0 cm, 7" **020-012-18**
 - 20,0 cm, 8" **020-012-20**
 - 25,5 cm, 10" **020-012-25**

Anatomische Pinzetten
 Dissecting Forceps
 Pinzas de disección
 Pinze anatomiche per dissezione



ADSON
 12,0 cm, 4³/₄" 020-070-12
 15,0 cm, 6" 020-070-15



MICRO-ADSON
 12,0 cm, 4³/₄" 020-076-12
 15,0 cm, 6" 020-076-15



STILLE
 15,0 cm, 6"
 020-008-15



MC INDOE
 15,0 cm, 6"
 020-158-15



TAYLOR
 17,5 cm, 6⁵/₈"
 020-114-17



TAYLOR
 17,5 cm, 6⁵/₈"
 020-115-17



TAYLOR
 18,5 cm, 7¹/₄"
 020-117-18



GERALD
 18,0 cm, 7"
 020-102-18

Anatomische Pinzetten
 Dissecting Forceps
 Pinzas de disección
 Pinze anatomiche per dissezione



GERALD
 18,0 cm, 7"
020-103-18



POTTS-SMITH
18,0 cm, 7" 020-026-18
21,0 cm, 8¹/₄" 020-026-21
25,0 cm, 10" 020-026-25



POTTS-SMITH
18,0 cm, 7" 020-027-18
21,0 cm, 8¹/₄" 020-027-21
25,0 cm, 10" 020-027-25



SEMKEN
12,5 cm, 5" 020-040-12
15,0 cm, 6" 020-040-15



CUSHING
 17,5 cm, 6⁵/₈"
020-092-17



CUSHING
 17,5 cm, 6⁵/₈"
020-093-17



BROPHY
 20,0 cm, 8"
020-094-20

Anatomische Pinzetten
 Dissecting Forceps
 Pinzas de disección
 Pinze anatomiche per dissezione
 Пинцеты анатомические



BROPHY
 20,0 cm, 8"
 020-095-20



BONNEY
 18,0 cm, 7"
 020-120-18



SINGLE-TUTTLE
 23,0 cm, 9"
 020-516-23



DENNIS BROWN
 20,0 cm, 8"
 020-126-20



DUEHRSSSEN
 20,0 cm, 8"
 020-470-20



WAUGH
 15,0 cm, 6" 020-130-15
 20,0 cm, 8" 020-130-20



RAMSEY
 18,0 cm, 7"
 020-136-18

Chirurgische Pinzetten
Tissue Forceps
Pinzas quirúrgicas
Pinze per chirurgia

 1 x 2



STANDARD

10,5 cm, 4 ¹ / ₈ "	020-200-10
11,5 cm, 4 ¹ / ₂ "	020-200-11
13,0 cm, 5"	020-200-13
14,5 cm, 5 ³ / ₄ "	020-200-14
15,0 cm, 6"	020-200-15
16,0 cm, 6 ¹ / ₄ "	020-200-16
18,0 cm, 7"	020-200-18
20,0 cm, 8"	020-200-20
25,0 cm, 10"	020-200-25
30,0 cm, 12"	020-200-30

 2 x 3



11,5 cm, 4 ¹ / ₂ "	020-252-11
13,0 cm, 5"	020-252-13
14,5 cm, 5 ³ / ₄ "	020-252-14
16,0 cm, 6 ¹ / ₄ "	020-252-16
18,0 cm, 7"	020-252-18
20,0 cm, 8"	020-252-20
25,0 cm, 10"	020-252-25
30,0 cm, 12"	020-252-30

 3 x 4



13,0 cm, 5"	020-254-13
14,5 cm, 5 ³ / ₄ "	020-254-14
16,0 cm, 6 ¹ / ₄ "	020-254-16
18,0 cm, 7"	020-254-18
20,0 cm, 8"	020-254-20

 4 x 5



13,0 cm, 5"	020-256-13
14,5 cm, 5 ³ / ₄ "	020-256-14
16,0 cm, 6 ¹ / ₄ "	020-256-16
18,0 cm, 7"	020-256-18
20,0 cm, 8"	020-256-20

Chirurgische Pinzetten
 Tissue Forceps
 Pinzas quirúrgicas
 Pinze per chirurgia
 Пинцеты хирургические

fein
 fine
 finas
 fini

mit Stift
 with pin
 con perno
 con espiga

mit Stift
 with pin
 con perno
 con espiga

englische Modelle
 english patterns
 modelosingleses
 modelli inglese

 1 x 2

1 x 2

1 x 2

1 x 2



13,0 cm, 5" 020-210-13
14,5 cm, 5³/₄" 020-210-14
15,5 cm, 6" 020-210-15
16,0 cm, 6¹/₄" 020-210-16
18,0 cm, 7" 020-210-18
20,0 cm, 8" 020-210-20
25,0 cm, 10" 020-210-25
30,0 cm, 12" 020-210-30

13,0 cm, 5" 020-218-13
14,5 cm, 5³/₄" 020-218-14
15,5 cm, 6" 020-218-15
16,0 cm, 6¹/₄" 020-218-16
18,0 cm, 7" 020-218-18
20,0 cm, 8" 020-218-20
25,0 cm, 10" 020-218-25
30,0 cm, 12" 020-218-30

13,0 cm, 5" 020-219-13
14,5 cm, 5³/₄" 020-219-14
16,0 cm, 6¹/₄" 020-219-16
18,0 cm, 7" 020-219-18
20,0 cm, 8" 020-219-20

13,0 cm, 5" 020-236-13
14,5 cm, 5³/₄" 020-236-14
15,0 cm, 6" 020-236-15

1 x 2



2 x 3



1 x 2



1 x 2



MOD. USA

12,0 cm, 4 ³ / ₄ "	020-206-12
13,0 cm, 5"	020-206-13
14,5 cm, 5 ³ / ₄ "	020-206-14
15,5 cm, 6"	020-206-15
18,0 cm, 7"	020-206-18
20,0 cm, 8"	020-206-20
25,0 cm, 10"	020-206-25
30,0 cm, 12"	020-206-30

MOD. USA

12,0 cm, 4 ³ / ₄ "	020-212-12
13,0 cm, 5"	020-212-13
14,5 cm, 5 ³ / ₄ "	020-212-14
15,5 cm, 6"	020-212-15
18,0 cm, 7"	020-212-18
20,0 cm, 8"	020-212-20
25,0 cm, 10"	020-212-25
30,0 cm, 12"	020-212-30

ADSON

12,0 cm, 4 ³ / ₄ "	020-270-12
15,0 cm, 6"	020-270-15

MICRO-ADSON

12,0 cm, 4 ³ / ₄ "	020-276-12
15,0 cm, 6"	020-276-15

Chirurgische Pinzetten
 Tissue Forceps
 Pinzas quirúrgicas
 Pinze per chirurgia
 Пинцеты хирургические



ADSON
 12,0 cm, 4³/₄" **020-074-12**
 15,0 cm, 6" **020-074-15**



ADSON-BROWN
 12,0 cm, 4³/₄" **020-288-12**
 15,0 cm, 6" **020-288-15**



ADSON
 12,0 cm, 4³/₄" **020-282-12**



STILLE
 15,0 cm, 6" **020-208-15**



STILLE
 15,0 cm, 6" **020-209-15**



GILLIES
 15,0 cm, 6" **020-300-15**



ADLERKREUTZ
 15,0 cm, 6" **020-382-15**
 20,0 cm, 8" **020-382-20**



ADLERKREUTZ
 15,0 cm, 6" **020-384-15**
 20,0 cm, 8" **020-384-20**

Chirurgische Pinzetten
Tissue Forceps
Pinzas quirúrgicas
Pinze per chirurgia

1 x 2



SEMKEN
12,5 cm, 5" **020-240-12**
15,5 cm, 6" **020-240-15**

2 x 3



SEMKEN
12,5 cm, 5" **020-242-12**

1 x 2



MC INDOE
15,0 cm, 6" **020-358-15**

1 x 2



TAYLOR
17,5 cm, 6⁵/₈" **020-314-17**

1 x 2



TAYLOR
17,5 cm, 6⁵/₈" **020-315-17**

1 x 2



TAYLOR
17,5 cm, 6⁵/₈" **020-317-17**

1 x 2



GERALD
18,0 cm, 7" **020-302-18**

1 x 2



GERALD
18,0 cm, 7" **020-303-18**

Chirurgische Pinzetten
 Tissue Forceps
 Pinzas quirúrgicas
 Pinze per chirurgia

1 x 2



CUSHING
 17,5 cm, 6⁵/₈"
 020-292-17

1 x 2



CUSHING
 17,5 cm, 6⁵/₈"
 020-293-17

1 x 2



POTTS-SMITH
18,0 cm, 7" 020-226-18
21,0 cm, 8¹/₄" 020-226-21
 25,0 cm, 10" 020-226-25

1 x 2



WAUGH
 15,0 cm, 6" 020-330-15
 20,0 cm, 8" 020-330-20

1 x 2



BROPHY
 20,0 cm, 8"
 020-294-20



RUSS. MODELL
15,0 cm, 6" 020-456-15
20,0 cm, 8" 020-456-20
 25,0 cm, 10" 020-456-25



Chirurgische Pinzetten
Tissue Forceps
Pinzas quirúrgicas
Pinze per chirurgia



DURANTE
14,5 cm, 5³/₄" **020-460-14**
16,0 cm, 6¹/₄" **020-460-16**
20,0 cm, 8" **020-460-20**



DUEHRSSEN
20,0 cm, 8"



NELSON
15,0 cm, 6" **020-518-15**
20,0 cm, 8" **020-518-20**
23,0 cm, 9" **020-518-23**



DUVAL
14,0 cm, 5¹/₂"



COLLIN-DUVAL
20,0 cm, 8"

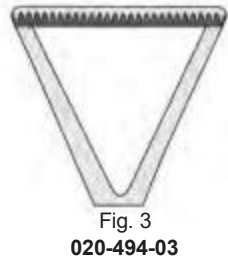

Chirurgische Pinzetten
 Tissue Forceps
 Pinzas quirúrgicas
 Pinze per chirurgia

1 x 2



LANE
 14,5 cm, 5³/₄" **020-420-14**
 20,0 cm, 8" **020-420-20**

2 x 3



LANE
 14,5 cm, 5³/₄" **020-422-14**
 20,0 cm, 8" **020-422-20**

7 x 7



BROWN
 15,0 cm, 6" **020-410-15**
 20,0 cm, 8" **020-410-20**
 25,0 cm, 10" **020-410-25**

. x 2



020-510-13
TREVE020-510-15
 13,0 cm, 5"
 15,0 cm, 6"

1 x 2



RAMSEY
 18,0 cm, 7"
020-520-18

2 x 3



RAMSEY
 18,0 cm, 7"
020-522-18

1 x 2



RAMSEY
 18,0 cm, 7"
020-590-18

2 x 3



RAMSEY
 18,0 cm, 7"
020-592-18

**Splitterpinzetten
Splinter Forceps
Pinzas para espigas
Pinze per schegge**

mit Stift
with pin
con perno
con espiga

mit Stift
with pin
con perno
con espiga



8,0 cm, 3 1/4" 020-662-08
9,0 cm, 3 1/2" 020-662-09
10,5 cm, 4 1/8" 020-662-10
11,5 cm, 4 1/2" 020-662-11
13,0 cm, 5" 020-662-13
14,5 cm, 5 1/2" 020-662-14



8,0 cm, 3 1/4" 020-663-08
9,0 cm, 3 1/2" 020-663-09
10,5 cm, 4 1/8" 020-663-10
11,5 cm, 4 1/2" 020-663-11
13,0 cm, 5" 020-663-13
14,5 cm, 5 1/2" 020-663-14



8,0 cm, 3 1/4" 020-666-08
9,0 cm, 3 1/2" 020-666-09
10,5 cm, 4 1/8" 020-666-10
11,5 cm, 4 1/2" 020-666-11
13,0 cm, 5" 020-666-13
14,5 cm, 5 1/2" 020-666-14



8,0 cm, 3 1/4" 020-667-08
9,0 cm, 3 1/2" 020-667-09
10,5 cm, 4 1/8" 020-667-10
11,5 cm, 4 1/2" 020-667-11
13,0 cm, 5" 020-667-13
14,5 cm, 5 1/2" 020-667-14

Splitterpinzetten, Mikro-Pinzetten
 Splinter Forceps, Micro Forceps
 Pinzas para espinas, Pinzas para microscopia
 Pinze per schegge, Pinze per microscopia



HUNTER
 10,5 cm, 4 1/4"
 020-652-10



HUNTER
 10,5 cm, 4 1/4"
 020-653-10



WALTER-CARMALT
 10,5 cm, 4 1/4"
 020-656-10



WALTER-CARMALT
 10,5 cm, 4 1/4"
 020-657-10



FEILCHENFELD
 7,5 cm, 3 1/8" 020-650-07
 9,0 cm, 3 1/2" 020-650-09
 11,5 cm, 4 1/2" 020-650-11



10,0 cm, 4"
 020-806-10



10,0 cm, 4"
 020-807-10

Mikro-Pinzetten
Micro Forceps
Pinzas para microscopia
Pinze per microscopia



GRAEFE
10,0 cm, 4"
020-810-10



GRAEFE
10,0 cm, 4"
020-811-10



GRAEFE
10,0 cm, 4"
020-813-10



GRAEFE
10,0 cm, 4"
020-814-10



GRAEFE
10,0 cm, 4"
020-815-10



GRAEFE
10,0 cm, 4"
020-817-10

Uhrmacher Pinzetten
 Jeweller's Forceps
 Pinzas de relojeroa
 Pinze per orologiaio



Fig. 3
 11,5 cm, 4 1/2"
 020-601-03



Fig. 4
 11,5 cm, 4 1/2"
 020-601-04



Fig. 5
 11,5 cm, 4 1/2"
 020-601-05



Fig. 7
 11,5 cm, 4 1/2"
 020-601-07

0,3 mm x 45°

0,3 mm x 90°

0,3 mm

0,3 mm x 45°



9 mm

11,0 cm, 4 3/8"
 020-620-01



9 mm

11,0 cm, 4 3/8"
 020-620-02



9 mm

11,0 cm, 4 3/8"
 020-620-03



9 mm

11,0 cm, 4 3/8"
 020-620-04

diamantbeschichtet
 diamond coated
 diamantado
 diamantato

Atraumatische Pinzetten
 Atraumatic Forceps
 Pinzas atraumáticas
 Pinze anatomiche atraumatica



1,5 mm 2,0 mm 2,4 mm 2,8 mm



16,0 cm, 6¹/₄" **020-700-16** **020-702-16** **020-704-16** **020-706-16**
 20,0 cm, 8" **020-700-20** **020-702-20** **020-704-20** **020-706-20**
 24,0 cm, 9¹/₂" **020-700-24** **020-702-24** **020-704-24** **020-706-24**
 30,0 cm, 12" **020-700-30** **020-702-30** **020-704-30** **020-706-30**

2,8 mm 3,5 mm 3,5 mm



16,0 cm, 6¹/₄" **020-716-16** **020-708-16** **020-718-16**
 20,0 cm, 8" **020-716-20** **020-708-20** **020-718-20**
 24,0 cm, 9¹/₂" **020-716-24** **020-708-24** **020-718-24**
 30,0 cm, 12" **020-716-30** **020-708-30** **020-718-30**

DE BAKEY



1,5 mm 2,0 mm



16,0 cm, 6¹/₄" **020-701-16** **020-703-16**
 20,0 cm, 8" **020-701-20** **020-703-20**
 24,0 cm, 9¹/₂" **020-701-24** **020-703-24**
 30,0 cm, 12" **020-701-30** **020-703-30**

DE BAKEY

Pinzetten mit Hartmetalleinlagen
 Forceps with tungsten carbide inserts
 Pinzas con bocas de carburo tungsteno
 Pinze con morsi in carburo di tungsteno



STANDARD

14,5 cm, 5 ³ / ₄ "	021-200-14
16,0 cm, 6 ¹ / ₄ "	021-200-16
18,0 cm, 7"	021-200-18
20,0 cm, 8"	021-200-20
25,0 cm, 10"	021-200-25
30,0 cm, 12"	021-200-30



STANDARD

14,0 cm, 5 ¹ / ₂ "	021-208-14
16,0 cm, 6 ¹ / ₄ "	021-208-16
18,0 cm, 7"	021-208-18
20,0 cm, 8"	021-208-20
25,0 cm, 10"	021-208-25
30,0 cm, 12"	021-208-30



STANDARD

12,5 cm, 5"	021-040-12
15,0 cm, 6"	021-040-15



STANDARD

15,0 cm, 6"	021-140-15
23,0 cm, 9"	021-140-23
25,0 cm, 10"	021-140-25

Pinzetten mit Hartmetalleinlagen
 Forceps with tungsten carbide inserts
 Pinzas con bocas de carburo tungsteno
 Pinze con morsi in carburo di tungsteno



GILLIES
 15,0 cm, 6"
 021-300-15



MC INDOE
 15,0 cm, 6"
 021-158-15



GERALD
 17,0 cm, 6³/₄"

021-102-17



021-302-17



POTTS-SMITH
 15,0 cm, 6" **021-026-15**
 18,0 cm, 7" **021-026-18**
 20,0 cm, 8" **021-026-20**



BONNEY
 17,5 cm, 6⁵/₈"
 021-590-17



CUSHING
 17,5 cm, 6⁵/₈"



021-092-17



021-093-17



CUSHING-TAYLOER
 18,0 cm, 7"
 021-117-18



ADSON
 17,5 cm, 6⁵/₈"

12,0 cm, 4³/₄"
021-070-12

12,0 cm, 4³/₄"
021-270-12

15,0 cm, 6"
021-070-15

15,0 cm, 6"
021-270-15



Tuch-, Schlauchklemmen, Tupferzangen

Towel Clamps, Sponge and Dressing Forceps, Tubing Clamps

Pinzas de campo, Pinzas para vendajes y torundas y para tubos

Pinze per fissare le compresse, per medicatura e tamponi, e per tubi



Made in Pakistan

Tuchklemmen
Towel Clamps
Pinzas de campo
Pinze per fissare le compresse



SCHAEDEL
9,0 cm, 3 1/2"
030-101-09



ENGL. MODELL
9,0 cm, 3 1/2"
030-109-09



JONES
5,0 cm, 2"
030-105-05



JONES
9,0 cm, 3 1/2"
030-107-09

mit Schlauch- oder Kabelhalter
with clip for tubing or cable
con porta-tubo o porta-cable
con porta-tubo o porta-cavo



BACKHAUS
9,0 cm, 3 1/2" **030-000-09**
11,0 cm, 4 3/8" **030-000-11**
13,0 cm, 5" **030-000-13**
15,0 cm, 6" **030-000-15**



11,0 cm, 4 3/8"
030-005-11



ROEDER
13,0 cm, 5"
030-010-13

Tuchklemmen
Towel Clamps
Pinzas de campo
Pinze per fissare le compresse



ROEDER
15,0 cm, 5"
030-010-15



BERNHARD
16,5 cm, 6 1/2"
030-044-16



Kugel / Pfanne
Ball / Socket
Bola / Cojinete
Palla / Cuscinetto

13,0 cm, 5"
030-024-13

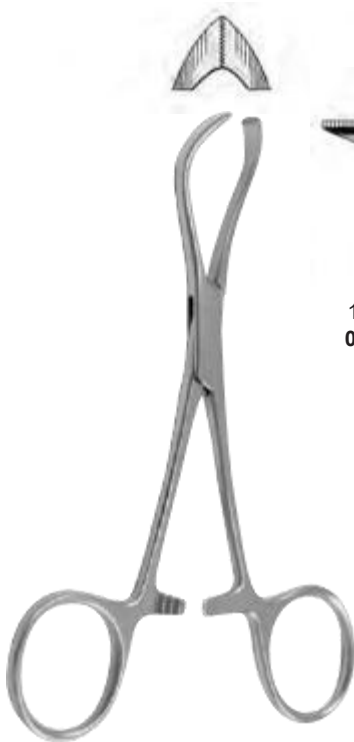

LORNA



10,0 cm, 4" **030-014-10** 13,0 cm, 5" **030-014-13**



LANE
15,0 cm, 6" **030-040-15**
18,0 cm, 7" **030-040-18**
20,0 cm, 8" **030-040-20**

Tuchklemmen, Korn- und Tupferzangen
 Towel Clamps, Sponge and Dressing Forceps
 Pinzas de campo, Pinzas para vendajes y torundas
 Pinze per fissare le compresse, Pinze per medicatura e tamponi



TOHOKU

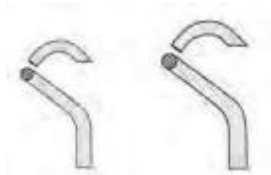

10,0 cm, 4" **030-020-10** 13,0 cm, 5" **030-020-13**



PEERS

14,5 cm, 5³/₄" **030-030-14**



LISTER

13,0 cm, 5" **030-360-13**
 16,0 cm, 6¹/₄" **030-360-16**
 18,0 cm, 7" **030-360-18**



BRYANT

13,0 cm, 5" **030-351-13**



BOZEMANN

26,0 cm, 10¹/₄" **030-320-26**

Korn- und Tupferzangen
Sponge and Dressing Forceps
Pinzas para vendajes y torundas
Pinze per medicatura e tamponi



BOZEMANN
 26,0 cm, 10¹/₄"
 030-321-26



COLLIN
 25,0 cm, 9³/₄"
 030-300-25



CHERON
 25,0 cm, 9³/₄"
 030-303-25

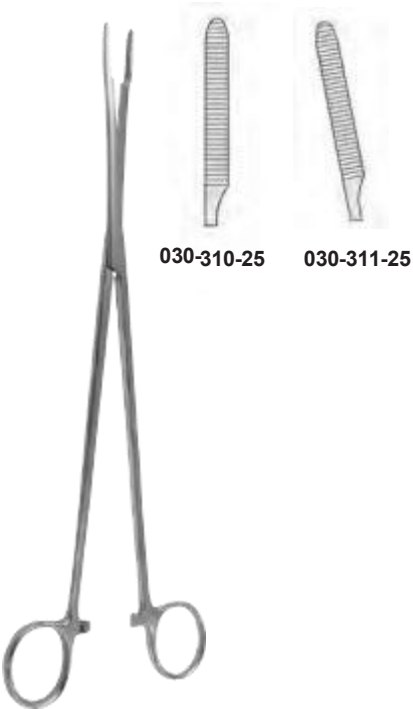

PELKMAN
 25,0 cm, 9³/₄"

030-310-25 030-311-25



ULRICH

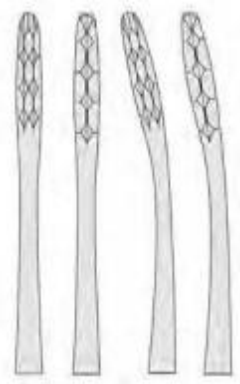

22,0 cm, 8⁵/₈" 030-200-22 030-201-22
 25,0 cm, 9³/₄" 030-200-25 030-201-25
 27,0 cm, 10⁵/₈" 030-200-27 030-201-27

Korn- und Tupferzangen
Sponge and Dressing Forceps
Pinzas para vendajes y torundas
Pinze per medicatura e tamponi

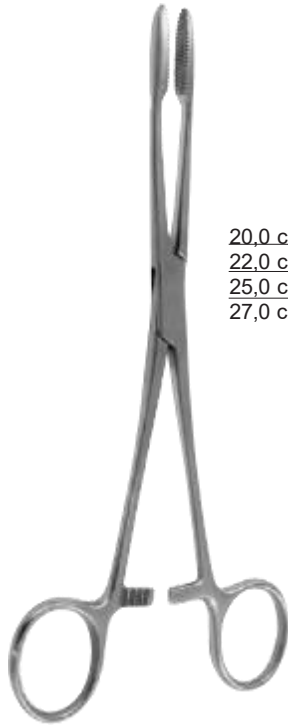

GROSS-MAIER



20,0 cm, 8"	030-210-20	030-211-20
22,0 cm, 8 ⁵ / ₈ "	030-210-22	030-211-22
25,0 cm, 9 ³ / ₄ "	030-210-25	030-211-25
27,0 cm, 10 ⁵ / ₈ "	030-210-27	030-211-27



FOERSTER



25,0 cm, 9³/₄"
030-180-25

25,0 cm, 9³/₄"
030-181-25



FOERSTER-BALLENGER



18,0 cm, 7"	030-160-18	030-161-18	030-170-18	030-171-18
20,0 cm, 8"	030-160-20	030-161-20	030-170-20	030-171-20
25,0 cm, 9 ³ / ₄ "	030-160-25	030-161-25	030-170-25	030-171-25

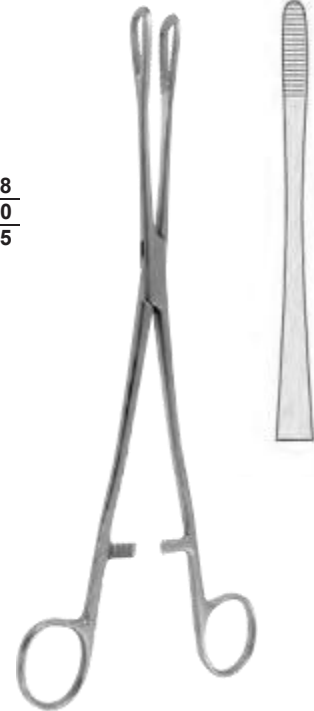

RAMPLEY

18,0 cm, 7"	030-190-18
25,0 cm, 9 ³ / ₄ "	030-190-25



PRESBYTERIAN
16,5 cm, 6 1/2" 032-012-16
18,0 cm, 7" 032-012-18
 20,0 cm, 8" 032-012-20



BERLIN
 14,5 cm, 5 3/4"
 032-006-14



15,0 cm, 6" 032-002-15
 18,0 cm, 7" 032-002-18
 20,0 cm, 8" 032-002-20



15,0 cm, 6" 032-004-15
 18,0 cm, 7" 032-004-18
 20,0 cm, 8" 032-004-20



Klemmen

Forceps

Pinas

Pinze



Made in Pakistan

**Bulldogklemmen
Bulldog Clamps
Clamps Bulldog
Pinze Bulldog**



3,5 cm, 1 1/2"	026-014-03	026-015-03
5,0 cm, 2"	026-014-05	026-015-05



DIEFFENBACH



HESS
026-520-01



HESS
026-520-02



3,8 cm, 1 1/2"	026-018-04	026-019-04
5,0 cm, 2"	026-018-05	026-019-05
6,3 cm, 2 1/2"	026-018-06	026-019-06
7,6 cm, 3"	026-018-07	026-019-07
9,0 cm, 3 1/2"	026-018-09	026-019-09

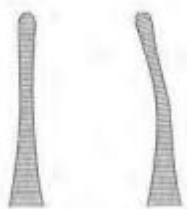

JOHNS-HOPKINS



JOHNS-HOPKINS
23,0 cm, 9"
026-295-23



mittraumatischer Riefung
 with non-traumatic serration
 con bocasatraumáticas
 con presa atraumatica
 с атравматичной зазубренностью

		L	
7,5 cm, 3"	026-292-07	2,5 cm, 1"	
8,5 cm, 3 1/4"	026-292-08	3,5 cm, 1 3/8"	
10,5 cm, 4 1/8"	026-292-10	5,0 cm, 2"	
12,0 cm, 4 3/4"	026-292-12	6,8 cm, 2 3/4"	

DE BAKEY



mittraumatischer Riefung
 with non-traumatic serration
 con bocasatraumáticas
 con presa atraumatica
 с атравматичной зазубренностью

		L	
7,0 cm, 2 3/4"	026-293-07	2,5 cm, 1"	
8,0 cm, 3 1/8"	026-293-08	3,5 cm, 1 3/8"	
10,0 cm, 3 3/4"	026-293-10	5,0 cm, 2"	
11,5 cm, 4 1/2"	026-293-12	6,8 cm, 2 3/4"	

DE BAKEY



TITANIUM
 3,5 cm, 1 3/8"
 vena **027-032-35**
 arteria **027-042-35**



TITANIUM
 3,5 cm, 1 3/8"
 vena **027-033-35**
 arteria **027-043-35**



gerade
 straight
 recto
 retto

TITANIUM
 4,0 cm, 1 5/8"
 vena **027-032-40**
 arteria **027-042-40**



gebogen
 curved
 curvo
 curvo

TITANIUM
 4,0 cm, 1 5/8"
 vena **027-033-40**
 arteria **027-043-40**

Bulldogklemmen, Darm- und Gewebefaßzangen
Bulldog Clamps, Intestinal and Tissue Grasping Forceps
Clamps Bulldog, Pinzas intestinales y para tejidos
Pinze Bulldog, Pinze da presa per intestino e tessuti

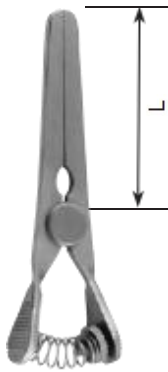

		L	
6,8 cm, 2 3/4"	026-298-07	3,3 cm, 1 3/8"	
9,6 cm, 3 3/4"	026-298-09	5,0 cm, 2"	
11,7 cm, 4 3/4"	026-298-11	6,9 cm, 2 3/4"	

GLOVER

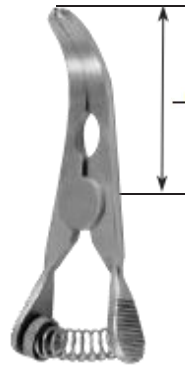

		L	
6,5 cm, 2 1/2"	026-299-06	3,3 cm, 1 3/8"	
9,1 cm, 3 1/2"	026-299-09	5,0 cm, 2"	
11,0 cm, 4 3/8"	026-299-11	6,9 cm, 2 3/4"	

GLOVER



CHAPUT
 13,0 cm, 5"
040-370-13



TUFFIER
 13,0 cm, 5"
040-372-13



COLLIN
 16,0 cm, 6 1/4"
040-376-16

Darm- und Gewebefazangen
 Intestinal and Tissue Grasping Forceps
 Pinzas intestinales y para tejidos
 Pinze da presa per intestino e tessuti



PENNINGTON
 15,5 cm, 6" **040-358-15**
 20,0 cm, 8" **040-358-20**



ATRAUMA

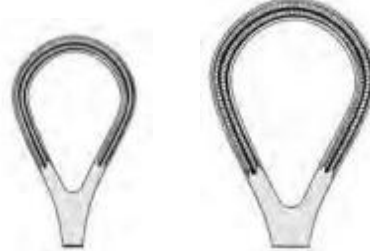

25,0 cm, 9³/₄"
040-658-25

27,0 cm, 10¹/₂"
040-658-27



MARTEL
 14,0 cm, 5¹/₂"
040-364-14



WILLET-MARTEL
 19,0 cm, 7¹/₂"
040-366-19

Arterienklemmen
 Haemostatic Forceps
 Pinzas hemostáticas
 Pinze emostatiche



PRATT
 15,0 cm, 6"
 040-656-15



FERGUSSON

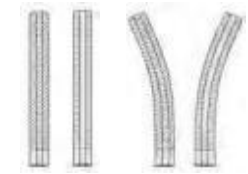

16,0 cm, 6 ¹ / ₄ "	040-650-16	040-651-16
20,0 cm, 8"	040-650-20	040-651-20



CARREL
 10,0 cm, 4"
 040-010-10



TERRIER
 10,0 cm, 4"
 040-016-10



KROENLEIN
 13,0 cm, 5"
 040-369-13



PEAN
14,0 cm, 5½" **040-368-14**
16,0 cm, 6¼" **040-368-16**



BABY-MIXTER
14,0 cm, 5½"

040-475-01

040-475-02



SPENCER-WELLS

13,0 cm, 5"	040-290-13	040-291-13
15,0 cm, 6"	040-290-15	040-291-15
18,0 cm, 7"	040-290-18	040-291-18
20,0 cm, 8"	040-290-20	040-291-20



HARTMANN
10,0 cm, 4"

040-000-10

040-001-10

Arterienklemmen
 Haemostatic Forceps
 Pinzas hemostáticas
 Pinze emostatiche



040-140-14

040-141-14

PROVICENCE-HOSPITAL
 14,0 cm, 5½"



HALSTED-MOSQUITO

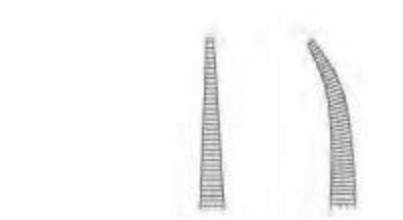

12,5 cm, 5" 040-050-12 040-051-12
 14,0 cm, 9¾" 040-050-14 040-051-14

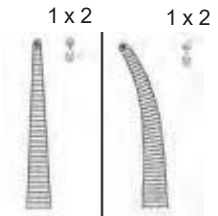

12,5 cm, 5" 040-070-12 040-071-12
 14,0 cm, 9¾" 040-070-14 040-071-14



HALSTED-MOSQUITO

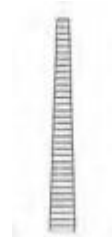

18,0 cm, 7"
 040-050-18



18,0 cm, 7"
 040-051-18

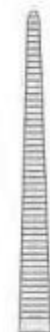

21,0 cm, 8¼"
 040-050-21



21,0 cm, 8¼"
 040-051-21

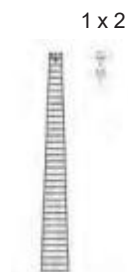

18,0 cm, 7"
 040-070-18



18,0 cm, 7"
 040-071-18

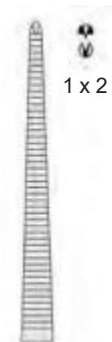

21,0 cm, 8¼"
 040-070-21



21,0 cm, 8¼"
 040-071-21

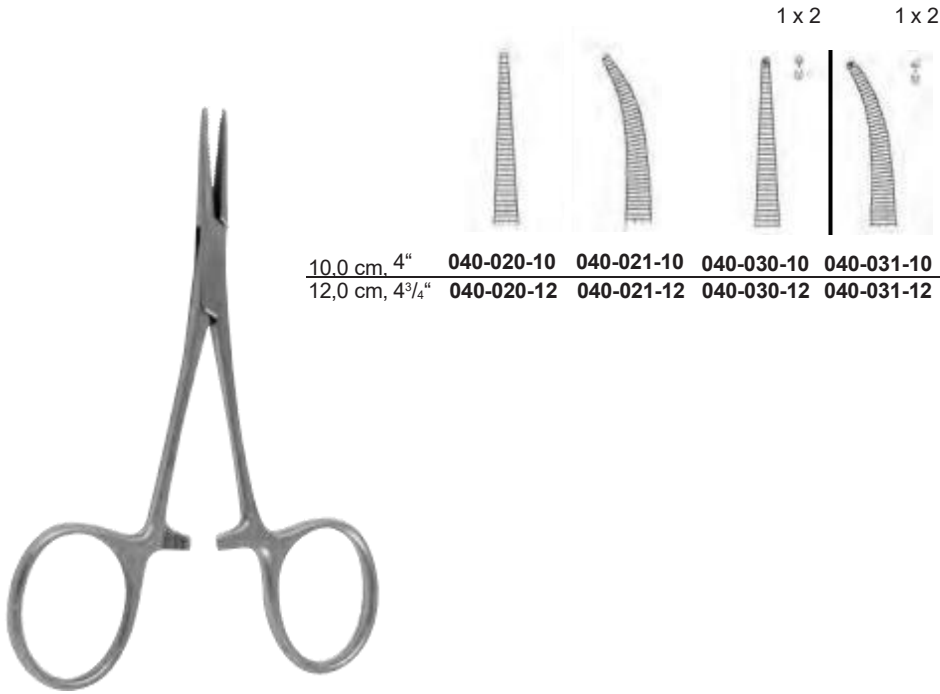

10,0 cm, 4"	040-020-10	040-021-10	040-030-10	040-031-10
12,0 cm, 4 3/4"	040-020-12	040-021-12	040-030-12	040-031-12

MICRO-MOSQUITO



040-150-14 040-151-14

KELLY
 14,0 cm, 5 1/2"



040-152-16 040-153-16

KELLY-RANKIN
 16,0 cm, 6 1/4"

Arterienklemmen
 Haemostatic Forceps
 Pinzas hemostáticas
 Pinze emostatiche



LERICHE
 15,0 cm, 6"

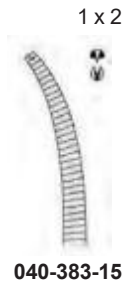
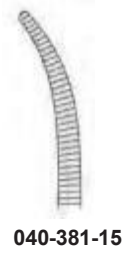
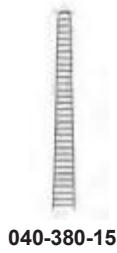

BABY-OVERHOLT
 13,5 cm, 5¼"
 040-424-14



DANDY
 14,0 cm, 5½"

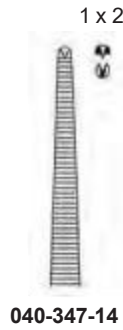

CRILE
 14,0 cm, 5½"

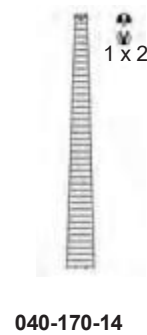
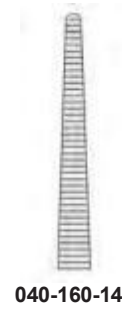

Arterienklemmen
 Haemostatic Forceps
 Pinzas hemostáticas
 Pinze emostatiche

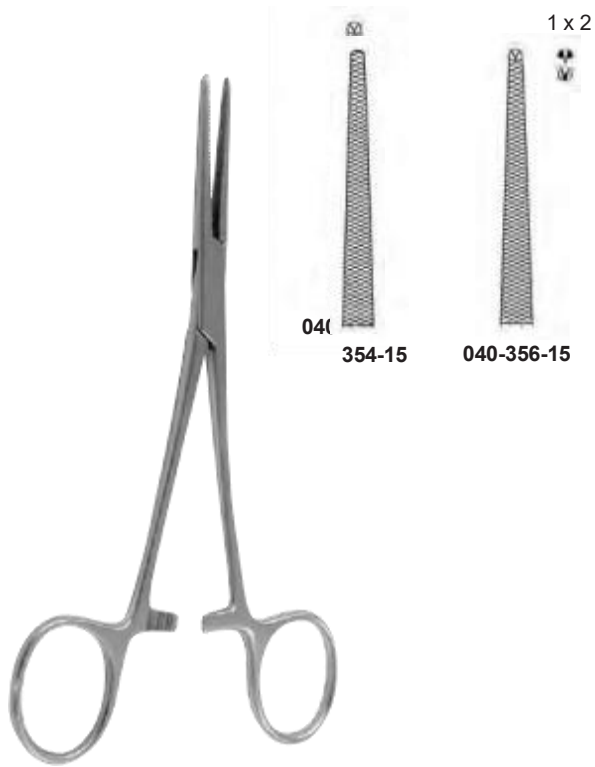

DIXON-LOVELACE
 15,0 cm, 6"

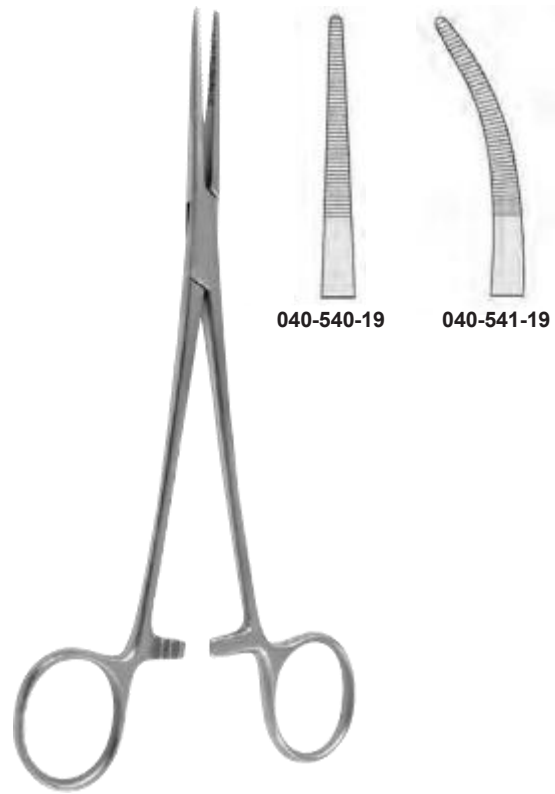

BIRKETT
 19,0 cm, 7 1/2"

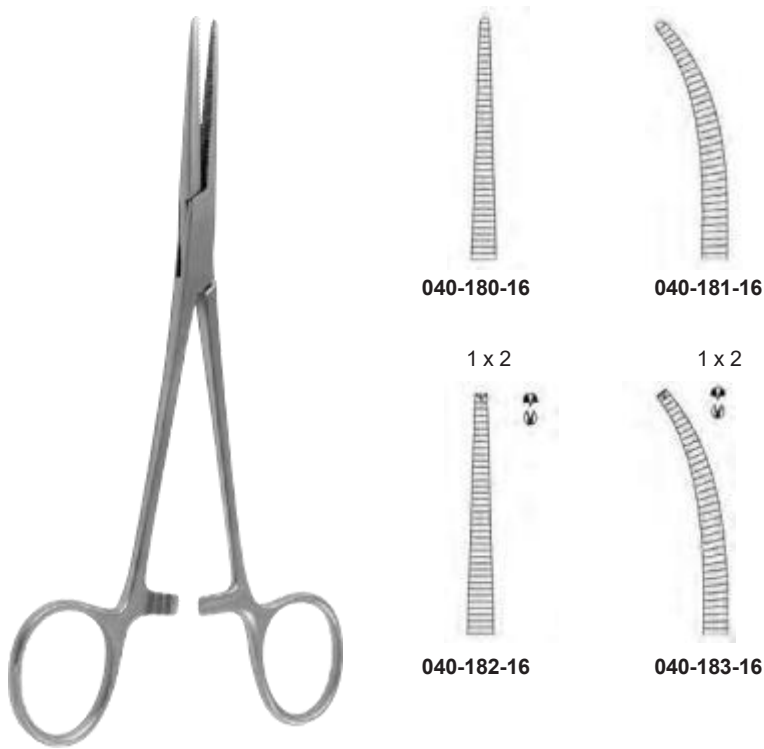

CRILE-RANKIN
 16,0 cm, 6 1/4"

Arterienklemmen
 Haemostatic Forceps
 Pinzas hemostáticas
 Pinze emostatiche



SCHNIDT
 19,0 cm, 7 1/2"



132-187-19



132-185-19



SCHNIDT-SAWTELL
 19,0 cm, 7 1/2"



132-183-19



132-181-19



ADSON
 18,5 cm, 7 1/4"



040-414-16



040-415-18



040-412-18



040-413-18



CRAFOORD
 24,0 cm, 9 1/2"
 040-453-24

Arterienklemmen
Haemostatic Forceps
Pinzas hemostáticas
Pinze emostatiche



15,0 cm, 6"	040-480-15	040-481-15
18,5 cm, 7 1/4"	040-480-18	040-481-18

BAINBRIDGE



16,0 cm, 6 1/4"	040-340-16	040-341-16
20,0 cm, 8"	040-340-20	040-341-20

ROCHESTER-CARMALT



13,0 cm, 5"	040-262-13	040-263-13
14,0 cm, 5 1/2"	040-262-14	040-263-14
16,0 cm, 6 1/4"	040-262-16	040-263-16

PEAN DELICATE



13,0 cm, 5"	040-352-13	040-353-13
14,0 cm, 5 1/2"	040-352-14	040-353-14
16,0 cm, 6 1/4"	040-352-16	040-353-16

KOCHER DELICATE

Arterienklemmen
 Haemostatic Forceps
 Pinzas hemostáticas
 Pinze emostatiche



ROCHESTER-PEAN

14,0 cm, 5½"	040-260-14	040-261-14
16,0 cm, 6¼"	040-260-16	040-261-16
18,0 cm, 7"	040-260-18	040-261-18
20,0 cm, 8"	040-260-20	040-261-20
22,0 cm, 8⅝"	040-260-22	040-261-22
24,0 cm, 9½"	040-260-24	040-261-24
26,0 cm, 10¼"	040-260-26	040-261-26
30,0 cm, 12"	040-260-30	040-261-30

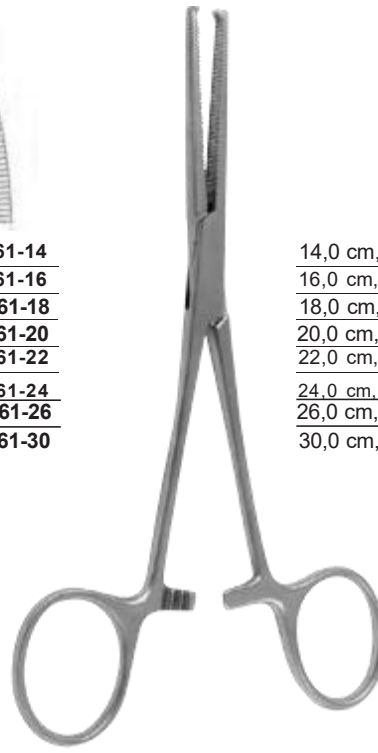
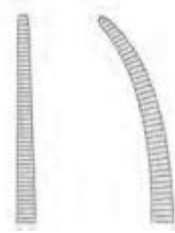

KOCHER-OCHSNER

14,0 cm, 5½"	040-350-14	040-351-14
16,0 cm, 6¼"	040-350-16	040-351-16
18,0 cm, 7"	040-350-18	040-351-18
20,0 cm, 8"	040-350-20	040-351-20
22,0 cm, 8⅝"	040-350-22	040-351-22
24,0 cm, 9½"	040-350-24	040-351-24
26,0 cm, 10¼"	040-350-26	040-351-26
30,0 cm, 12"	040-350-30	040-351-30

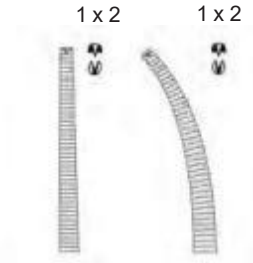

BENGOLEA

20,0 cm, 8"	040-384-20	040-385-20	040-386-20	040-387-20
26,0 cm, 10¼"	040-384-26	040-385-26	040-386-26	040-387-26

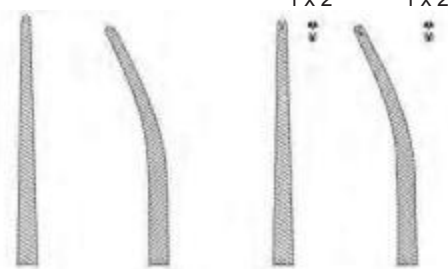

Arterienklemmen
 Haemostatic Forceps
 Pinzas hemostáticas
 Pinze emostatiche

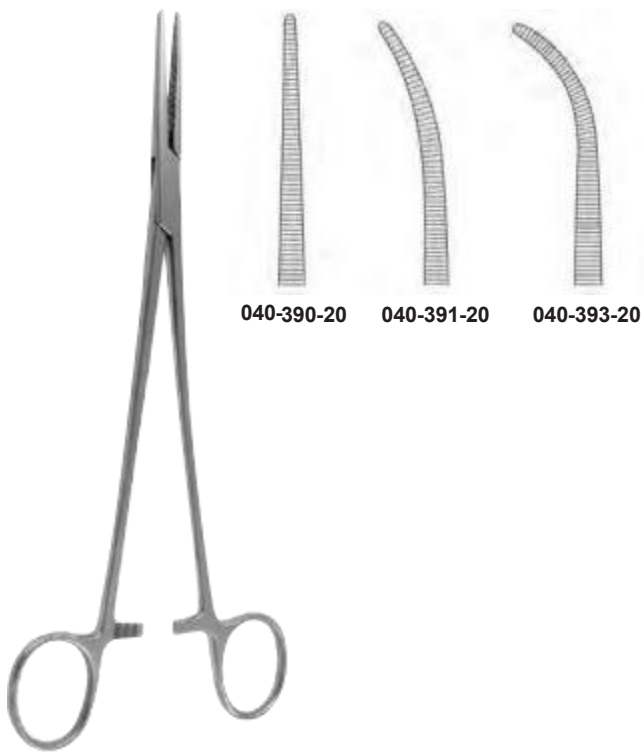

040-390-20 040-391-20 040-393-20

HEISS
 20,0 cm, 8"



040-448-22 040-449-22

ROBERTS
 22,0 cm, 8⁵/₈"



040-450-24 040-451-24

SAROT
 24,0 cm, 9¹/₂"



040-533-01 040-533-02

NEGUS
 19,0 cm, 7¹/₂"

Präparier- und Ligaturklemmen
Dissecting and Ligature Forceps
Pinzas de disección y ligaduras
Pinze per preparazioni e legature



14,0 cm, 5½"
040-411-14

18,0 cm, 7"
040-411-18

BABY-ADSON



MICRO-ADSON
 14,0 cm, 5½"
040-409-14



BABY-MIXTER
 18,0 cm, 7"
040-475-18



OVERHOLT-MIXTER
 21,0 cm, 8¼"
040-471-21



JOHNS HOPKINS
 20,0 cm, 8"
040-497-20

Präparier- und Ligaturklemmen
Dissecting and Ligature Forceps
Pinzas de disección y ligaduras
Pinze per preparazioni e legature



OVERHOLT

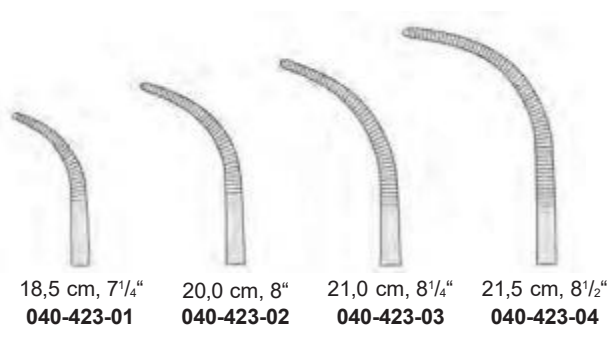

RUMEL
 23,0 cm, 9"

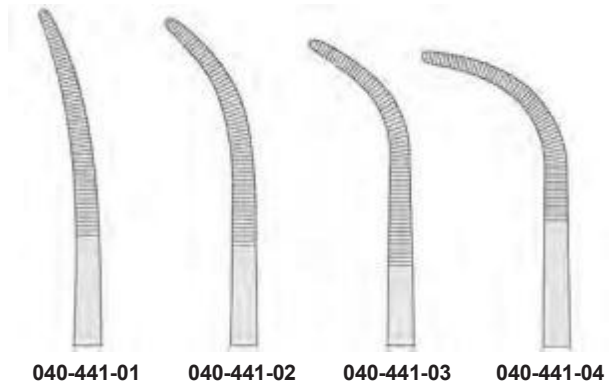

Präparier- und Ligaturklemmen
Dissecting and Ligature Forceps
Pinzas de disección y ligaduras
Pinze per preparazioni e legature

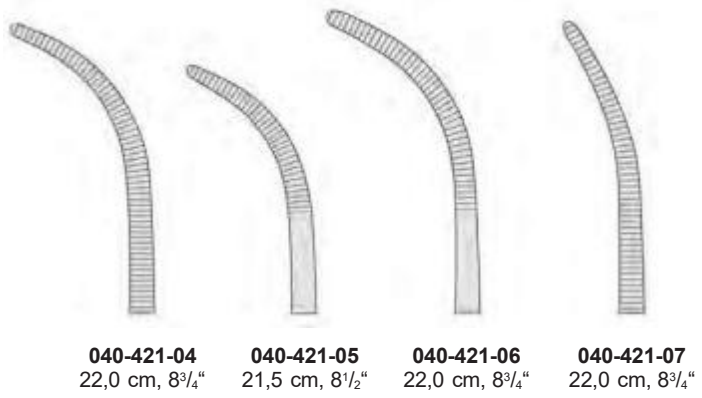
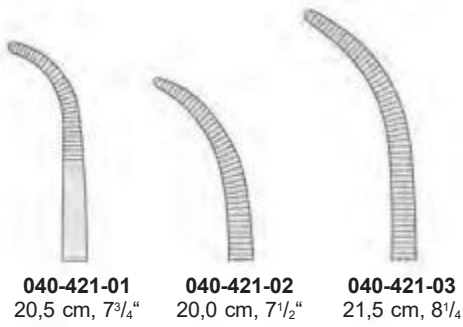

OVERHOLT-GEISSENDOERFER

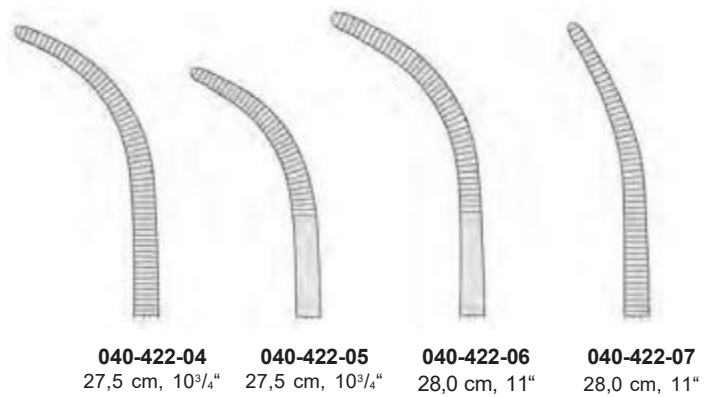
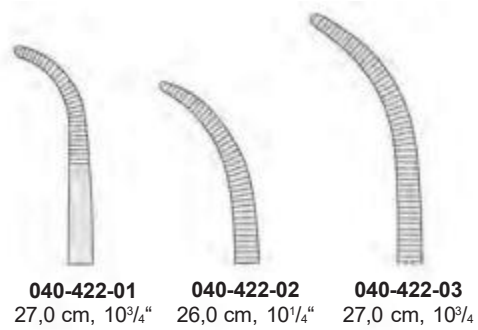



TOENNIS

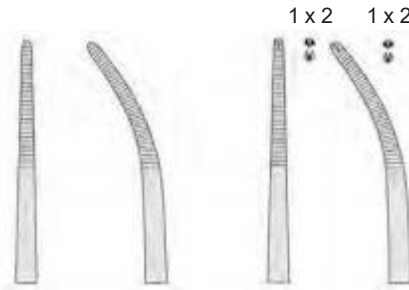

21,0 cm, 8¹/₄" **040-442-21** **040-443-21** **040-444-21** **040-445-21**
 26,0 cm, 10¹/₄" **040-442-26** **040-443-26** **040-444-26** **040-445-26**



KELLY

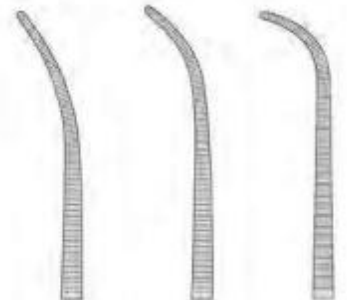

19,0 cm, 7¹/₂" **040-463-19** **040-465-19** **040-467-19**
 22,0 cm, 8⁵/₈" **040-463-22** **040-465-22** **040-467-22**
 24,0 cm, 9¹/₂" **040-463-24** **040-465-24** **040-467-24**

Präparier- und Ligaturklemmen
Dissecting and Ligature Forceps
Pinzas de disección y ligaduras
Pinze per preparazioni e legature



18,0 cm, 7"	040-429-18
22,0 cm, 8 ⁵ / ₈ "	040-429-22
25,0 cm, 9 ³ / ₄ "	040-429-25
28,0 cm, 11"	040-429-28

MINI-GEMINI



14,0 cm, 5 ¹ / ₂ "	040-431-14
16,0 cm, 6 ¹ / ₄ "	040-431-16
18,0 cm, 7"	040-431-18
20,0 cm, 8"	040-431-20
23,0 cm, 9"	040-431-23
25,0 cm, 9 ³ / ₄ "	040-431-25
28,0 cm, 11"	040-431-28

GEMINI

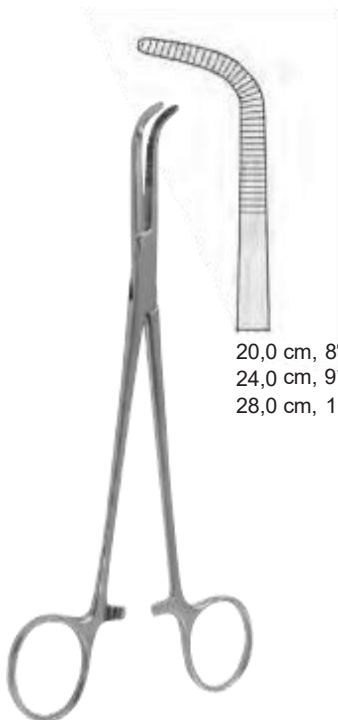

20,0 cm, 8"	040-433-20
24,0 cm, 9 ¹ / ₂ "	040-433-24
28,0 cm, 11"	040-433-28

KANTROWITZ



19,0 cm, 7 ¹ / ₂ "	040-543-19
21,0 cm, 8 ¹ / ₄ "	040-543-21
24,0 cm, 9 ¹ / ₂ "	040-543-24

WIKSTROEM



Made in Pakistan

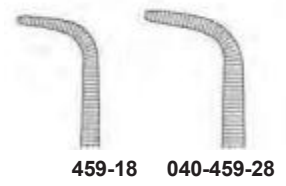
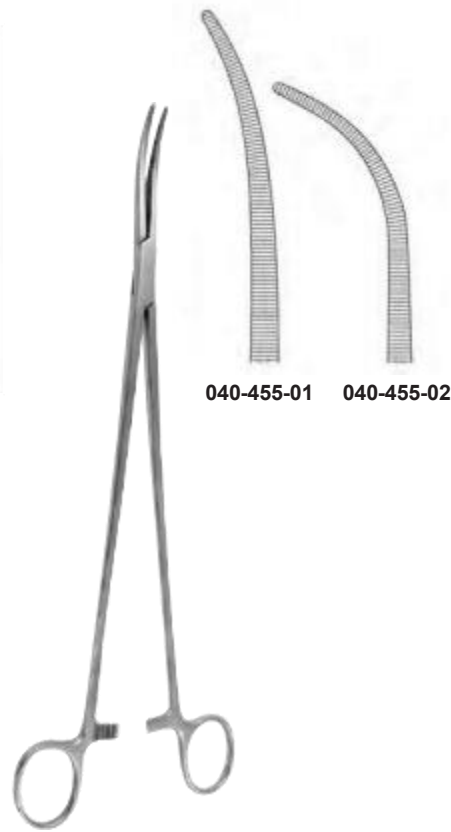



MIXTER
 15,5 cm, 6" **040-461-15**
 19,0 cm, 7½" **040-461-19**



MIXTER-O'SHAUGNESSY
 15,5 cm, 6" **040-477-15**
 19,0 cm, 7½" **040-477-19**



MIXTER
 22,0 cm, 8¾" **040-473-22**



040-

MIXTER
 23,0 cm, 9" **040-473-23**

ZENKER

ZENKER

Präparier- und Ligaturklemmen
Dissecting and Ligature Forceps
Pinzas de disección y ligaduras
Pinze per preparazioni e legature



LAWRENCE
27,5 cm, 10³/₄"
040-457-28



HOSEMANN
21,0 cm, 8¹/₄"



DESJARDINS
21,0 cm, 8¹/₄"
040-529-21





MIXTER
22,0 cm, 8³/₄" **040-479-22**
25,0 cm, 9³/₄" **040-479-25**
28,0 cm, 11" **040-479-28**



LAHEY
19,0 cm, 7¹/₂" **040-501-19**
23,0 cm, 9" **040-501-23**



LOWER
18,0 cm, 7"
040-503-18

Made in Pakistan

Präparier- und Ligaturklemmen
 Dissecting and Ligature Forceps
 Pinzas de disección y ligaduras
 Pinze per preparazioni e legature



MC QUIGG-MIXTER
 22,0 cm, 8³/₄"
 040-507-22

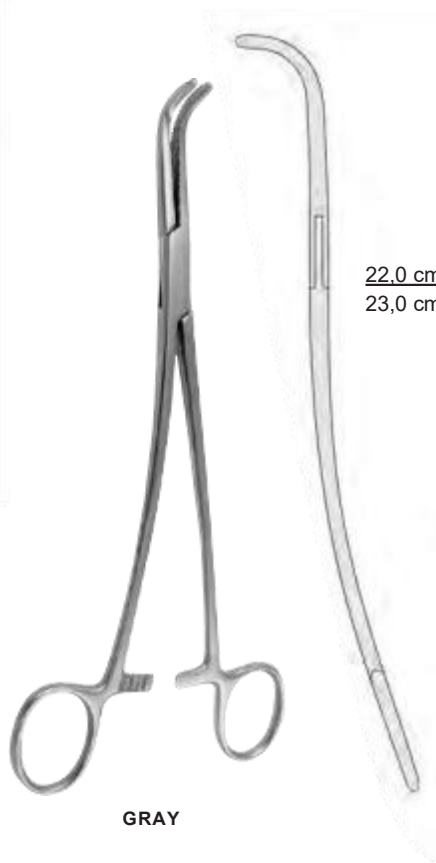

GRAY

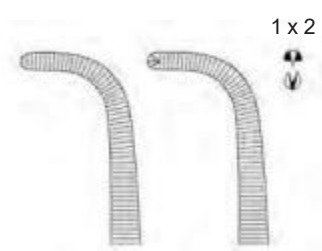

22,0 cm, 8³/₄" 040-523-22 040-525-22
 23,0 cm, 9" 040-523-23 040-525-23



CRAFOORD-SELLORS

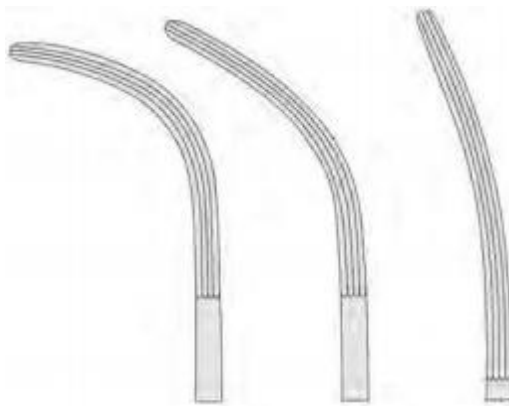

22,0 cm, 8³/₄" 040-456-22
 23,0 cm, 9" 040-456-23
 24,0 cm, 9¹/₂" 040-456-24



FINOCCHIETTO
 24,0 cm, 9¹/₂"
 040-505-24

Gallenkanal- und Nierenstielklemmen
 Gall Duct and Kidney Pedicle Clamps
 Pinzas-clamps para pedúnculo renal
 Pinze per peduncoli renali



GUYON

20,0 cm, 8" **040-509-20**
 22,0 cm, 8³/₄" **040-509-22**
 24,0 cm, 9¹/₂" **040-509-24**

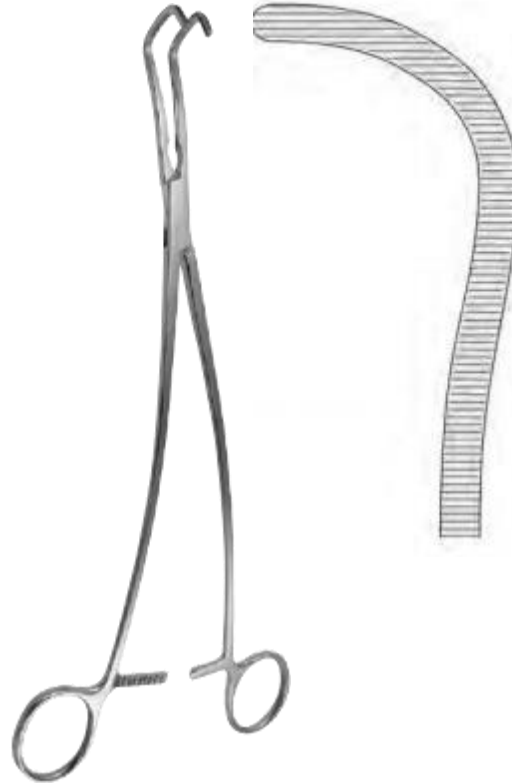

GUYON

23,0 cm, 9"
040-513-23

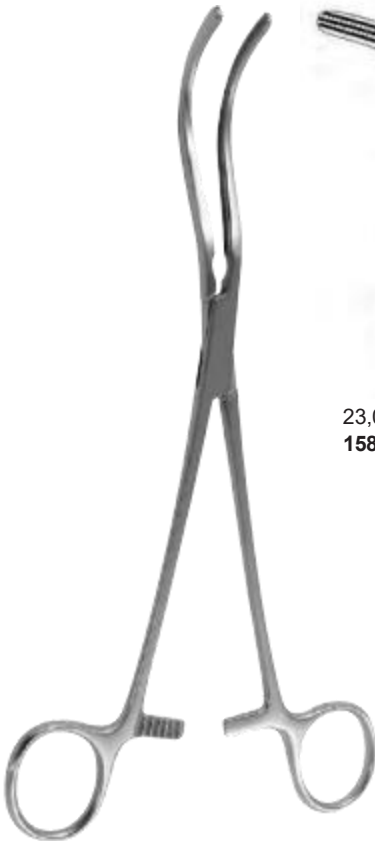

GUYON

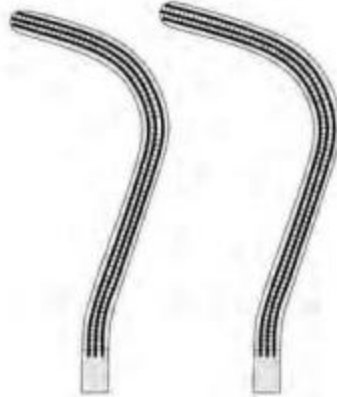

23,0 cm, 9"
158-519-23

24,0 cm, 9¹/₂"
158-519-24



STILLE

23,0 cm, 9"
040-511-23

Gallenkanal- und Nierenstielklemmen, Bronchusklemmen
 Gall Duct and Kidney Pedicle Clamps, Bronchus Forceps
 Pinzas-clamps para pedúnculo renal, Pinzas-clamps para bronquios
 Pinze per peduncoli renali, Pinze per legature



HERRICK
 23,0 cm, 9"
 040-517-23



URO-TANGENTIAL



23,0 cm, 9"
 170-055-01

24,0 cm, 9½"
 170-055-02



LOVELACE
 20,0 cm, 8"
 141-004-20



LOVELACE
 20,0 cm, 8"
 141-005-20



PRICE-THOMAS
 22,0 cm, 8¾"
 141-001-22

Bronchusklemmen, Peritoneumklemmen, Hysterektomieklemmen
Bronchus Forceps, Peritoneum Forceps, Hysterectomy Forceps
Pinzas-clamps para bronquios, Pinzas-clamps para peritoneo y para histerectomía
Pinze per legature, Pinze per peritoneo e per isterectomia



PRICE-THOMAS
 22,0 cm, 8³/₄"



141-002-01



141-002-02



SEMB
 24,0 cm, 9¹/₂"

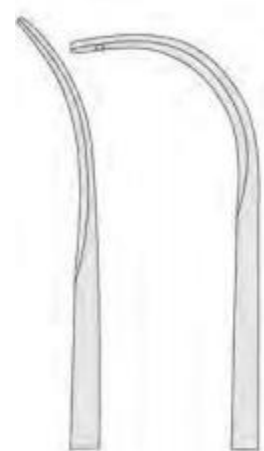

141-003-01

141-003-02



BABY-MIKULICZ
 14,0 cm, 5¹/₂"
 040-701-14

1 x 2



MIKULICZ
 18,0 cm, 7"
 040-703-18

1 x 2



MIKULICZ
 20,0 cm, 8"
 040-709-20

1 x 2



Peritoneumklemmen, Hysterektomieklemmen
 Peritoneum Forceps, Hysterectomy Forceps
 Pinzas-clamps para peritoneo y para histerectomía
 Pinze per peritoneo e per isterectomia

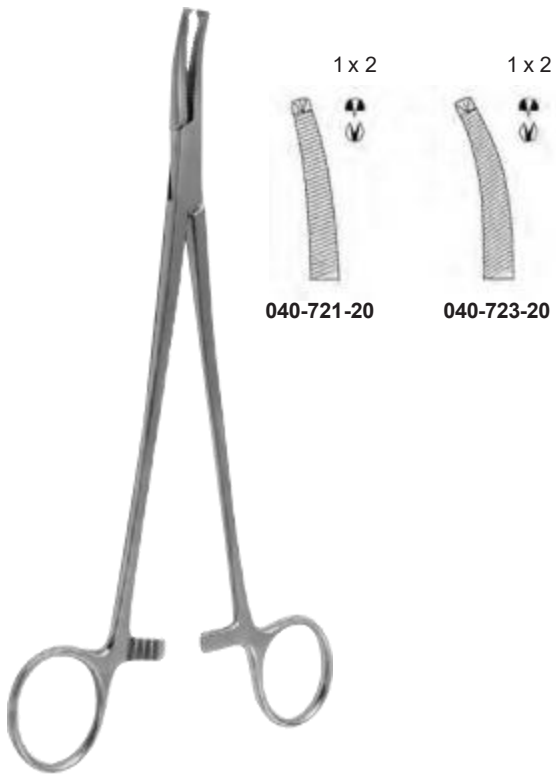

040-721-20

040-723-20

FAURE
 20,0 cm, 8"

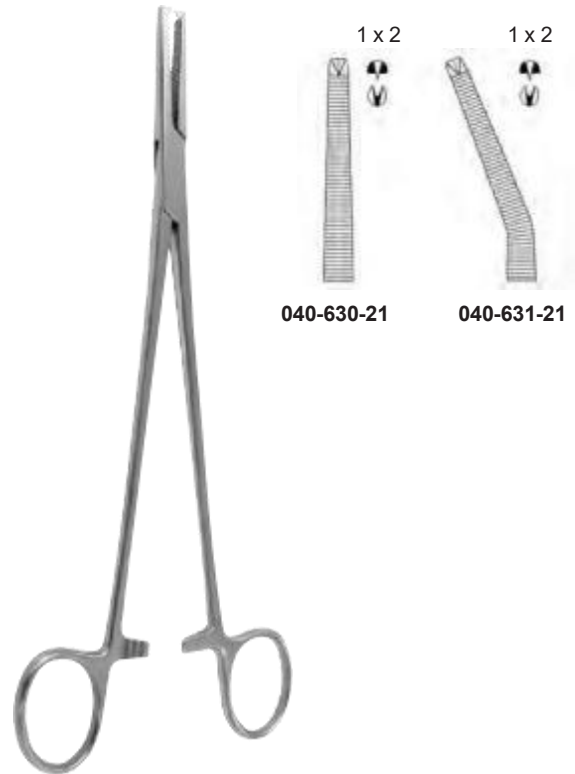

040-630-21

040-631-21

PHANEUF
 21,5 cm, 8½"



WERTHEIM
 24,0 cm, 9½"
 040-601-24



WERTHEIM
 25,0 cm, 10"
 040-602-25

Hysterektomieklemmen
 Hysterectomy Forceps
 Pinzas-clamps para histerectomía
 Pinze per isterectomia



WERTHEIM
 23,0 cm, 9"

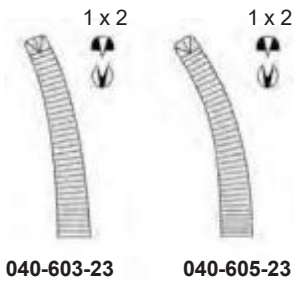

MAINGOT
 21,5 cm, 8½"

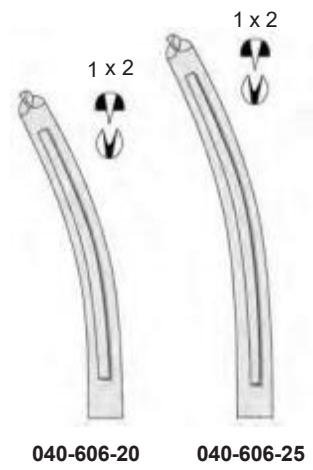

MOYNIHAN

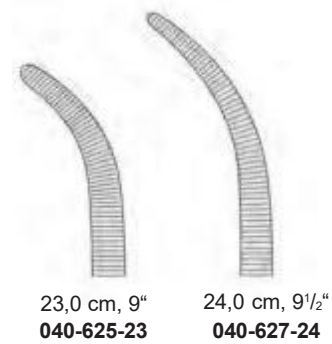

WERTHEIM-CULLEN
 21,5 cm, 8½"
 040-629-21

Hysterektomieklemmen
 Hysterectomy Forceps
 Pinzas-clamps para histerectomía
 Pinze per isterectomia

1 x 2



LONG
 19,0 cm, 7 1/4"

040-621-19



GARLAND
 21,0 cm, 8 1/4"

040-623-21



HEANEY
 21,0 cm, 8 1/4"

040-607-21



HEANEY-BALLANTINE
 21,0 cm, 8 1/4"

040-614-21

040-615-21



HEANEY-KANTER
 21,0 cm, 8 1/4"

040-617-21

Hysterektomieklemmen
Hysterectomy Forceps
Pinzas-clamps para histerectomía
Pinze per isterectomia



21,0 cm, 8 ¹ / ₄ "	040-611-21	040-613-21
23,0 cm, 9"	040-611-23	040-613-23

HEANEY



Nahtinstrumente
Suture Instruments
Instrumentos para sutura
Strumenti per sutura

Nadelhalter
Needle Holders
Porta-agujas
Portaghi



DERF



050-010-12
12,0 cm, 4³/₄"



050-020-12
12,5 cm, 5"



COLLIER
12,5 cm, 5"
050-022-12



WEBSTER
13,0 cm, 5"
050-028-13



HALSEY
13,0 cm, 5"

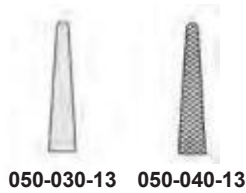

050-030-13 **050-040-13**



NEIVERT
13,0 cm, 5"
050-046-13



HEGAR-BAUMGARTNER
14,0 cm, 5¹/₂"
050-048-14

Nadelhalter
Needle Holders
Porta-agujas

Portaghi



050-096-13
13,0 cm, 5"

BROWN



CRILE-MURRAY
15,0 cm, 6"
050-070-15



050-060-15
15,0 cm, 6"

CRILE-WOOD



ADSON
18,0 cm, 7"
050-192-18



METZENBAUM
18,0 cm, 7"
050-190-18



MASS.-GENERAL-HOSPITAL
17,0 cm, 6³/₄"
050-072-17

Nadelhalter
Needle Holders
Porta-agujas
Portaghi



MAYO-HEGAR

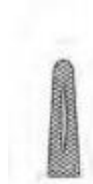

050-080-14
14,0 cm, 5½"



050-080-16
16,0 cm, 6¼"



050-080-18
18,0 cm, 7"



050-080-20
20,0 cm, 8"



050-080-24
24,0 cm, 9½"



050-080-26
26,0 cm, 10¼"



050-080-30
30,0 cm, 12"



MAYO-HEGAR-DELICATE



050-090-16
16,0 cm, 6¼"



050-090-18
18,0 cm, 7"



050-090-20
20,0 cm, 8"



LAWRENCE
15,0 cm, 6"
050-110-15



Nadelhalter
Needle Holders
Porta-agujas
Portaghi



HEANEY
21,0 cm, 8¼"
050-141-21



JAMISON
23,5 cm, 9¼"
050-148-23



MASSON
27,0 cm, 10½"
050-150-27



FINOCCHIETTO
27,0 cm, 10½"
050-211-27



WANGENSTEEN
27,0 cm, 10½"
050-160-27



JOHNSON
27,0 cm, 10½"
050-193-27

Nadelhalter
Needle Holders
Porta-agujas
Portaghi



STRATTE
23,0 cm, 9"
050-230-23



OLSEN-HEGAR
17,0 cm, 6³/₄"
050-310-17

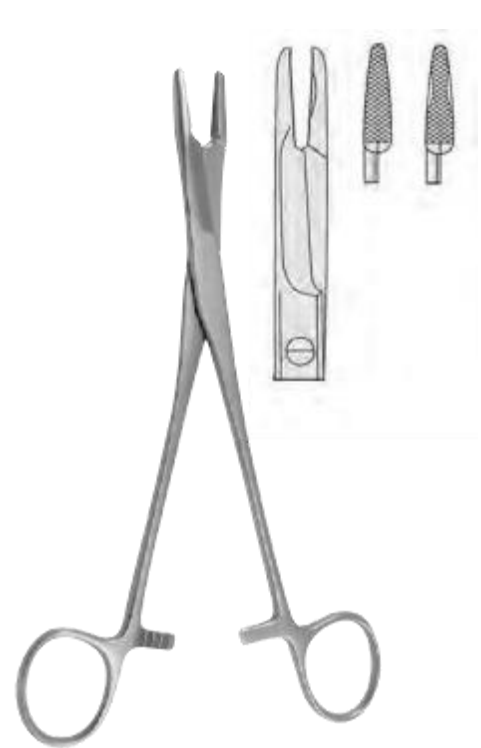

OLSEN-HEGAR
14,0 cm, 5¹/₂"
050-306-14



OLSEN-HEGAR

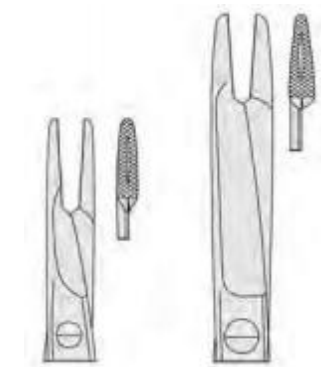

14,0 cm, 5¹/₂"
050-310-14

18,0 cm, 7"
050-310-18



TOENNIS
18,0 cm, 7"
050-362-18

**Nadelhalter
Needle Holders
Porta-agujas
Portaghi**



050-350-14
14,0 cm, 5½"



050-350-17
17,0 cm, 6¾"



050-350-20
20,0 cm, 8"



050-356-17
17,0 cm, 6¾"



050-356-20
20,0 cm, 8"

MATHIEU

MATHIEU



LICHTENBERG
20,0 cm, 8"
050-366-20



050-354-14
14,0 cm, 5½"



050-354-17
17,0 cm, 6¾"

MATHIEU

Nadelhalter, Mikro-Nadelhalter
Needle Holders, Micro Needle Holders
Porta-agujas, Micro Porta-agujas
Portaghi, Micro Portaghi



050-358-14
 14,0 cm, 5½"



050-358-17
 17,0 cm, 6¾"



050-358-20
 20,0 cm, 8"



MATHIEU-KOCHER



050-550-10



050-551-10



BARRAQUER-TROUTMAN
 10,0 cm, 4"



050-553-10



050-553-13



BARRAQUER



BARRAQUER
 13,5 cm, 5⅓"
050-621-13



GOMEL
 14,0 cm, 5½"
050-601-14

Mikro-Nadelhalter
Micro Needle Holders
Micro Porta-agujas
Micro Portaghi



050-600-18

050-601-18

ohne Sperre
 without ratchet
 sin cremallera
 senza cremagliera

18,5 cm, 7¼"



050-630-18

050-631-18

mitSperre
 with ratchet
 con cremallera
 con cremagliera

18,5 cm, 7¼"



050-570-14

050-571-14

050-576-14

050-577-14

mitSperre
 with ratchet
 con cremallera
 con cremagliera

CASTROVIEJO
 14,5 cm, 5¾"



050-570-18

050-571-18

050-576-18

050-577-18

mitSperre
 with ratchet
 con cremallera
 con cremagliera

CASTROVIEJO
 18,0 cm, 7"

Mikro-Nadelhalter
Micro Needle Holders
Micro Porta-agujas
Micro Portaghi

gerade, ohne Sperre
 straight, without ratchet
 recta, sin cremallera
 retta, senza cremagliera

0,4 mm



14,0 cm, 5 1/2"
050-650-14

gebogen, ohne Sperre
 curved, without ratchet
 curva, sin cremallera
 curva, senza cremagliera

0,4 mm



14,0 cm, 5 1/2"
050-651-14

gebogen, mit Sperre
 curved, with ratchet
 curva, con cremallera
 curva, con cremagliera

0,4 mm



14,0 cm, 5 1/2"
050-653-14

gebogen, ohne Sperre
 curved, without ratchet
 curva, sin cremallera
 curva, senza cremagliera

0,5 mm



14,0 cm, 5 1/2"
050-661-14

gebogen, mit Sperre
 curved, with ratchet
 curva, con cremallera
 curva, con cremagliera

0,5 mm



Ø 10 mm

14,0 cm, 5 1/2"
050-663-14

gebogen, ohne Sperre
 curved, without ratchet
 curva, sin cremallera
 curva, senza cremagliera

0,4 mm



Ø 8 mm

13,0 cm, 5"
050-671-13

Nadelhalter mit Hartmetalleinlagen
 Needle Holders with tungsten carbide inserts
 Porta-agujas con bocas de carburo tungsteno
 Portaghi con morsi in carburo di tungsteno



KALT
 13,5 cm, 5³/₈"
 051-428-14



DIETRICH

- 16,0 cm, 5³/₈" **051-250-16**
- 18,0 cm, 7" **051-250-18**
- 20,0 cm, 8" **051-250-20**
- 23,0 cm, 9" **051-250-23**
- 26,0 cm, 10¹/₄" **051-250-26**



WEBSTER
 13,0 cm, 5"
 051-028-13



DERF
 12,0 cm, 4³/₄"
 051-010-12



HEGAR-BAUMGARTNER

051-048-12
 12,5 cm, 5"

051-048-14
 14,0 cm, 5¹/₂"



WEBSTER
 13,0 cm, 5"
 051-029-13

Nadelhalter mit Hartmetalleinlagen
Needle Holders with tungsten carbide inserts
Porta-agujas con bocas de carburo tungsteno
Portaghi con morsi in carburo di tungsteno



051-030-13

HALSEY
13,0 cm, 5"



051-040-13

CRILE-WOOD



051-060-15
15,0 cm, 6"

051-060-18
18,0 cm, 7"



SAROT

051-224-18
18,0 cm, 7"

051-224-20
20,0 cm, 8"

051-224-26
26,0 cm, 10¹/₄"

Nadelhalter mit Hartmetalleinlagen
 Needle Holders with tungsten carbide inserts
 Porta-agujas con bocas de carburo tungsteno
 Portaghi con morsi in carburo di tungsteno



MAYO-HEGAR



051-080-16
16,0 cm, 6¹/₄"



051-080-18
18,0 cm, 7"



051-080-20
20,0 cm, 8"



051-080-24
24,0 cm, 9¹/₂"



051-080-26
26,0 cm, 10¹/₄"



051-080-30
30,0 cm, 12"



MAYO-HEGAR (HEANEY)



051-141-20
20,0 cm, 8"



051-141-24
24,0 cm, 9¹/₄"



051-141-26
26,0 cm, 10¹/₄"

Nadelhalter mit Hartmetalleinlagen
Needle Holders with tungsten carbide inserts
Porta-agujas con bocas de carburo tungsteno
Portaghi con morsi in carburo di tungsteno



DE BAKEY



051-114-18
18,0 cm, 7"



051-114-20
20,0 cm, 8"



051-114-23
23,0 cm, 9"



051-114-26
26,0 cm, 10¹/₄"



051-114-31
31,0 cm, 12¹/₄"



051-114-37
37,0 cm, 14¹/₂"



RYDER-VASCULAR



051-132-13
13,0 cm, 5"



051-132-15
15,0 cm, 6"



051-132-18
18,0 cm, 7"



051-132-20
20,0 cm, 8"



051-132-23
23,0 cm, 9"



051-132-26
26,0 cm, 10¹/₄"

Nadelhalter mit Hartmetalleinlagen
Needle Holders with tungsten carbide inserts
Porta-agujas con bocas de carburo tungsteno
Portaghi con morsi in carburo di tungsteno



RYDER

051-134-13
13,0 cm, 5"

051-134-15
15,0 cm, 6"

051-134-18
18,0 cm, 7"

051-134-20
20,0 cm, 8"

051-134-23
23,0 cm, 9"

051-134-26
26,0 cm, 10 1/4"



SCHWEDISCHES MODELL

051-136-15
15,0 cm, 6"



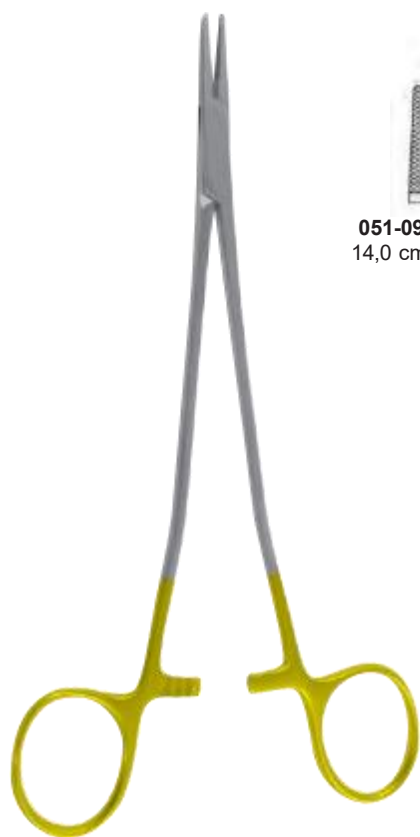

051-136-17
17,0 cm, 6 3/4"

051-136-20
20,0 cm, 8"

Nadelhalter mit Hartmetalleinlagen
 Needle Holders with tungsten carbide inserts
 Porta-agujas con bocas de carburo tungsteno
 Portaghi con morsi in carburo di tungsteno



MAYO-HEGAR (HEANEY)

- 
051-090-14
 14,0 cm, 5½"
- 
051-090-18
 18,0 cm, 7"
- 
051-090-20
 20,0 cm, 8"
- 
051-090-23
 23,0 cm, 9"



FINOCCHIETTO
 27,0 cm, 10½"
 051-211-27



MASSON
 27,0 cm, 10½"
 051-150-27



WANGENSTEEN
 27,0 cm, 10½"
 051-160-27

Nadelhalter mit Hartmetalleinlagen
 Needle Holders with tungsten carbide inserts
 Porta-agujas con bocas de carburo tungsteno
 Portaghi con morsi in carburo di tungsteno



BOZEMANN

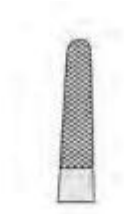

051-185-20
20,0 cm, 8"

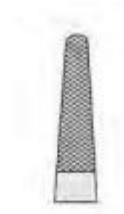

051-185-24
24,0 cm, 9⁵/₈"

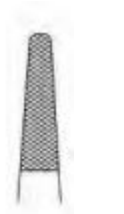

051-185-26
26,0 cm, 10¹/₄"



HEGAR



051-084-20
20,0 cm, 8"

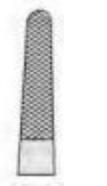

051-084-24
24,0 cm, 9⁵/₈"



BARRY STERNAL



051-240-15
15,0 cm, 6"



051-242-20
20,0 cm, 8"

Nadelhalter mit Hartmetalleinlagen
 Needle Holders with tungsten carbide inserts
 Porta-agujas con bocas de carburo tungsteno
 Portaghi con morsi in carburo di tungsteno



STRATTE



051-230-22
 22,0 cm, 8⁵/₈"



051-230-23
 23,0 cm, 9"



GILLIES
 16,0 cm, 6¹/₄"
051-330-16

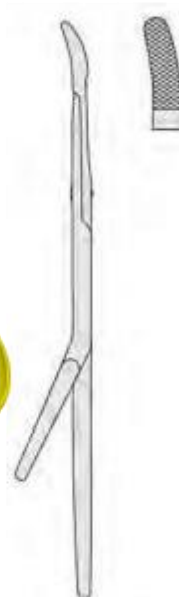

OLSEN-HEGAR



051-310-14
 14,0 cm, 5¹/₂"



051-310-17
 17,0 cm, 6³/₄"



051-310-18
 18,0 cm, 7"



TOENNIS
 18,0 cm, 7"
051-362-18

Nadelhalter mit Hartmetalleinlagen
Needle Holders with tungsten carbide inserts
Porta-agujas con bocas de carburo tungsteno
Portaghi con morsi in carburo di tungsteno



MATHIEU-KOCHER



051-358-14
14,0 cm, 5½"



051-358-17
17,0 cm, 6¾"

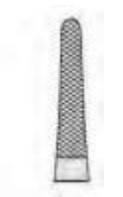

051-358-20
20,0 cm, 8"



MATHIEU

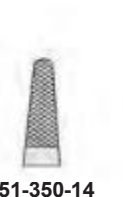

051-350-14
14,0 cm, 5½"

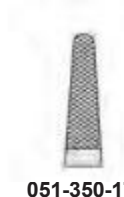

051-350-17
17,0 cm, 6¾"



051-350-20
20,0 cm, 8"

Nadelhalter mit Hartmetalleinlagen
Needle Holders with tungsten carbide inserts
Porta-agujas con bocas de carburo tungsteno
Portaghi con morsi in carburo di tungsteno



LICHTENBERG



051-366-17
17,0 cm, 6³/₄"



051-366-20
20,0 cm, 8"



MATHIEU



051-356-17
17,0 cm, 6³/₄"



051-356-20
20,0 cm, 8"



051-356-23
23,0 cm, 9"

Nadelhalter mit Hartmetalleinlagen
Needle Holders with tungsten carbide inserts
Porta-agujas con bocas de carburo tungsteno
Portaghi con morsi in carburo di tungsteno

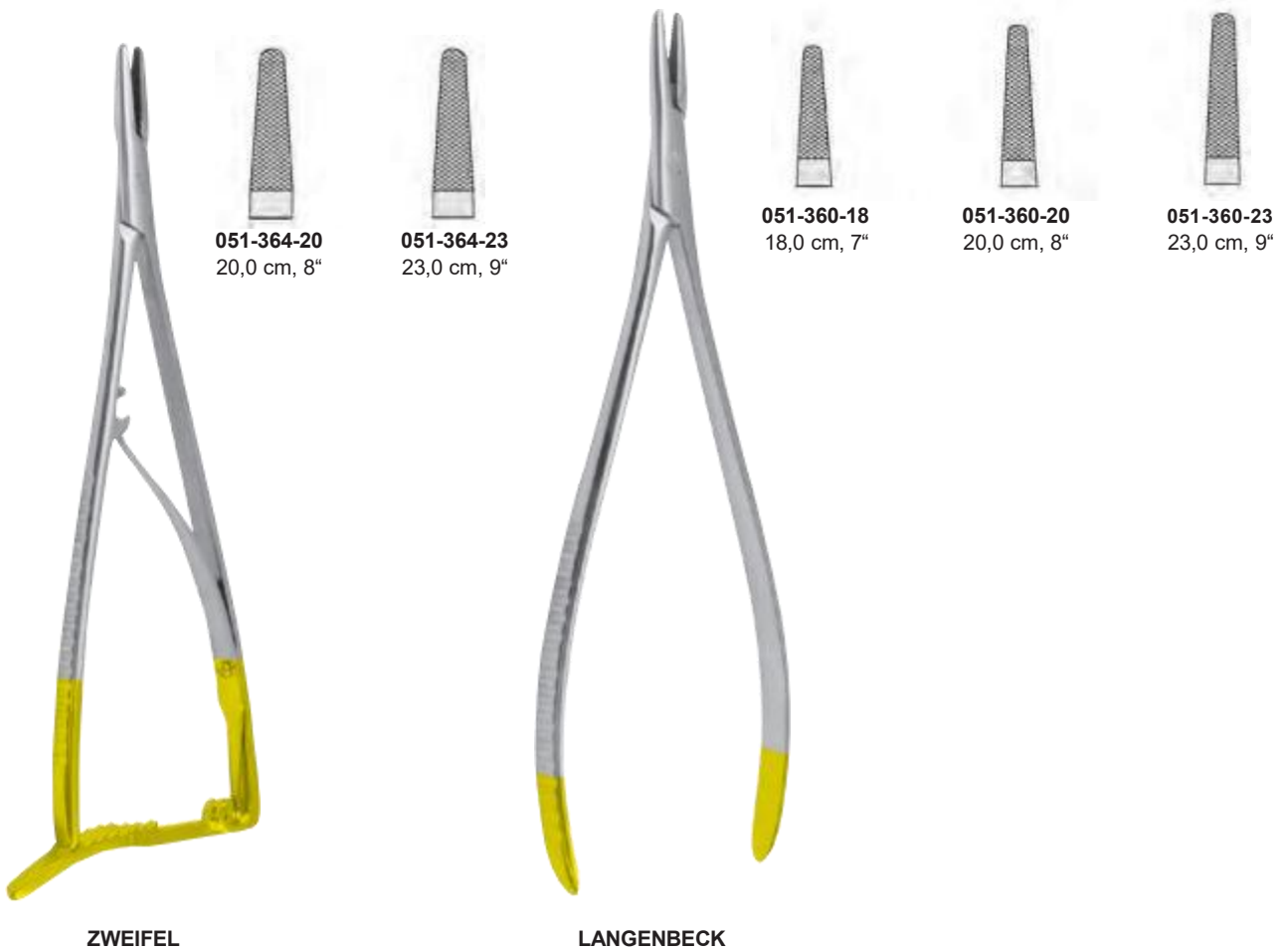

Nadelhalter mit Hartmetalleinlagen
 Needle Holders with tungsten carbide inserts
 Porta-agujas con bocas de carburo tungsteno
 Portaghi con morsi in carburo di tungsteno



mit Sperre
 with ratchet
 con cremallera
 con cremagliera

CASTROVIEJO
 14,5 cm, 5³/₄"

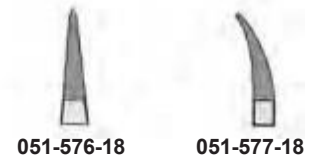

mit Sperre
 with ratchet
 con cremallera
 con cremagliera

CASTROVIEJO
 18,0 cm, 7"

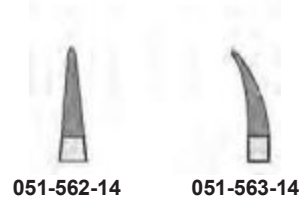
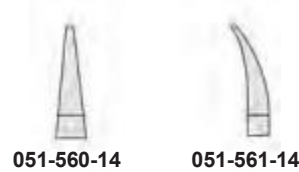

mit Sperre
 with ratchet
 con cremallera
 con cremagliera

BARRAQUER
 14,5 cm, 5³/₄"



HEPP SCHEIDEL
 18,0 cm, 7"
 051-390-18



REVERDIN
 14,0 cm, 5½"

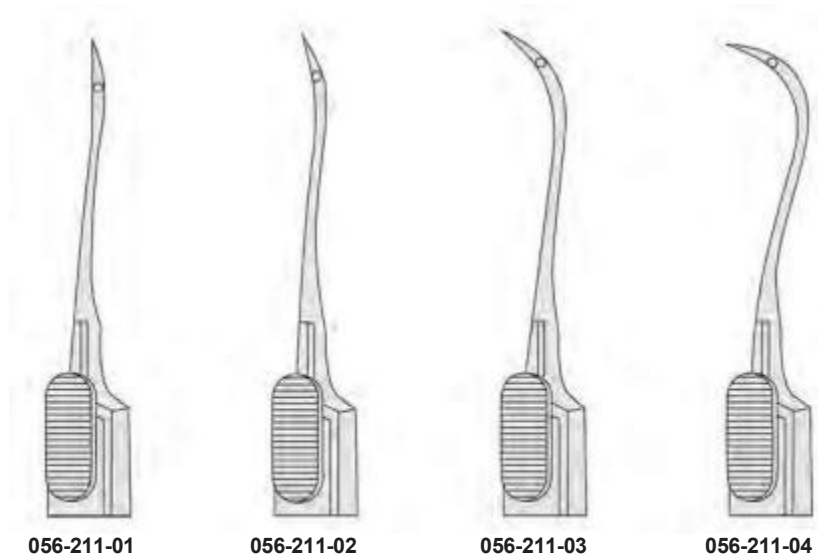

056-211-01

056-211-02

056-211-03

056-211-04



REVERDIN



19,5 cm, 7¾" 056-221-01 056-221-02 056-221-03 056-221-04
 22,5 cm, 8¾" 056-223-01 056-223-02 056-223-03 056-223-04

Unterbindungsnadeln
 Ligature Needles
 Agujas para ligaduras
 Aghi per legatura

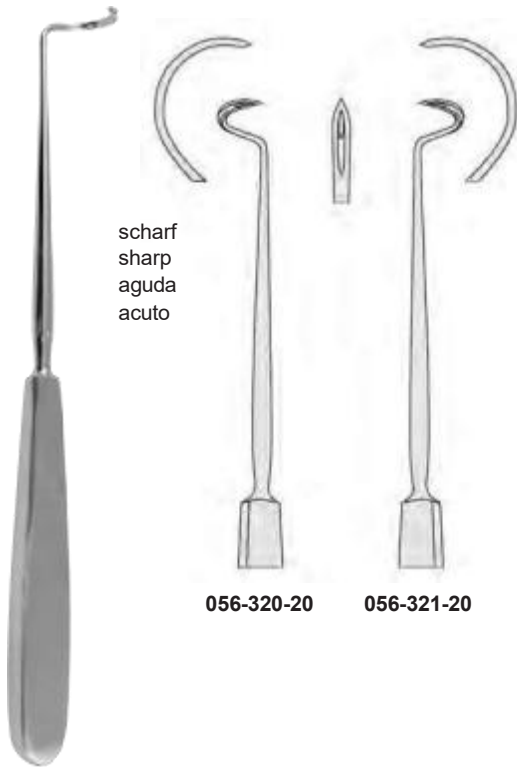

scharf
 sharp
 aguda
 acuto

056-320-20

056-321-20

DESCHAMPS
 20,0 cm, 8"

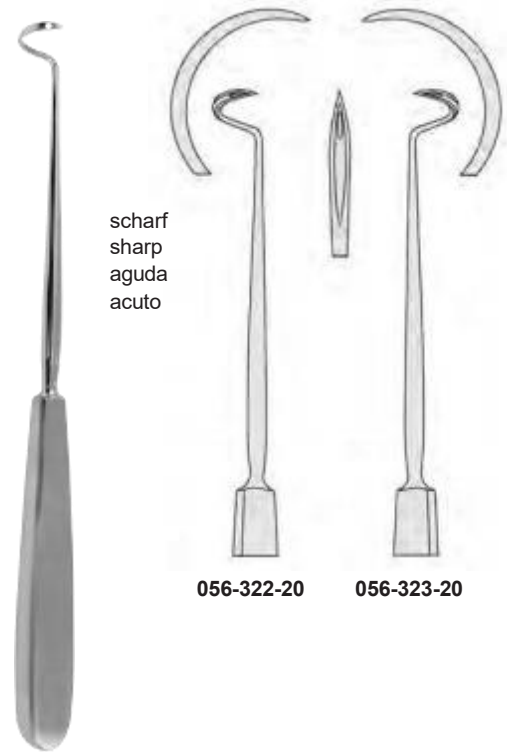

scharf
 sharp
 aguda
 acuto

056-322-20

056-323-20

DESCHAMPS
 20,0 cm, 8"

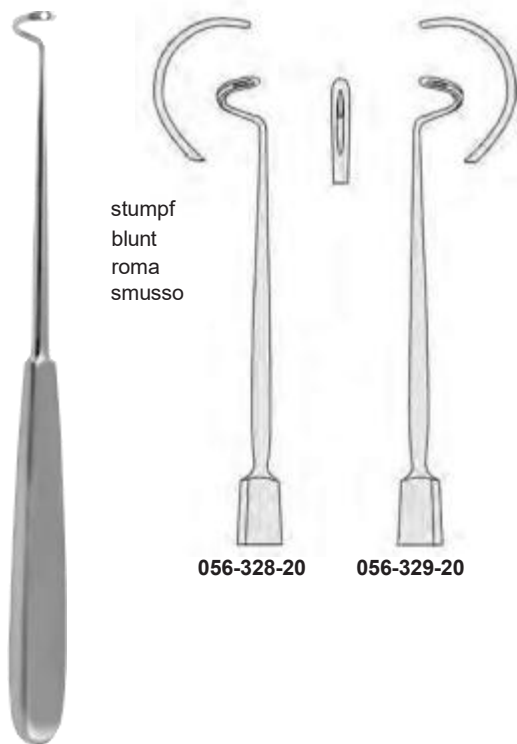

stumpf
 blunt
 roma
 smusso

056-328-20

056-329-20

DESCHAMPS
 20,0 cm, 8"

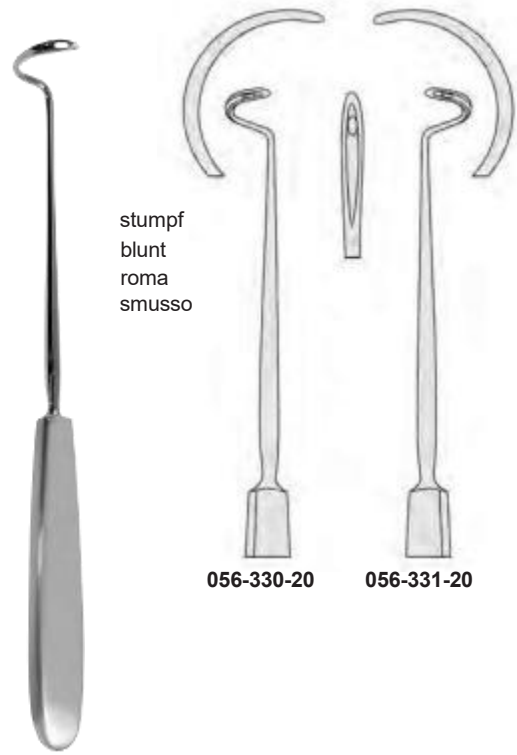

stumpf
 blunt
 roma
 smusso

056-330-20

056-331-20

DESCHAMPS
 20,0 cm, 8"

Unterbindungsnadeln
 Ligature Needles
 Agujas para ligaduras
 Aghi per legatura

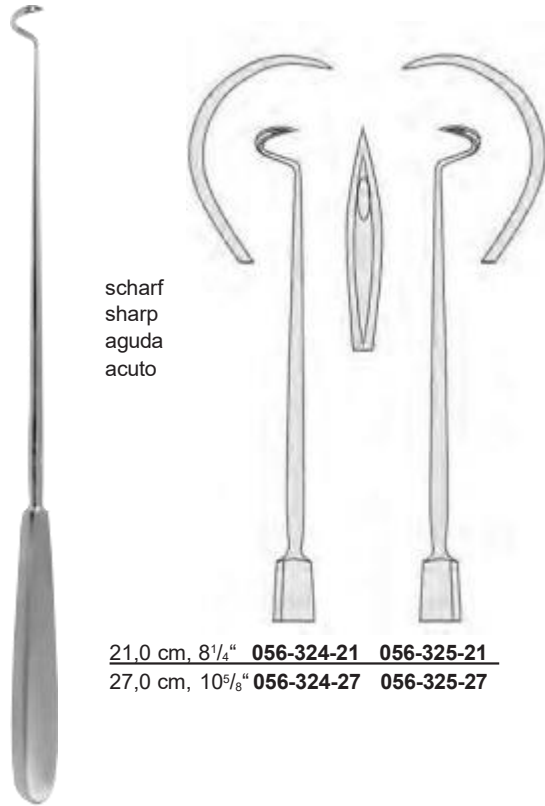

scharf
 sharp
 aguda
 acuto

21,0 cm, 8¹/₄" 056-324-21 056-325-21
 27,0 cm, 10⁵/₈" 056-324-27 056-325-27

DESCHAMPS

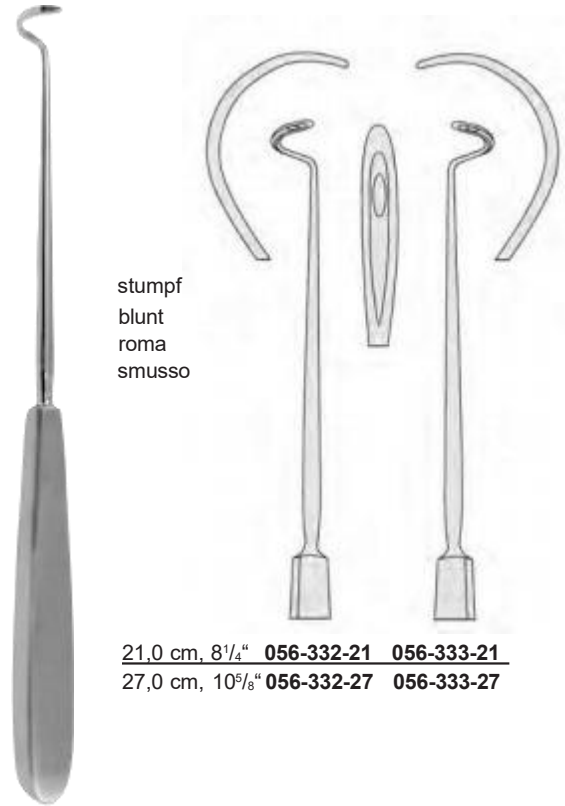

stumpf
 blunt
 roma
 smusso

21,0 cm, 8¹/₄" 056-332-21 056-333-21
 27,0 cm, 10⁵/₈" 056-332-27 056-333-27

DESCHAMPS



biegsam
 malleable
 maleable
 malleabile

20,0 cm, 8"
 056-450-20



COOPER
 19,0 cm, 7¹/₂"
 056-451-19



COOPER
 20,0 cm, 8"
 056-451-20

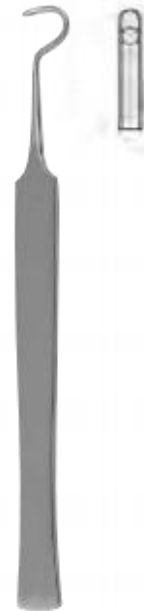

SYME
 15,0 cm, 6"
 056-453-15

Unterbindungsnadeln
Ligature Needles
Agujas para ligaduras
Aghi per legatura



056-452-01



056-452-02



056-452-03



BRUNNER
 25,0 cm, 9³/₄"
056-455-25



056-454-01



056-454-02

BRUNNER
 30,0 cm, 11³/₄"



SCHMIEDEN
 21,0 cm, 8¹/₄"
056-458-21

Unterbindungsnadeln
Ligature Needles
Agujas para ligaduras
Aghi per legatura



YOUNG-HRYNTSCHAK
24,0 cm, 9 1/2"
056-460-24



056-460-01



056-460-02



056-460-03



DE LA ROZA
12,0 cm, 4 3/4"
056-467-01



DE LA ROZA
12,0 cm, 4 3/4"
056-467-02



JAKOBI
14,0 cm, 5 1/2"
056-469-14



HESSEBERG
15,0 cm, 6"
056-468-15



KRONECKER
15,0 cm, 6"
056-470-01

Unterbindungsnadeln
 Ligature Needles
 Agujas para ligaduras
 Aghi per legatura



KRONECKER
 15,0 cm, 6"
 056-470-02



TRELAT
 23,0 cm, 9"
 056-472-23



CLAUS
 23,0 cm, 9"
 056-473-23



HURD
 21,0 cm, 8 1/4"
 056-474-01



HURD
 21,0 cm, 8 1/4"
 056-474-02



NAGER
 24,0 cm, 9 1/2"
 056-477-24



CLAUS-EICKEN
 23,0 cm, 9"
 056-481-23



FALK
 24,0 cm, 9 1/2"
 056-480-01



FALK
 24,0 cm, 9 1/2"
 056-480-02

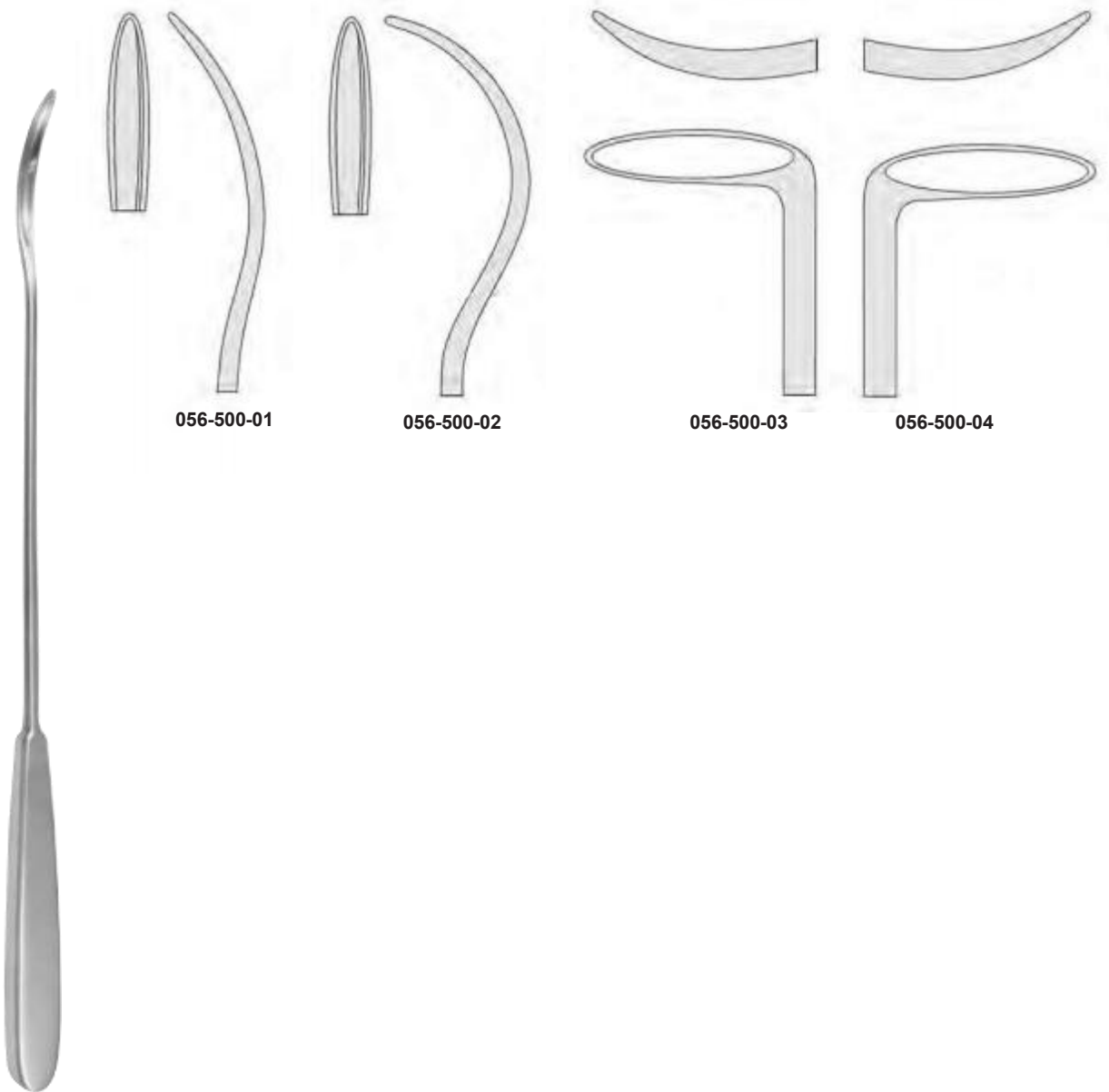

056-500-01

056-500-02

056-500-03

056-500-04

BRUNNER
30,0 cm, 11³/₄"

Führungshohlsonden
 Ligature Conductors
 Sondas conductoras
 Sonde conduttrici



PAYR
 22,0 cm, 8⁵/₈"
 056-502-22



PAYR
 22,0 cm, 8⁵/₈"
 056-503-22



mit Loch
 with hole
 con foro
 con ago

SCHMIEDEN-PAYR
 19,0 cm, 7¹/₂"
 056-506-19



ohne Loch
 without hole
 sin foro
 senza ago

SCHMIEDEN
 19,0 cm, 7¹/₂"
 056-507-19



KÖNIG
 19,5 cm, 7³/₄"
 056-508-03



KÖNIG
 19,5 cm, 7³/₄"
 056-508-05



KÖNIG
 19,5 cm, 7³/₄"
 056-508-07

Führungshohlsonden
 Ligature Conductors
 Sondas conductoras
 Sonde conduttrici

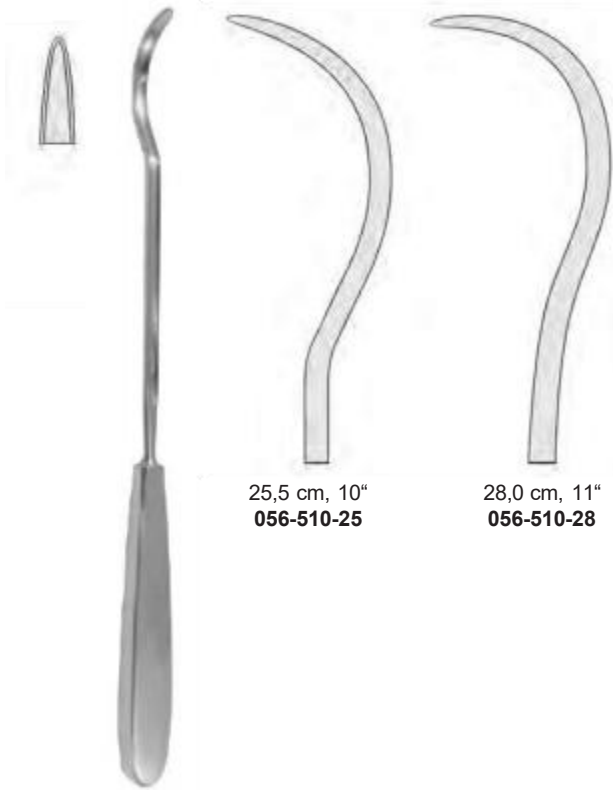

25,5 cm, 10"
056-510-25

28,0 cm, 11"
056-510-28

KIRSCHNER



BRUNNER-FERROZELL
 18,0 cm, 7" **056-521-18**
 27,0 cm, 10⁵/₈" **056-521-27**



15,0 cm, 6" **056-513-15** **056-514-15**
 16,0 cm, 6¹/₄" **056-513-16** **056-514-16**



18,0 cm, 7"
056-516-18

KOCHER

Nahtinstrumente
Suture Instruments
Instrumentos para sutura
Strumenti per sutura



MOD. WIEN
23,5 cm, 9¹/₄"
056-532-23



BOZEMANN
21,0 cm, 8¹/₄"
056-531-21



23,0 cm, 9"
056-530-23



MICHEL
12,0 cm, 4³/₄"
056-550-12



COLLIN
13,0 cm, 5"
056-552-13



RICHTER-HEATH
14,0 cm, 5¹/₂"
056-553-14



WACHENFELDT
12,5 cm, 5"
056-555-01



HEGENBARTH
12,5 cm, 5"
056-556-12



MICHEL
12,0 cm, 4³/₄"
056-558-12



LANGE
10,0 cm, 4"
056-559-10



CHILDE
18,0 cm, 7"
056-560-01



CHILDE CLIP
18,0 cm, 7"
056-560-02



- | | |
|-------------------|---------------|
| 056-570-08 | 7,5 x 1,75 mm |
| 056-570-11 | 11,0 x 2,0 mm |
| 056-570-12 | 12,0 x 3,0 mm |
| 056-570-14 | 14,0 x 3,0 mm |
| 056-570-16 | 16,0 x 3,0 mm |
| 056-570-18 | 18,0 x 3,0 mm |
| 056-570-20 | 20,0 x 3,0 mm |
| 056-570-22 | 22,0 x 3,0 mm |

MICHEL



CLIP-SET

056-558-00

bestehend aus, consisting of,
compuesto de, compostoda

- 1 x **056-558-12**
- 1 x **056-550-12**
- 50 x **056-570-14**
- 1 x **056-590-01** (Etui)



RISH SURGICAL

NAME OF TRUST

**Wundhaken
Retractors
Separadores
Divaricatori**



Dura- und Hauthäkchen
Dura and Skin Retractors
Gancho para piel y dura-madre
Unico per pelle e dura-madre



GILLIES
 18,0 cm, 7"



Fig. 1
062-050-01



Fig. 2
062-050-02



KILNER
 15,0 cm, 6"
062-054-15



FRAZIER
 13,0 cm, 5"
062-060-13



O'CONNOR
 16,0 cm, 6 1/4"
062-074-16



KLEINERT-KUTZ
 16,0 cm, 6 1/4"



Fig. 1
062-058-01



Fig. 2
062-058-02



Fig. 3
062-058-03



JOSEPH
 16,0 cm, 6 1/4"
062-062-16



GRAEFE
 16,0 cm, 6 1/4"



Fig. 1
062-078-01



Fig. 2
062-078-02

Dura- und Hauthäkchen
 Dura and Skin Retractors
 Gancho para piel y dura-madre
 Unico per pelle e dura-madre

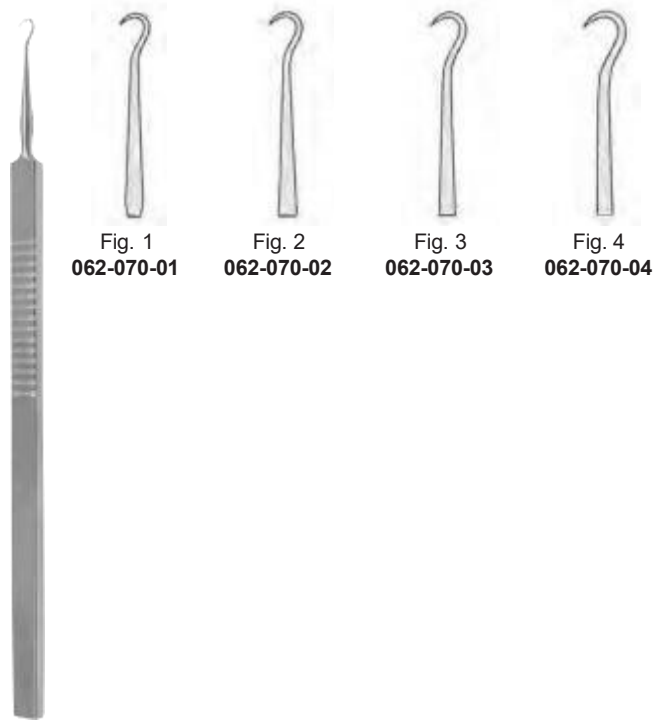

Fig. 1
 062-070-01

Fig. 2
 062-070-02

Fig. 3
 062-070-03

Fig. 4
 062-070-04

16,0 cm, 6 1/4"



Fig. 1
 062-080-01

Fig. 2
 062-080-02

GUTHRIE
 16,0 cm, 6 1/4"

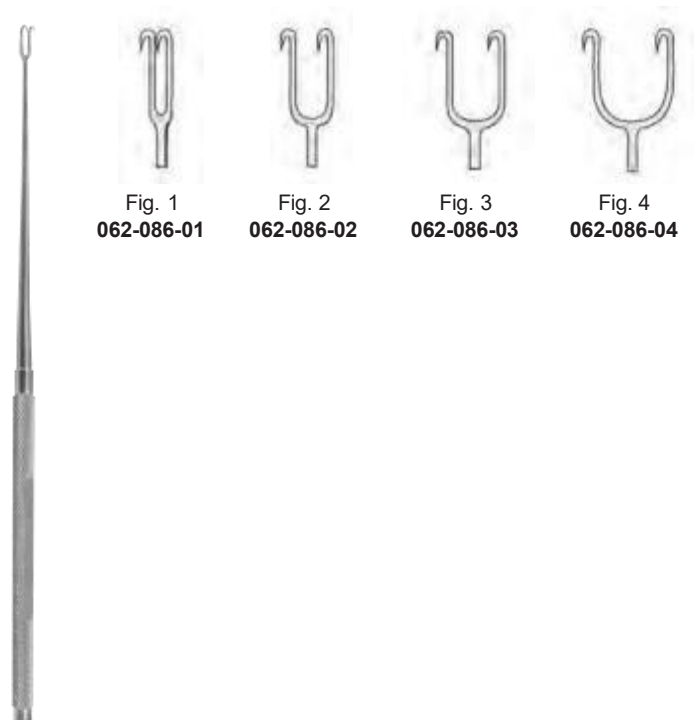

Fig. 1
 062-086-01

Fig. 2
 062-086-02

Fig. 3
 062-086-03

Fig. 4
 062-086-04

JOSEPH
 16,0 cm, 6 1/4"

Wundhaken
Retractors
Separadores
Divaricatori



KNAPP
13,0 cm, 5"



Fig. 1
062-082-01

scharf
sharp
agudos
acuti



Fig. 2
062-082-02

stumpf
blunt
romo
smusso



16,0 cm, 6 1/4"



062-088-02



062-088-03



062-088-04

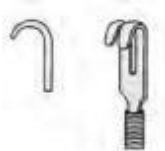

062-089-02



062-089-03



062-089-04

flexibel · flexible · flexibles · flessibili



16,0 cm, 6 1/4"



062-101-01



062-101-02



062-101-03



062-101-04

scharf
sharp
agudos
acuti



062-103-01



062-103-02



062-103-03



062-103-04

halbscharf
semi-sharp
semi-agudos
semi-acuti



062-102-01



062-102-02



062-102-03



062-102-04

stumpf
blunt
romo
smusso

**Wundhaken
Retractors
Separadores
Divaricatori**



16,0 cm, 6 1/4"

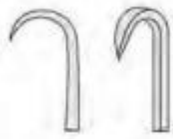

062-111-01



062-111-02



062-111-03



062-111-04

scharf
sharp
agudos
acuti



062-112-01



062-112-02



062-112-03



062-112-04

stumpf
blunt
romo
smusso



CUSHING
19,0 cm, 7 1/2"



Fig. 1
062-140-01



Fig. 2
062-140-02



LANGENBECK-GREEN
16,0 cm, 6 1/4"



16 x 6 mm
062-162-01



24 x 6 mm
062-162-02

Wundhaken
Retractors
Separadores
Divaricatori



MEYERDING
18,0 cm, 7"



18 x 7 mm
062-150-01



16 x 5 mm
062-150-02



7 x 4 mm
062-150-03



10 x 3 mm
062-150-04



7 x 4 mm
062-150-05



4 x 10 mm
062-150-06



14 x 8 mm
062-166-16

16,0 cm, 6 1/4"



SENN-GREEN
15,0 cm, 6"



10 x 6 mm
062-160-10



20 x 6 mm
062-160-20



MINI-LANGENBECK
16,0 cm, 6 1/4"



10 x 6 mm
062-164-01



17 x 5 mm
062-164-02



20 x 6 mm
062-164-03



22 x 8 mm
062-164-04

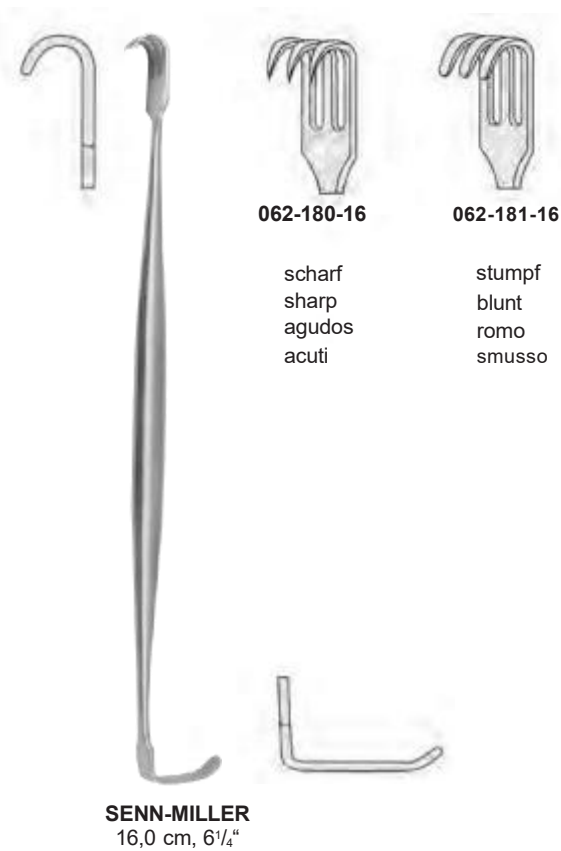
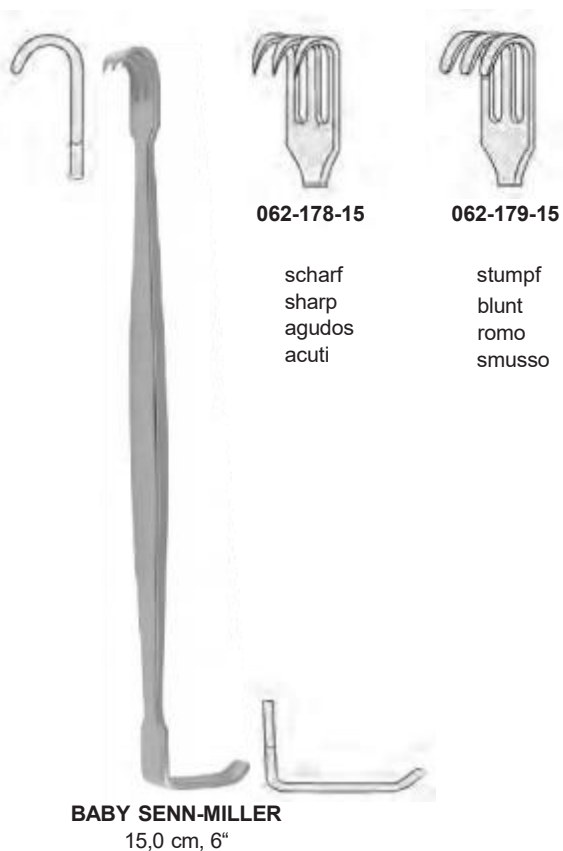

**Wundhaken
Retractors
Separadores
Divaricatori**



DESMARRES
13,0 cm, 5"



8 mm
062-200-08



10 mm
062-200-10



12 mm
062-200-12



14 mm
062-200-14



16 mm
062-200-16



18 mm
062-200-18



DESMARRES
16,0 cm, 6 1/4"



8 mm
062-204-08



10 mm
062-204-10



12 mm
062-204-12



14 mm
062-204-14



16 mm
062-204-16



18 mm
062-204-18



CUSHING
20,0 cm, 8"



8 mm
062-210-08



10 mm
062-210-10



12 mm
062-210-12



14 mm
062-210-14



16 mm
062-210-16



18 mm
062-210-18



CUSHING
24,0 cm, 9½"



8 mm
062-212-08



10 mm
062-212-10



12 mm
062-212-12



14 mm
062-212-14



16 mm
062-212-16



18 mm
062-212-18

Wundhaken
Retractors
Separadores
Divaricatori



GIL-VERNET
24,0 cm, 9½"



8 mm
062-220-08



11 mm
062-220-11



13 mm
062-220-13



17 mm
062-220-17



20 mm
062-220-20



23 mm
062-220-23



GIL-VERNET
24,0 cm, 9½"



8 mm
062-230-08



11 mm
062-230-11



13 mm
062-230-13



17 mm
062-230-17



20 mm
062-230-20



23 mm
062-230-23



ROUX

- Fig. 1 24 x 20 mm
- Fig. 2 29 x 26 mm
- Fig. 3 33 x 29 mm
- Fig. 4 29 x 24 mm

Satz, Fig. 1-3
Set, fig. 1-3
Juego, fig. 1-3
Serie, fig. 1-3

- Fig. 1 30 x 28 mm
- Fig. 2 36 x 36 mm
- Fig. 3 38 x 43 mm
- Fig. 4 45 x 28 mm

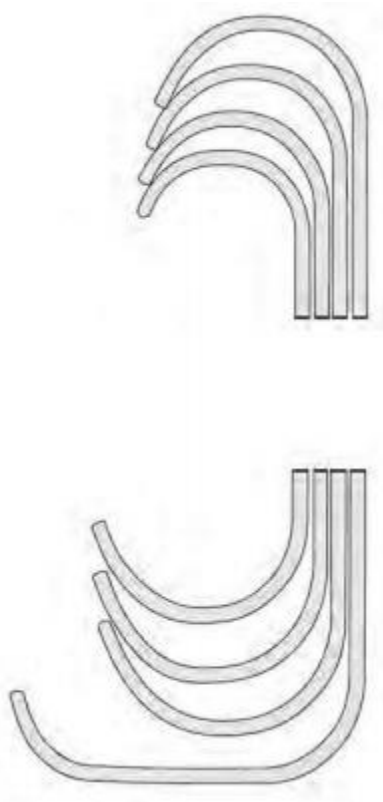

- Fig. 1-3 17,0 cm, 6³/₄" **062-310-00**
- Fig. 1 14,0 cm, 5¹/₂" **062-310-01**
- Fig. 2 15,0 cm, 6" **062-310-02**
- Fig. 3 17,0 cm, 6³/₄" **062-310-03**
- Fig. 4 18,0 cm, 7" **062-310-04**



FARABEUF
12,0 cm, 4³/₄"
062-300-12

- Fig. 2 30 x 10 mm
- Fig. 1 26 x 10 mm

- Fig. 1 30 x 13 mm
- Fig. 2 34 x 13 mm



FARABEUF
15,0 cm, 5³/₄"
062-302-15

- Fig. 2 23 x 16 mm
- Fig. 1 27 x 16 mm

- Fig. 1 26 x 16 mm
- Fig. 2 30 x 16 mm

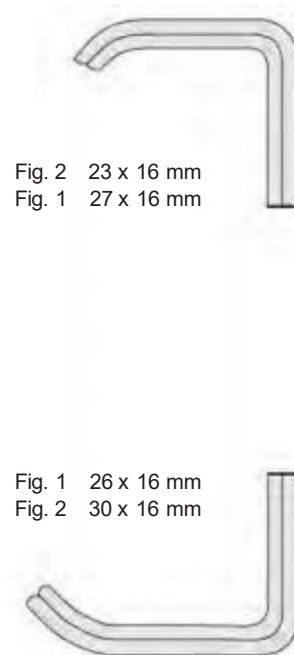

Wundhaken
Retractors
Separadores
Divaricatori



MINI-ROUX
14,0 cm, 5½"
062-340-06



BABY-ROUX
13,0 cm, 5"
062-342-13

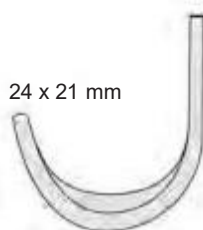

PARKER
13,5 cm, 5⅜"
062-350-00

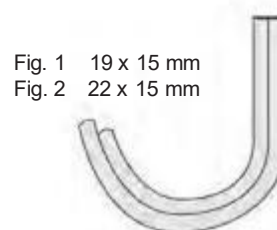
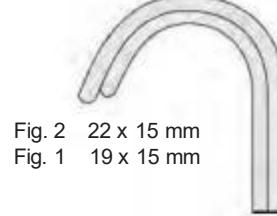

CZERNY
17,5 cm, 7"
062-360-00



MATHIEU
20,0 cm, 8"
062-380-00

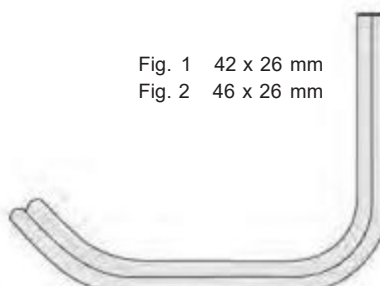
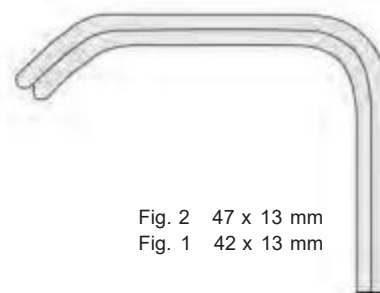

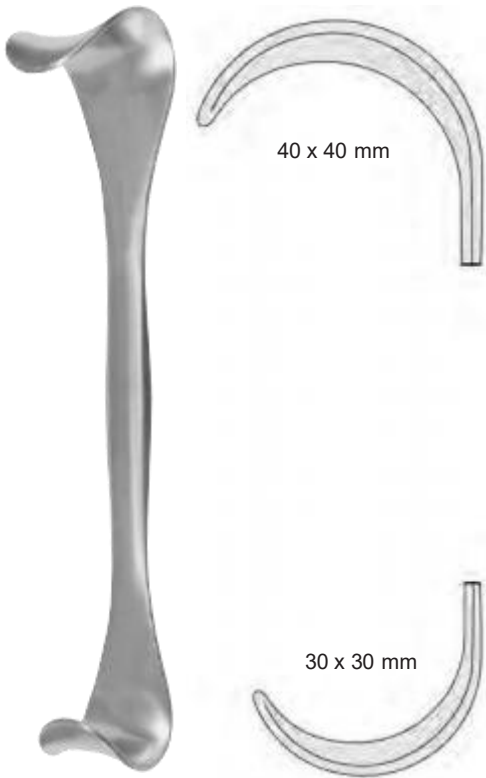

GOELET
19,0 cm, 7½"
062-396-19

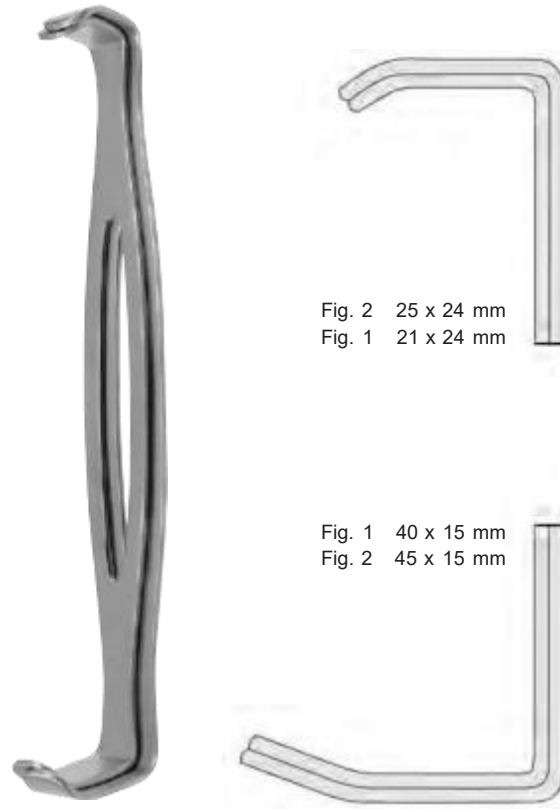

PARKER-LANGENBECK
21,0 cm, 8¼"
062-390-00



16 mm	19,0 cm, 7½"	062-370-16
20 mm	19,0 cm, 7½"	062-370-20
25 mm	20,0 cm, 8"	062-370-25

CANNY RYAL

Wundhaken
 Retractors
 Separadores
 Divaricatori



VOLKMANN
 21,5 cm, 8½"



064-001-01



9 x 8 mm
064-001-02



9 x 13 mm
064-001-03



9 x 19 mm
064-001-04



9 x 29 mm
064-001-06



9 x 40 mm
064-001-08

scharf
 sharp
 agudos
 acuti



VOLKMANN
 21,5 cm, 8½"



064-003-01



9 x 8 mm
064-003-02



9 x 13 mm
064-003-03



9 x 19 mm
064-003-04



9 x 29 mm
064-003-06



9 x 40 mm
064-003-08

halbscharf
 semi-sharp
 semi-agudos
 semi-acuti

Wundhaken
Retractors
Separadores
Divaricatori



VOLKMANN
21,5 cm, 8½"



064-002-01



9 x 8 mm
064-002-02



9 x 13 mm
064-002-03



9 x 19 mm
064-002-04



9 x 29 mm
064-002-06



9 x 40 mm
064-002-08

stumpf
blunt
romo
smusso



KOCHER
22,0 cm, 8⅝"



064-011-01

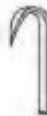

9 x 8 mm
064-011-02



15 x 15 mm
064-011-03



15 x 20 mm
064-011-04



15 x 30 mm
064-011-06



15 x 40 mm
064-011-08

scharf
sharp
agudos
acuti

Wundhaken
Retractors
Separadores
Divaricatori



KOCHER
22,0 cm, 8⁵/₈"



064-013-01



9 x 8 mm
064-013-02



15 x 15 mm
064-013-03



15 x 20 mm
064-013-04



15 x 30 mm
064-013-06



15 x 40 mm
064-013-08

halbscharf
semi-sharp
semi-agudos
semi-acuti



KOCHER
22,0 cm, 8⁵/₈"



064-012-01



9 x 8 mm
064-012-02



15 x 15 mm
064-012-03



15 x 20 mm
064-012-04



15 x 30 mm
064-012-06



15 x 40 mm
064-012-08

stumpf
blunt
romo
smusso

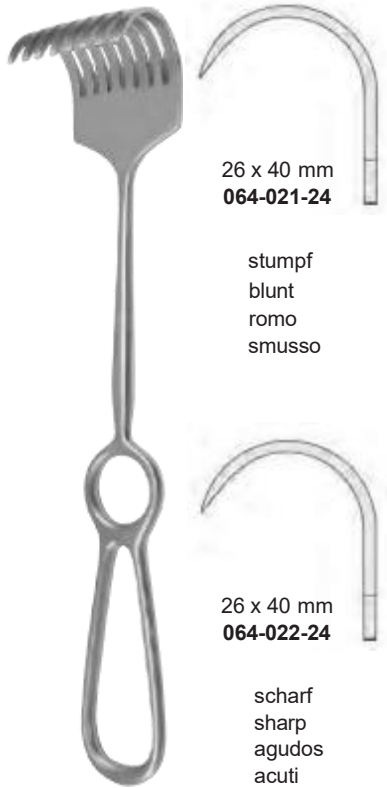

26 x 40 mm
064-021-24

stumpf
blunt
romo
smusso

26 x 40 mm
064-022-24

scharf
sharp
agudos
acuti

KOERTE
24,0 cm, 9½"

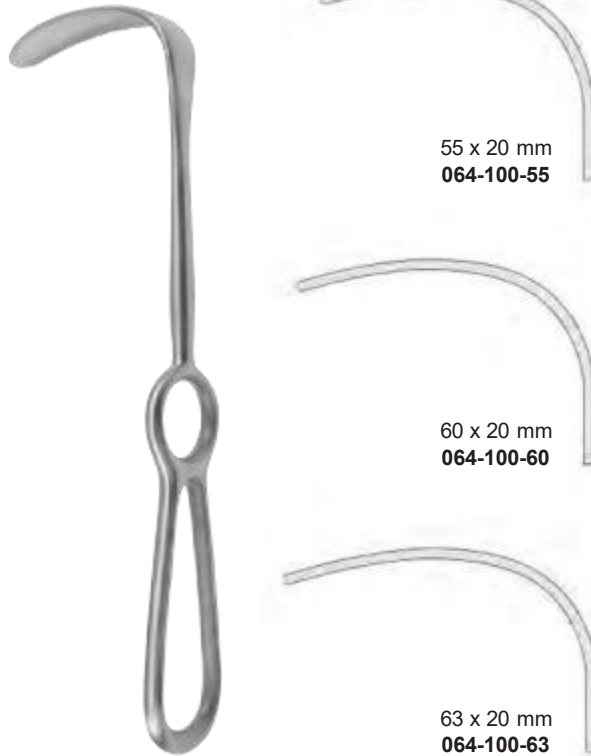

55 x 20 mm
064-100-55

60 x 20 mm
064-100-60

63 x 20 mm
064-100-63

LANGENBECK
21,0 cm, 8¼"



ISRAEL
25,0 cm, 9¾"

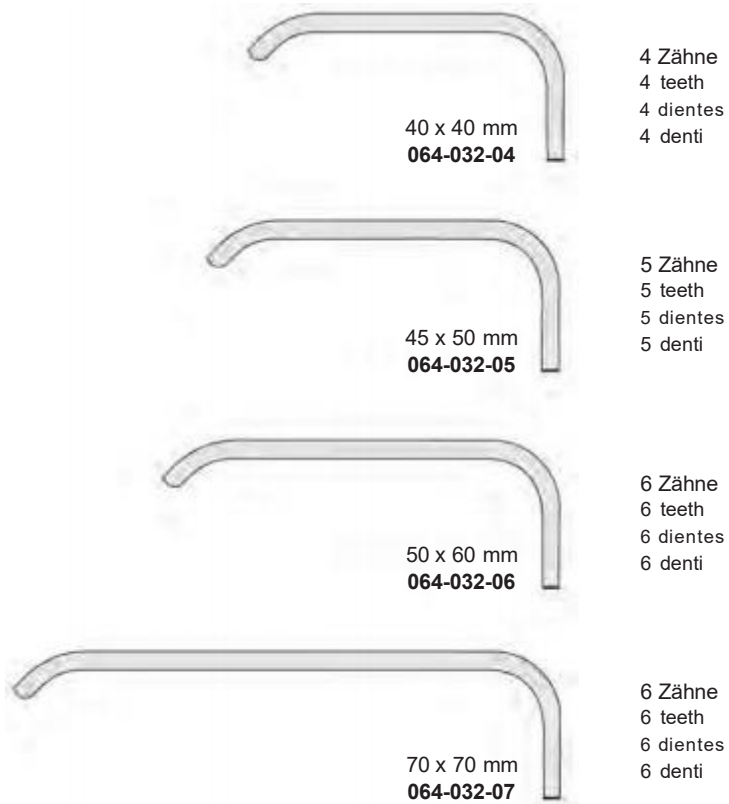

40 x 40 mm
064-032-04

4 Zähne
4 teeth
4 dientes
4 denti

45 x 50 mm
064-032-05

5 Zähne
5 teeth
5 dientes
5 denti

50 x 60 mm
064-032-06

6 Zähne
6 teeth
6 dientes
6 denti

70 x 70 mm
064-032-07

6 Zähne
6 teeth
6 dientes
6 denti

Wundhaken
Retractors
Separadores
Divaricatori



LANGENBECK
22,0 cm, 8⁵/₈"



30 x 11 mm
064-110-30



30 x 14 mm
064-110-31



30 x 16 mm
064-110-32



40 x 11 mm
064-110-40

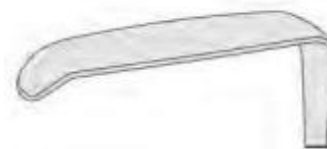

50 x 11 mm
064-110-50



LANGENBECK
22,0 cm, 8⁵/₈"



30 x 11 mm
064-120-30



30 x 14 mm
064-120-31



30 x 16 mm
064-120-32



40 x 11 mm
064-120-40



50 x 11 mm
064-120-50



KOCHER-LANGENBECK
21,5 cm, 8½"

	22 x 6 mm 064-130-22
	25 x 6 mm 064-130-25
	25 x 8 mm 064-130-26
	35 x 8 mm 064-130-35
	35 x 11 mm 064-130-36
	35 x 15 mm 064-130-37
	40 x 11 mm 064-130-40
	70 x 14 mm 064-130-70
	80 x 12 mm 064-130-80
	80 x 16 mm 064-130-85

Wundhaken
Retractors
Separadores
Divaricatori



KOCHER
23,0 cm, 9"



40 x 18 mm
064-140-18



60 x 20 mm
064-140-20



60 x 25 mm
064-140-25



75 x 30 mm
064-140-30



75 x 40 mm
064-140-40



SAUERBRUCH
22,5 cm, 8³/₄"



44 x 16 mm
064-150-44



55 x 22 mm
064-150-55



72 x 19 mm
064-150-72



MIDDELDORPF



21,5 cm, 8½"
14 x 17 mm
064-180-01



22,0 cm, 8⅝"
20 x 22 mm
064-180-02



23,5 cm, 9¼"
26 x 30 mm
064-180-03



MIDDELDORPF



21,5 cm, 8½"
14 x 17 mm
064-182-01



22,0 cm, 8⅝"
20 x 22 mm
064-182-02



23,5 cm, 9¼"
26 x 30 mm
064-182-03



RICHARDSON (KELLY)
24,0 cm, 9½"



28 x 20 mm
064-210-02



36 x 28 mm
064-210-03



44 x 38 mm
064-210-04



52 x 22 mm
064-210-05

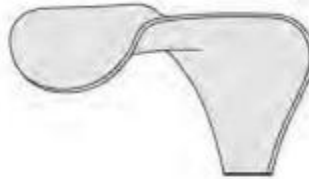

65 x 50 mm
064-210-06

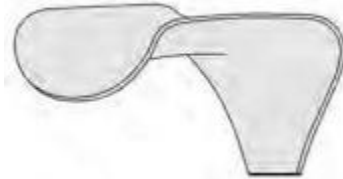

70 x 65 mm
064-210-07

**Wundhaken
Retractors
Separadores
Divaricatori**

49 x 38 mm

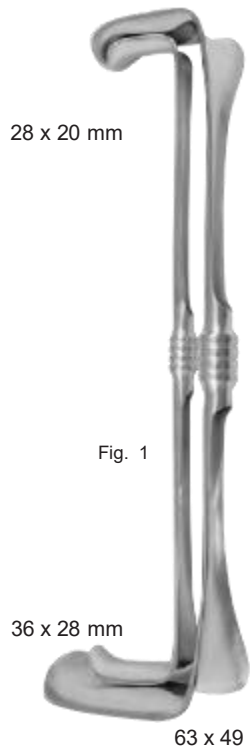

28 x 20 mm

Fig. 2

Fig. 1

36 x 28 mm

63 x 49 mm

RICHARDSON-EASTMAN

Fig. 1+2	28,0 cm, 11"	062-200-00
Fig. 1	26,0 cm, 10 ¹ / ₄ "	062-200-01
Fig. 2	28,0 cm, 11"	062-200-02



MIDDELDORPF
25,5 cm, 10"



40 x 45 mm	064-192-01
45 x 50 mm	064-192-02
55 x 70 mm	064-192-03



FRITSCH
24,0 cm, 9¹/₂"



45 x 40 mm	064-240-40
45 x 50 mm	064-240-50
45 x 60 mm	064-240-60
55 x 75 mm	064-240-75
65 x 85 mm	064-240-85



DOYEN
25,0 cm, 10"
064-230-50

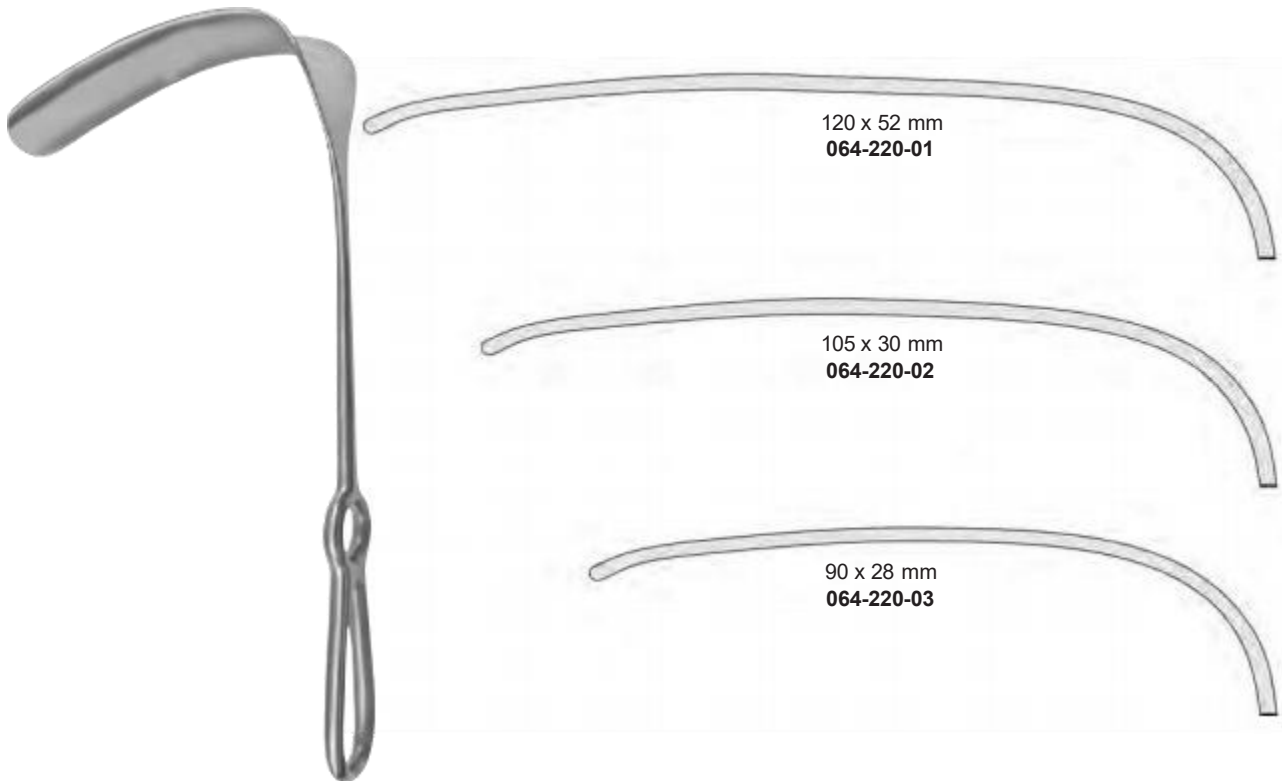

120 x 52 mm
064-220-01

105 x 30 mm
064-220-02

90 x 28 mm
064-220-03

DOYEN-STILLE
22,0 cm, 8⁵/₈"



70 x 25 mm **064-250-70**
80 x 42 mm **064-250-81**
80 x 50 mm **064-250-82**
80 x 60 mm **064-250-83**

KOCHER
25,0 cm, 10"

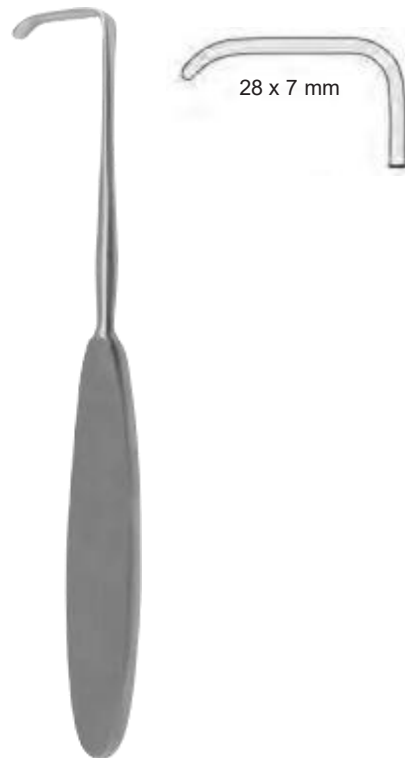

28 x 7 mm

LAHEY
19,0 cm, 7¹/₂"
061-160-19

Wundhaken
 Retractors
 Separadores
 Divaricatori



12 x 13 mm



LITTLE
 20,0 cm, 8"
 064-164-20



SIMON
 28,0 cm, 11"
 115 x 22 mm 064-260-01
 115 x 27 mm 064-260-02



160 x 38 mm 064-280-61
 160 x 57 mm 064-280-62
 190 x 38 mm 064-280-91
 190 x 57 mm 064-280-92

KELLY
 27,0 cm, 10½"



85 x 35 mm **064-274-01**
120 x 50 mm **064-274-02**
150 x 50 mm **064-274-03**

MIKULICZ
26,0 cm, 10¹/₄"



90 x 50 mm

MIKULICZ
26,0 cm, 10¹/₄"
064-272-90



70 x 38 mm **064-290-38**
70 x 50 mm **064-290-51**

MORRIS
24,5 cm, 9⁵/₈"

Wundhaken
 Retractors
 Separadores
 Divaricatori



127 x 40 mm **064-500-40**
127 x 62 mm **064-500-62**

HARRINGTON
 32,0 cm, 12½"



82 x 22 mm **064-390-01**
108 x 43 mm **064-390-02**
115 x 65 mm **064-390-03**

CORYKKOS
 24,0 cm, 9½"



ZENKER

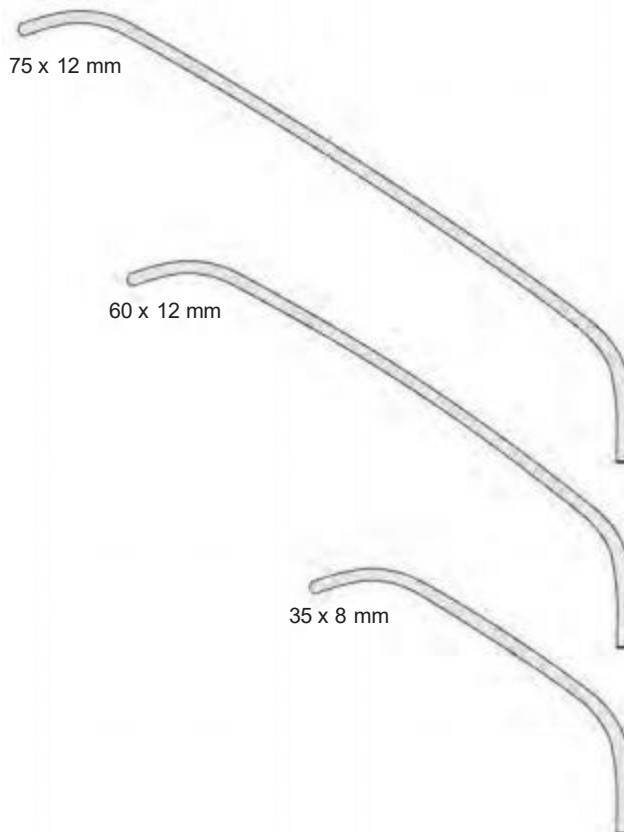

75 x 12 mm

60 x 12 mm

35 x 8 mm

25,0 cm, 9¾"
064-320-25

26,0 cm, 10¼"
064-320-26

27,5 cm, 10¾"
064-320-27

Wundhaken
Retractors
Separadores
Divaricatori



MEYERDING
22,5 cm, 8³/₄"

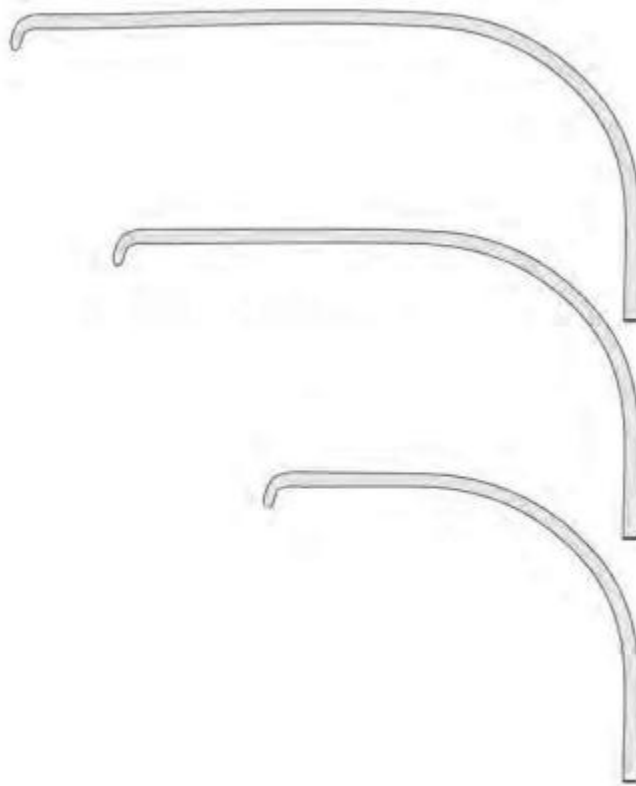

90 x 50 mm
064-350-50

75 x 25 mm
064-350-25

50 x 16 mm
064-350-16



BRUNNER
25,0 cm, 10"

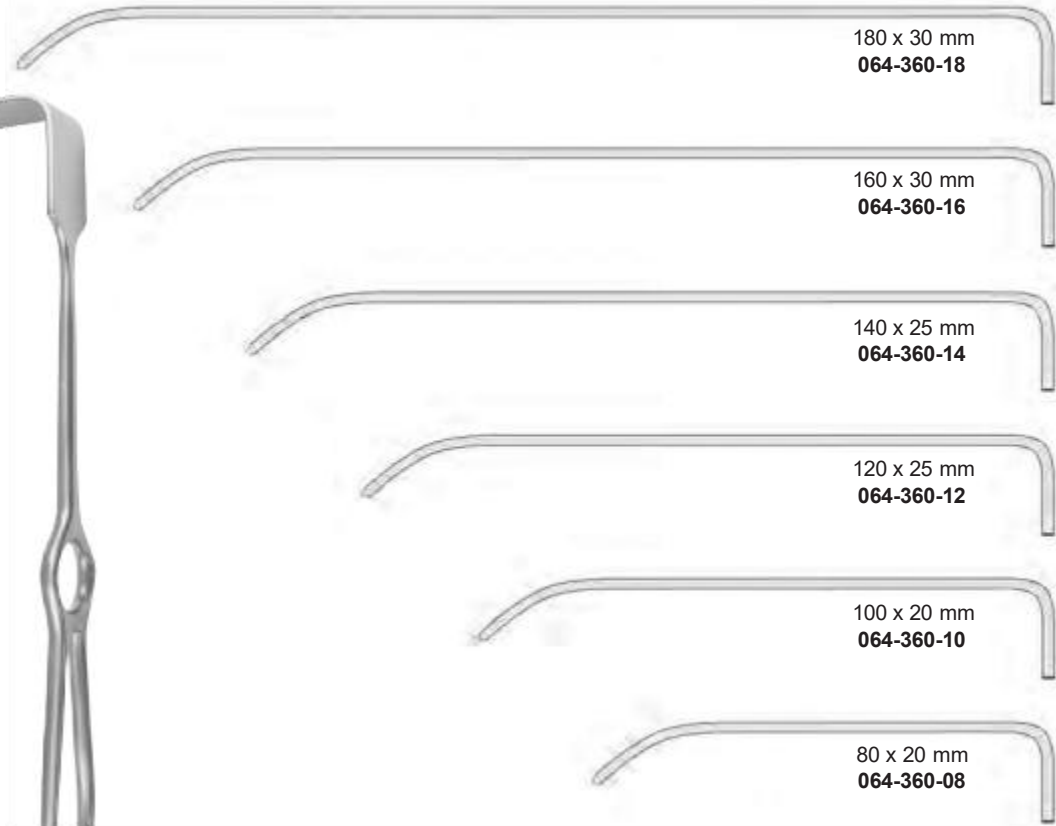

180 x 30 mm
064-360-18

160 x 30 mm
064-360-16

140 x 25 mm
064-360-14

120 x 25 mm
064-360-12

100 x 20 mm
064-360-10

80 x 20 mm
064-360-08

Wundhaken
 Retractors
 Separadores
 Divaricatori



BRUNNER
 25,0 cm, 10"

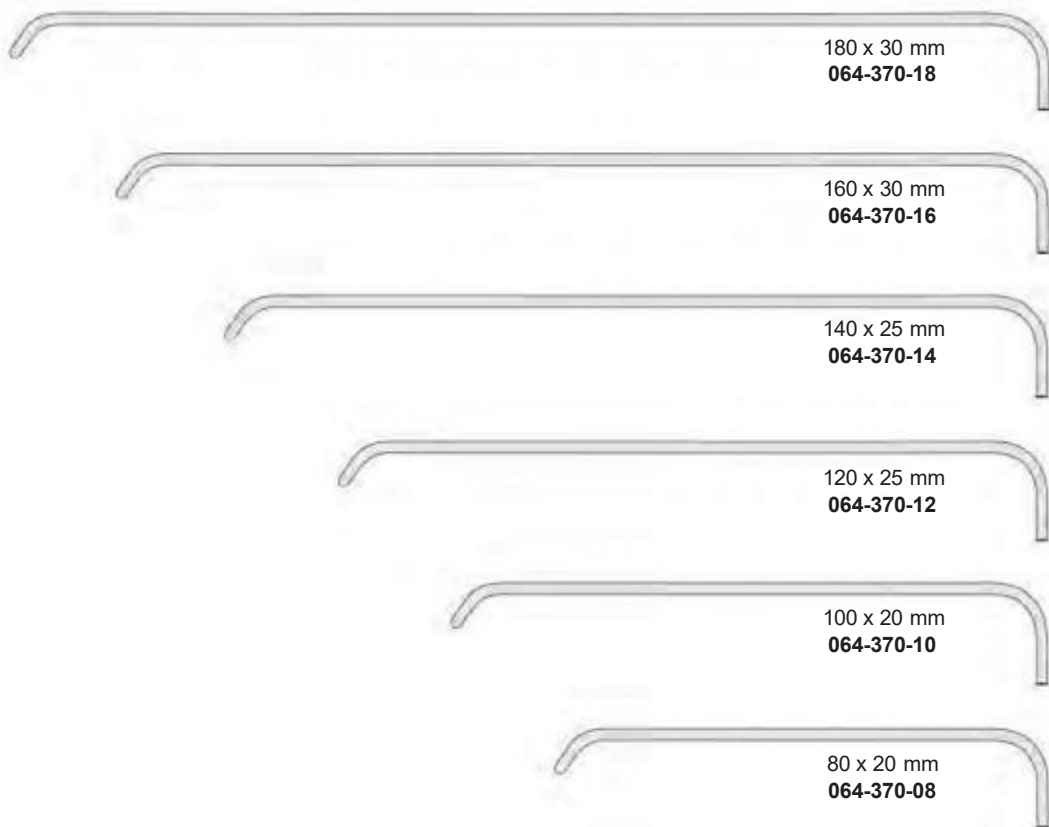

180 x 30 mm
064-370-18

160 x 30 mm
064-370-16

140 x 25 mm
064-370-14

120 x 25 mm
064-370-12

100 x 20 mm
064-370-10

80 x 20 mm
064-370-08



19 mm

DEAVER
 18,0 cm, 7"
064-602-18



22 mm

DEAVER
 21,5 cm, 8 1/2"
064-602-22



25 mm

DEAVER
 23,0 cm, 9"
064-602-23



DEAVER
30,0 cm, 11³/₄"
064-604-30



DEAVER
33,0 cm, 13"
064-604-33



DEAVER
36,0 cm, 14¹/₈"
064-604-36



DEAVER
30,0 cm, 11³/₄"
064-610-38



DEAVER
30,0 cm, 11³/₄"
064-610-50



DEAVER
30,0 cm, 11³/₄"
064-610-75

Wundhaken
Retractors
Separadores
Divaricatori



25 mm	064-600-25
38 mm	064-600-38
50 mm	064-600-50
75 mm	064-600-75

DEAVER
30,0 cm, 11³/₄"



40 mm	30,0 cm, 11 ³ / ₄ "	064-700-30
54 mm	32,0 cm, 12 ¹ / ₂ "	064-700-32

ALLISON



75 x 50 mm	16,0 cm, 6 ¹ / ₄ "	064-710-50
75 x 90 mm	16,0 cm, 6 ¹ / ₄ "	064-710-90

DAVIDSON



ST MARKS

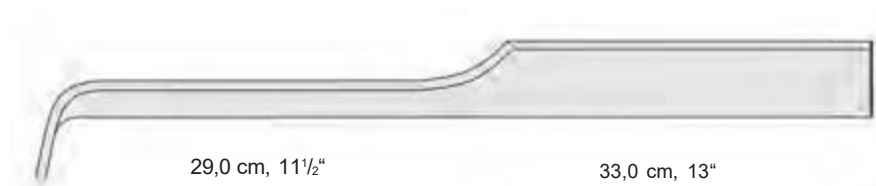

29,0 cm, 11¹/₂"
130 x 60 mm
064-720-01

33,0 cm, 13"
180 x 60 mm
064-720-02



29,0 cm, 11¹/₂"
130 x 60 mm
064-721-01

33,0 cm, 13"
180 x 60 mm
064-721-02















RISH SURGICAL

NAME OF TRUST

Wundspreizer
Self-Retaining Retractors
Separadores con retenida automática
Divaricatori autostatici

Wundspreizer
Self-Retaining Retractors
Separadores con retenida automática
Divaricatori autostatici

					
	5,0 cm, 2" 070-610-05	5,0 cm, 2" 070-611-05			
					
	7,0 cm, 2 ³ / ₄ " 070-610-07	7,0 cm, 2 ³ / ₄ " 070-611-07			
	scharf sharp agudos acuti	stumpf blunt romo smusso			
FINSEN					
					
			JANSEN 10,0 cm, 4"		
					
				070-630-10 scharf sharp agudos acuti	070-631-10 stumpf blunt romo smusso

		scharf sharp agudos acuti	halbscharf semi-sharp semi-agudos semi-acuti	stumpf blunt romo smusso	
					
	7,0 cm, 2 ³ / ₄ " 070-620-07	070-622-07	070-621-07		
	10,0 cm, 4" 070-620-10	070-622-10	070-621-10		
					
ALM					
					
				ALLPORT 9,5 cm, 3 ³ / ₄ " 070-626-09	

Wundspreizer
Self-Retaining Retractors
Separadores con retenida automática
Divaricatori autostatici



SALP-CONTOUR
 14,0 cm, 5 1/2"



ADSON-BABY
 16,0 cm, 6 1/4"



ANDERSON-ADSON
 19,0 cm, 8"

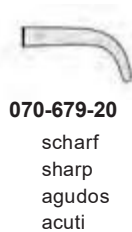
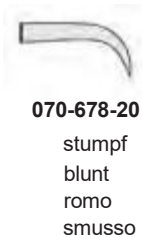

ADSON
 26,5 cm, 10 1/2"

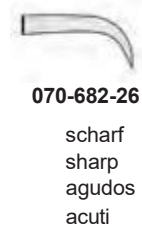

Wundspreizer
 Self-Retaining Retractors
 Separadores con retenida automática
 Divaricatori autostatici

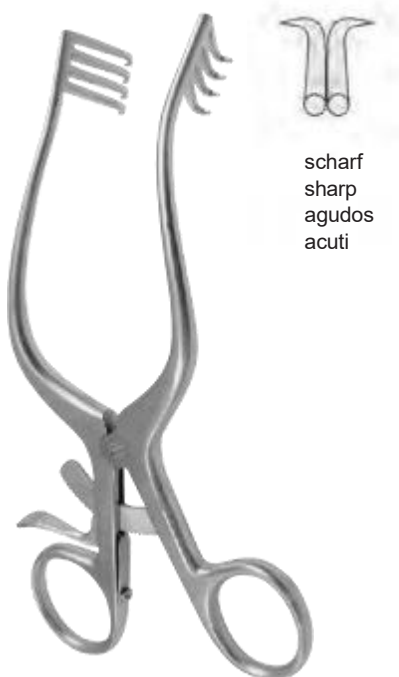

scharf
 sharp
 agudos
 acuti

MOLLISON
 15,5 cm, 6"
 070-674-15



070-800-12

scharf
 sharp
 agudos
 acuti

070-801-12

stumpf
 blunt
 romo
 smuss

SCHUHKNECHT
 12,5 cm, 5"

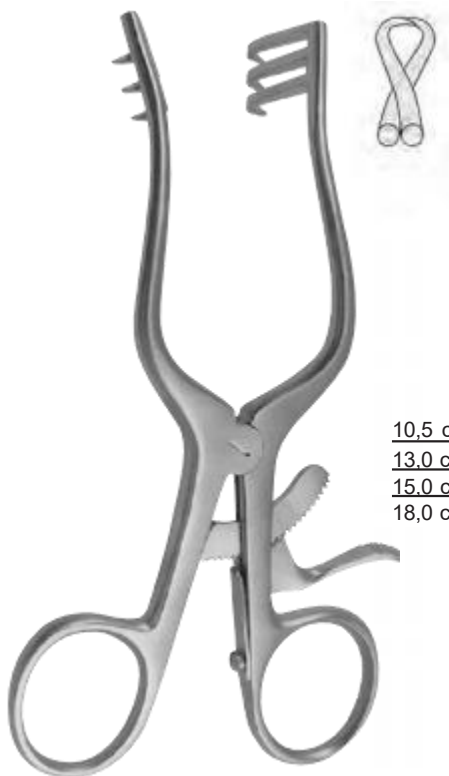

scharf stumpf
 sharp blunt
 agudos romo
 acuti smusso

- | | | |
|-----------------|-------------------|-------------------|
| 10,5 cm, 4 1/8" | 070-810-10 | 070-811-10 |
| 13,0 cm, 5" | 070-810-13 | 070-811-13 |
| 15,0 cm, 6" | 070-810-15 | 070-811-15 |
| 18,0 cm, 7" | 070-810-18 | 070-811-18 |

WULLSTEIN

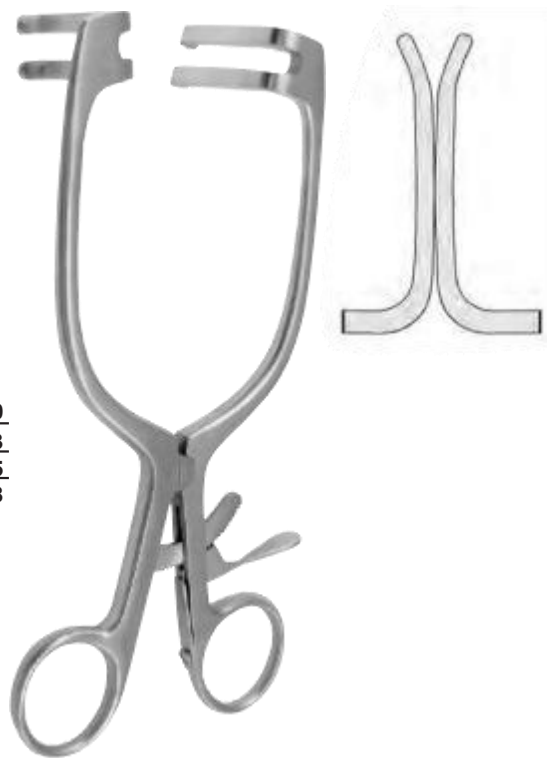

MAYO-ADAMS
 16,5 cm, 6 1/2"
 070-822-17

Wundspreizer
Self-Retaining Retractors
Separadores con retenida automática
Divaricatori autostatici



WEITLANER-LOKTITE
 10,5 cm, 4 1/8"



070-650-10
 scharf
 sharp
 agudos
 acuti



070-651-10
 stumpf
 blunt
 romo
 smusso



WEITLANER
 13,0 cm, 5"



070-670-13
 scharf
 sharp
 agudos
 acuti



070-671-13
 stumpf
 blunt
 romo
 smusso



WEITLANER
 16,5 cm, 6 1/2"



070-670-16
 scharf
 sharp
 agudos
 acuti



070-671-16
 stumpf
 blunt
 romo
 smusso



WEITLANER
 20,0 cm, 8"



070-670-20
 scharf
 sharp
 agudos
 acuti



070-671-20
 stumpf
 blunt
 romo
 smusso

Wundspreizer
 Self-Retaining Retractors
 Separadores con retenida automática
 Divaricatori autostatici



WEITLANER
 24,0 cm, 9½"

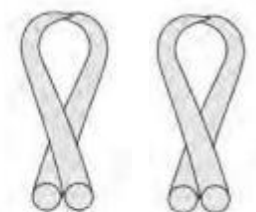

070-670-24 **070-671-24**

scharf
 sharp
 agudos
 acuti

stumpf
 blunt
 romo
 smusso



PLESTER
 13,0 cm, 5"

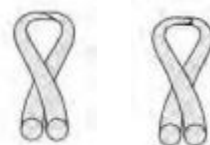

070-830-13 **070-831-13**

scharf
 sharp
 agudos
 acuti

stumpf
 blunt
 romo
 smusso



MILLIGAN
 13,0 cm, 5"
 070-840-13

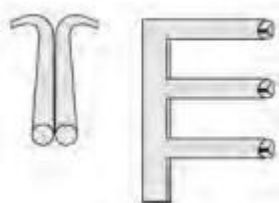

PLESTER
 11,0 cm, 4¾"
 070-672-11



PLESTER
 11,0 cm, 4¾"
 070-673-11

Wundspreizer
Self-Retaining Retractors
Separadores con retenida automática
Divaricatori autostatici



WEITLANER-BABY
 13,0 cm, 5"
 070-850-13



ADSON
(CONE)

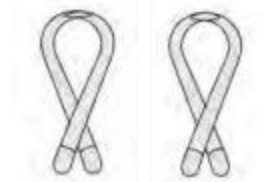

20,0 cm, 8" **070-860-20 070-861-20**
 26,0 cm, 10 1/4" **070-860-26 070-861-26**

scharf stumpf
 sharp blunt
 agudos romo
 acuti smusso

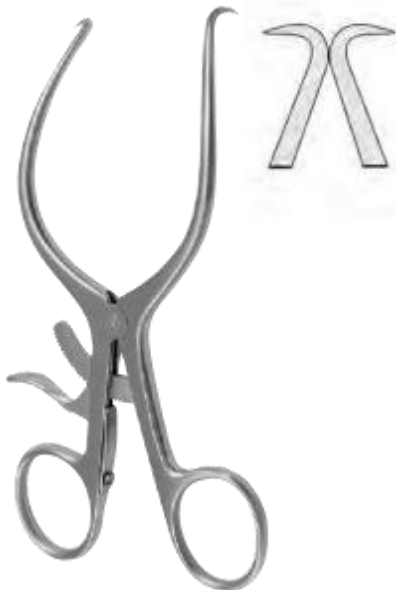

GELPI
 13,5 cm, 5 3/8"
 070-202-14



GELPI
 19,0 cm, 7 1/2"
 070-202-19



GELPI-LOKTITE
 18,0 cm, 7 1/2"
 070-250-19

Wundspreizer
 Self-Retaining Retractors
 Separadores con retenida automática
 Divaricatori autostatici

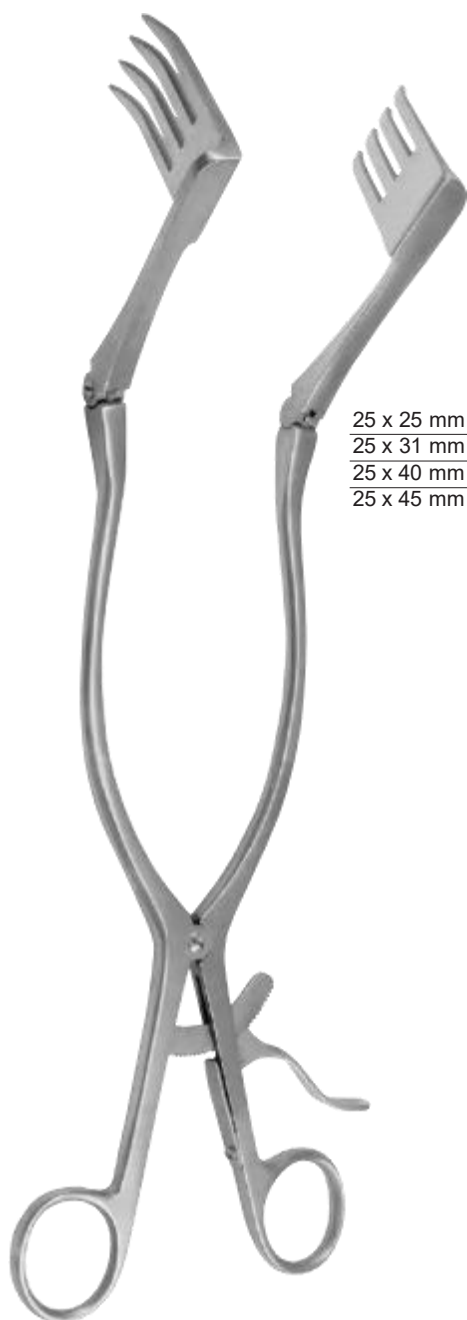

BECKMANN-ADSON
 31,0 cm, 12 1/4"

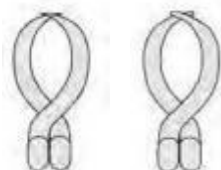

25 x 25 mm	070-870-01	070-871-01
25 x 31 mm	070-870-02	070-871-02
25 x 40 mm	070-870-03	070-871-03
25 x 45 mm	070-870-04	070-871-04

scharf	stumpf
sharp	blunt
agudos	romo
acuti	smusso

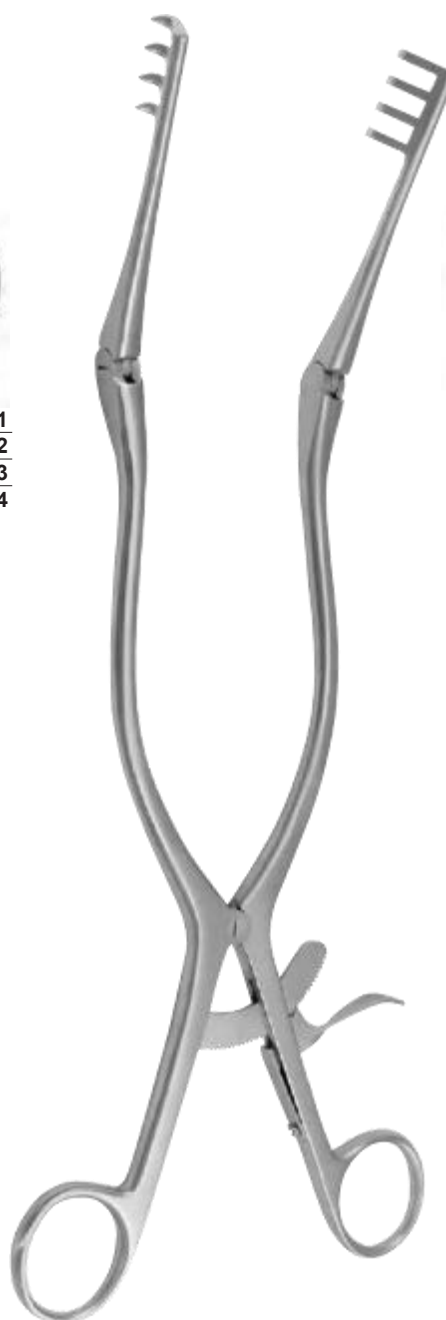

BECKMANN
 31,0 cm, 12 1/4"



070-690-31
 scharf
 sharp
 agudos
 acuti

Wundspreizer
Self-Retaining Retractors
Separadores con retenida automática
Divaricatori autostatici



BECKMANN
32,0 cm, 12½"



070-691-32
stumpf
blunt
romo
smusso



DE BAKEY

10,0 cm, 4" **070-240-10**
14,0 cm, 5½" **070-240-14**

Wundspreizer
 Self-Retaining Retractors
 Separadores con retenida automática
 Divaricatori autostatici



stumpf
 blunt
 romo
 smusso

NORFOLK AND NORWICH
 22,0 cm, 8⁵/₈"
 070-401-22



stumpf
 blunt
 romo
 smusso

JACKSON BURROWS
 17,5 cm, 7"
 070-411-17



RICHTER
 17,0 cm, 6³/₄"
 070-420-17



JOLL (FRIEDMAN)
 15,5 cm, 6"
 070-430-15

Wundspreizer
Self-Retaining Retractors
Separadores con retenida automática
Divaricatori autostatici

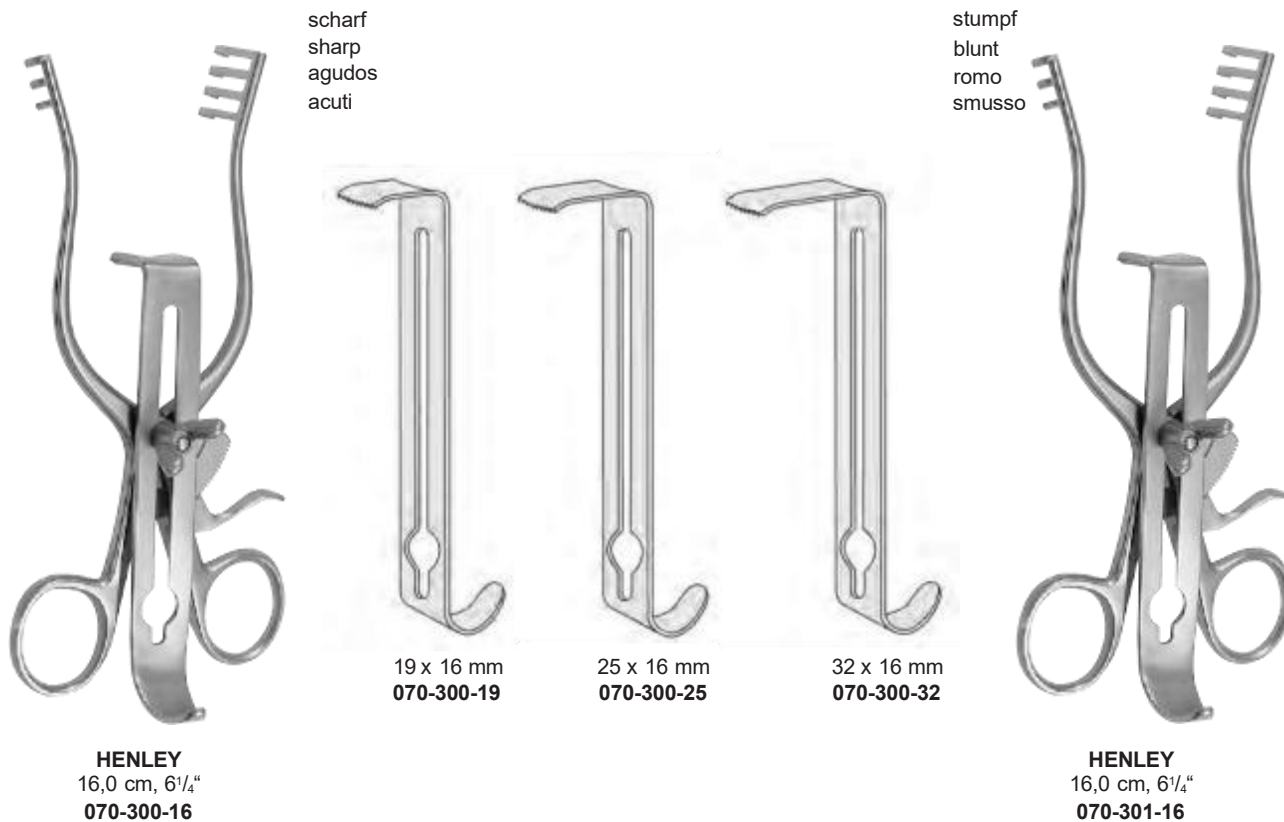

HENLEY
 16,0 cm, 6¼"
070-300-16

HENLEY
 16,0 cm, 6¼"
070-301-16

HENLEY
070-300-00

komplett, bestehend aus:

- 1 Sperrer mit Seitenvalven, scharf (30-1300-16)
- 1 Mittelvalve 19 x 16 mm (30-1300-19)
- 1 Mittelvalve 25 x 16 mm (30-1300-25)
- 1 Mittelvalve 32 x 16 mm (30-1300-32)

complete, consisting of:

- 1 Spreader with lateral valves, sharp (30-1300-16)
- 1 Central valve 19 x 16 mm (30-1300-19)
- 1 Central valve 25 x 16 mm (30-1300-25)
- 1 Central valve 32 x 16 mm (30-1300-32)

completo, compuesto of:

- 1 Separador con valvas laterales, agudas (30-1300-16)
- 1 Valva central 19 x 16 mm (30-1300-19)
- 1 Valva central 25 x 16 mm (30-1300-25)
- 1 Valva central 32 x 16 mm (30-1300-32)

completo, compostoda:

- 1 Divaricatore con valve laterali, acuto (30-1300-16)
- 1 Valva centrale 19 x 16 mm (30-1300-19)
- 1 Valva centrale 25 x 16 mm (30-1300-25)
- 1 Valva centrale 32 x 16 mm (30-1300-32)

HENLEY
070-301-00

komplett, bestehend aus:

- 1 Sperrer mit Seitenvalven, stumpf (30-1301-16)
- 1 Mittelvalve 19 x 16 mm (30-1300-19)
- 1 Mittelvalve 25 x 16 mm (30-1300-25)
- 1 Mittelvalve 32 x 16 mm (30-1300-32)

complete, consisting of:

- 1 Spreader with lateral valves, blunt (30-1301-16)
- 1 Central valve 19 x 16 mm (30-1300-19)
- 1 Central valve 25 x 16 mm (30-1300-25)
- 1 Central valve 32 x 16 mm (30-1300-32)

completo, compuesto of:

- 1 Separador con valvas laterales, romas (30-1301-16)
- 1 Valva central 19 x 16 mm (30-1300-19)
- 1 Valva central 25 x 16 mm (30-1300-25)
- 1 Valva central 32 x 16 mm (30-1300-32)

completo, compostoda:

- 1 Divaricatore con valve laterali, smusso (30-1301-16)
- 1 Valva centrale 19 x 16 mm (30-1300-19)
- 1 Valva centrale 25 x 16 mm (30-1300-25)
- 1 Valva centrale 32 x 16 mm (30-1300-32)

Wundspreizer, Bauchdeckenhalter

Self-RSeparatainindoresgcRetraon retcetors, Anida abudomitomántiacla,RetractorsSeparadores
 Divaricatori autostatici, Divaricatori addominali abdominales



MAYO-ADAMS
 17,0 cm, 6³/₄"
 070-320-17



COLLIN-BABY
 18,0 cm, 7"
 070-330-18

30 x 44 mm
 070-330-30

Wechselvalven
 Exchangeable blades
 Valvas intergambiabiles
 Valve intercambiabili



23 x 44 mm
 070-330-23



RICARD
 28,0 cm, 11"
 074-310-28



RICARD
 30,0 cm, 12"
 074-312-30

Wundspreizer, Bauchdeckenhalter
Self-Retaining Retractors, Abdominal Retractors
Separadores con retenida automática, Separadores abdominales
Divaricatori autostatici, Divaricatori addominali

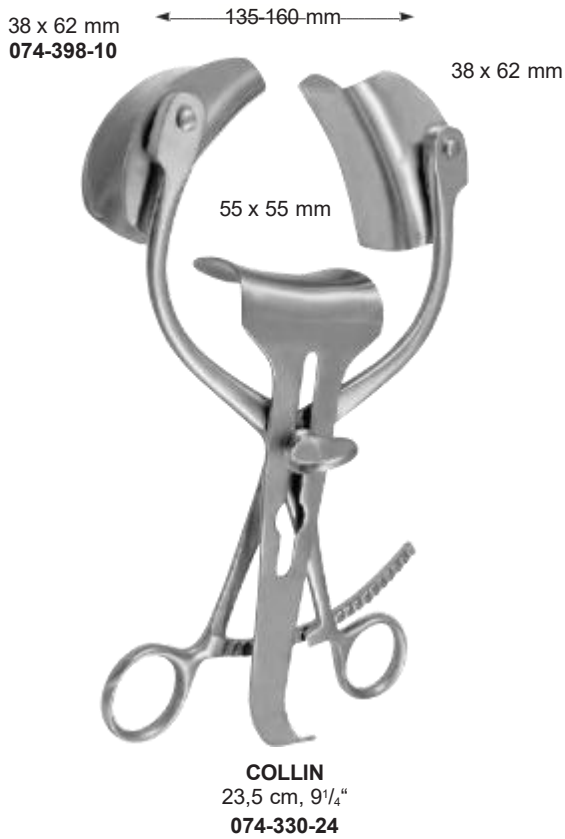

Wundspreizer, Bauchdeckenhalter

Self-RSeparatainindoresg cRetraon retcetors, Anida abudomitomántiacta,RetractorsSeparadores

Divaricatori autostatici, Divaricatori addominali abdominales



38 x 62 mm	074-399-01
40 x 80 mm	074-399-02
60 x 80 mm	074-399-03



50 x 58 mm	074-399-10
60 x 80 mm	074-399-13
72 x 85 mm	074-399-14



074-399-23
60 x 80 mm



074-399-33
60 x 80 mm



58 x 50 mm	074-398-01
80 x 60 mm	074-398-02
85 x 72 mm	074-398-03



62 x 38 mm	074-398-10
80 x 38 mm	074-398-11
100 x 38 mm	074-398-12
80 x 38 mm	074-398-13



COLLIN

55 x 55 mm	074-331-01
55 x 65 mm	074-331-02
55 x 75 mm	074-331-03



RICARD

65 x 50 mm	074-310-01
70 x 55 mm	074-310-02
90 x 80 mm	074-310-03

Bauchdeckenhalter
Abdominal Retractors
Separadores abdominales
Divaricatori ad dominali

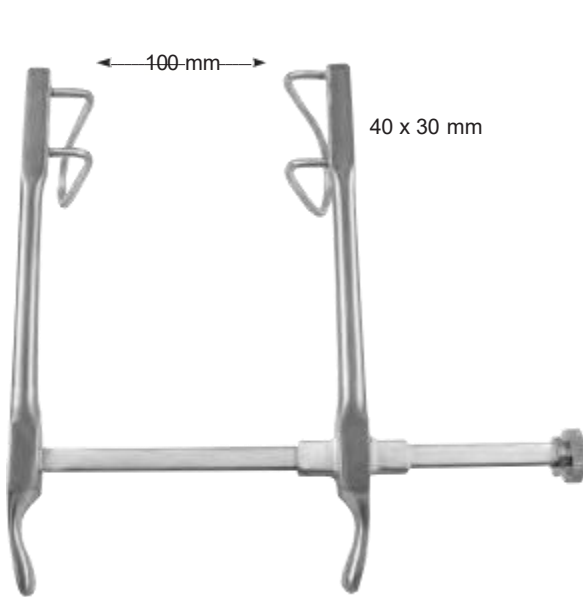

GOSSET
074-400-10

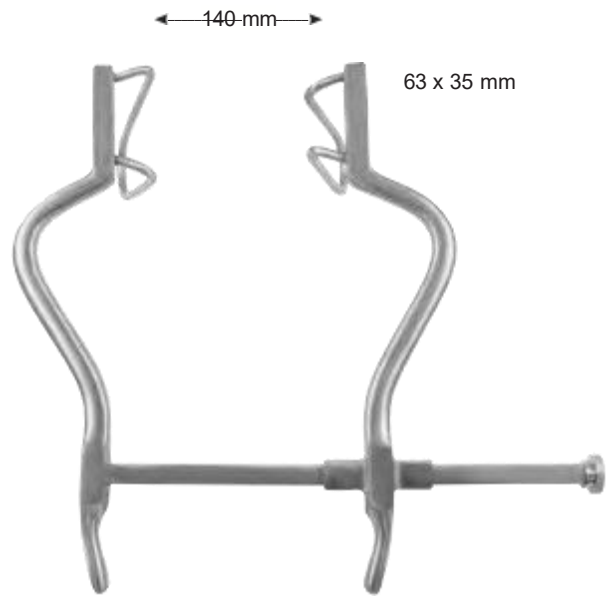

GOSSET
074-412-14

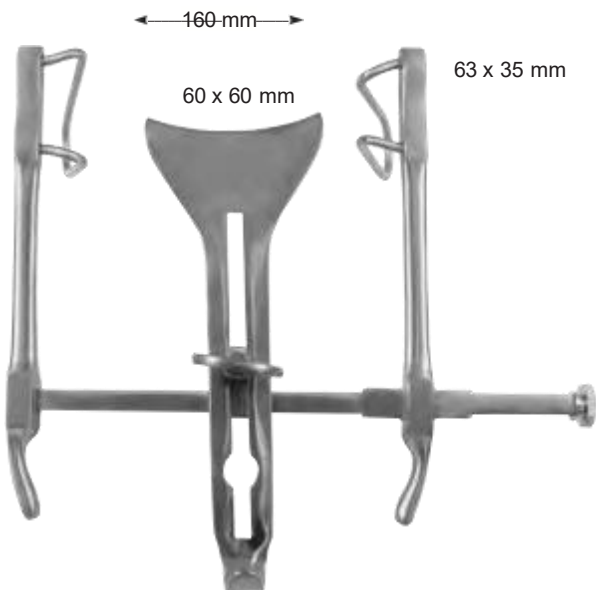

GOSSET
074-414-16

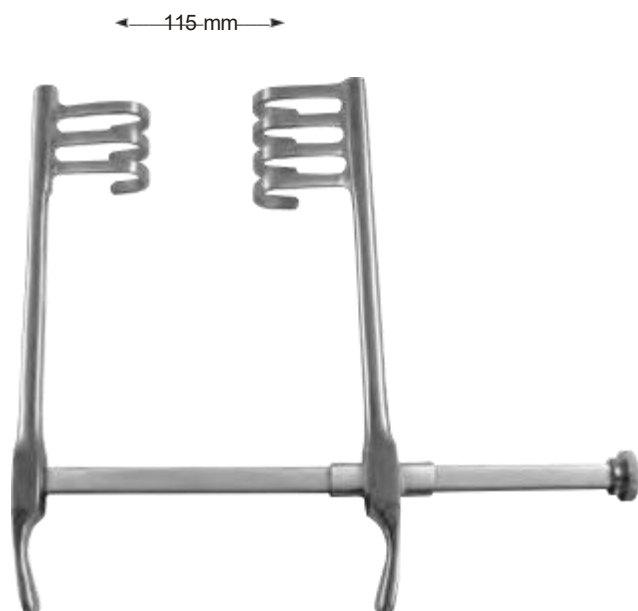

ABADIE
074-450-12

Bauchdeckenhalter
Abdominal Retractors
Separadores abdominales
Divaricatori addominali



BALFOUR
074-764-18

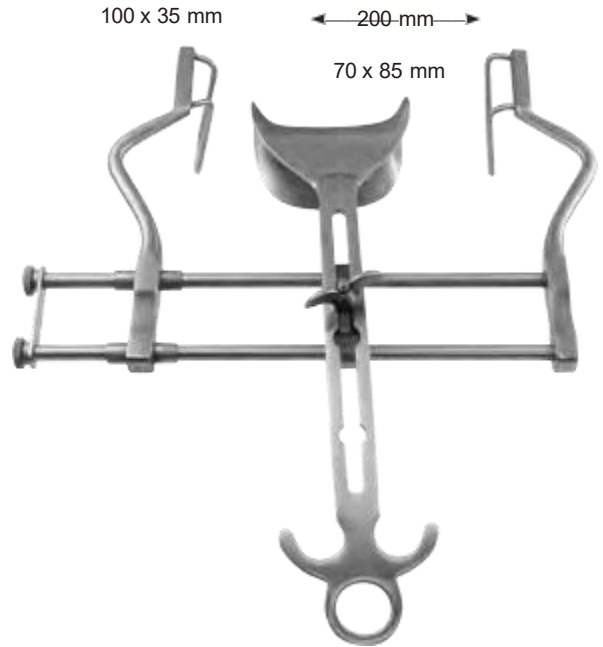

BALFOUR
074-768-20

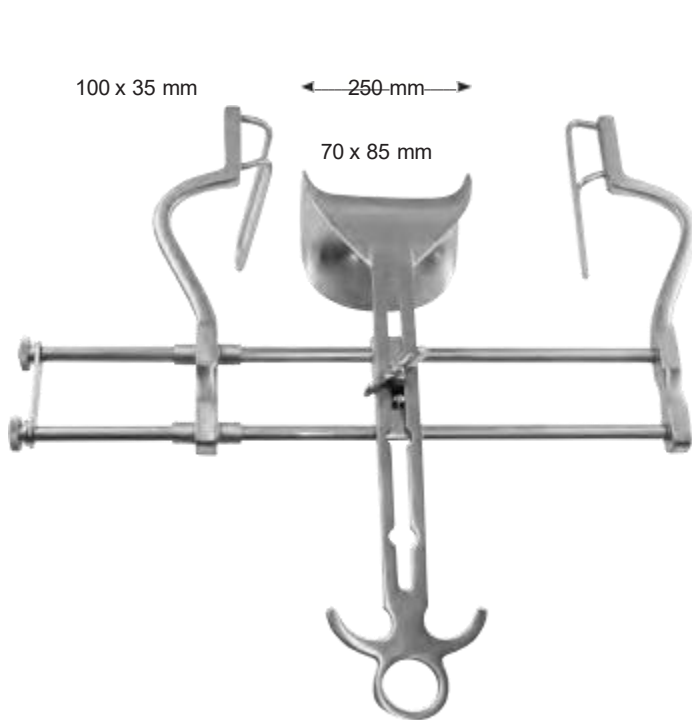

BALFOUR
074-768-25

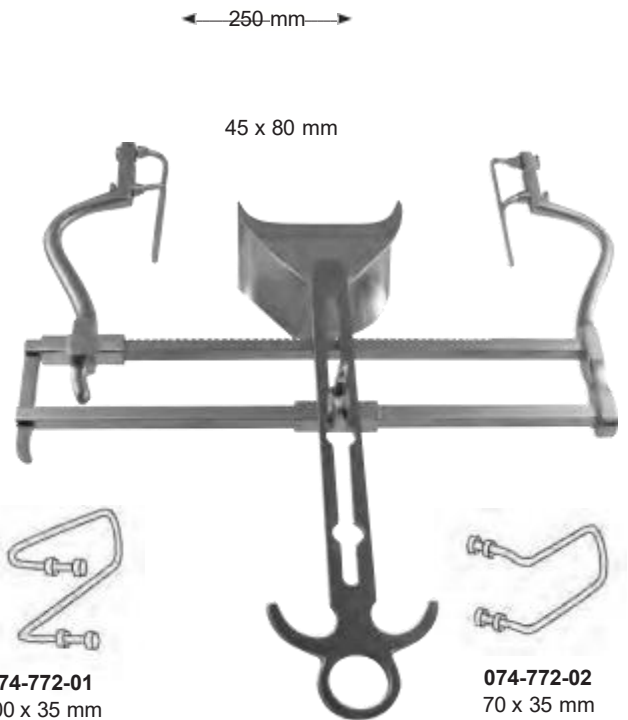

BALFOUR US-TYPE
074-772-25

Bauchdeckenhalter
 Abdominal Retractors
 Separadores abdominales
 Divaricatori addominali



BALFOUR
 100 x 70 mm
 074-799-70

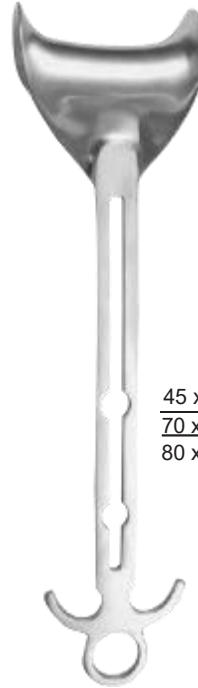

45 x 80 mm **074-798-01**
 70 x 85 mm **074-798-02**
 80 x 90 mm **074-798-03**

BALFOUR

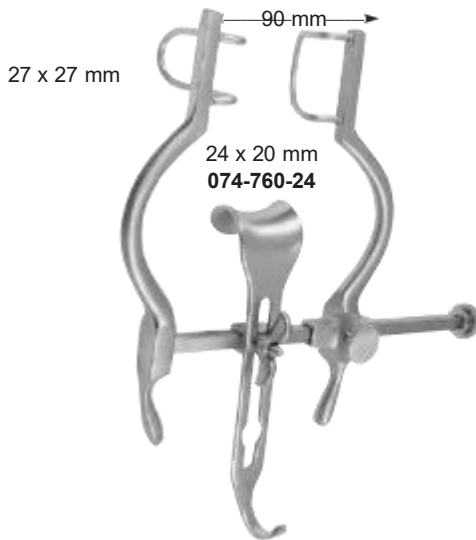

BALFOUR
 074-760-09



Ø 180 mm, 7" **074-850-18**
 Ø 230 mm, 9" **074-850-23**
 Ø 305 mm, 12" **074-850-30**
 455 x 330 mm **074-850-45**

Bauchdeckenhalter
Abdominal Retractors
Separadores abdominales
Divaricatori addominali

geschwärzt, black finish, negra, nera;



074-859-02
51 x 38 mm



074-859-03
70 x 60 mm



074-859-05
114 x 60 mm

geschwärzt, black finish, negra, nera



074-859-06
19 x 76 mm



074-859-07
38 x 102 mm



074-859-08
57 x 89 mm



074-859-09
57 x 114 mm



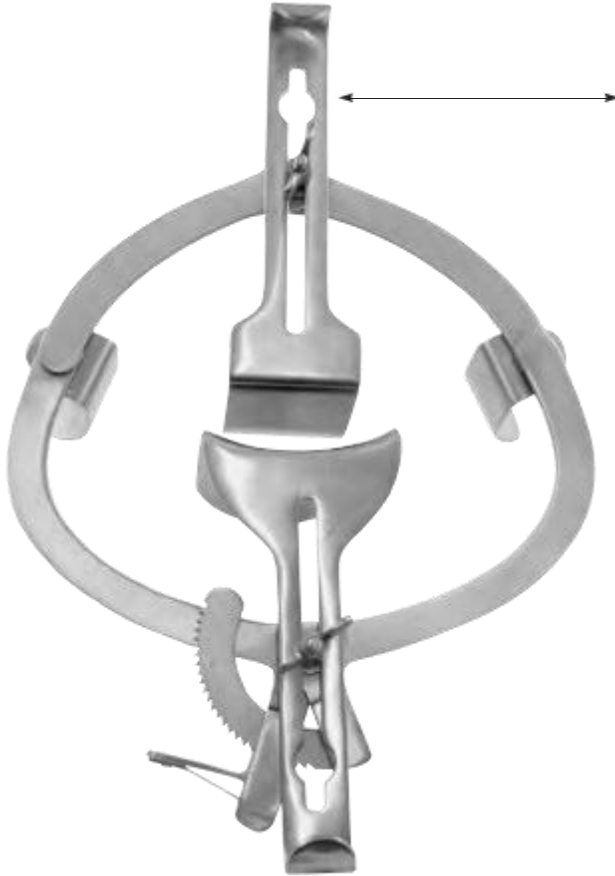

Bauchdeckenhalter
Abdominal Retractors

Separadores abdominales
Divaricatori addominali
Расширители для брюшины

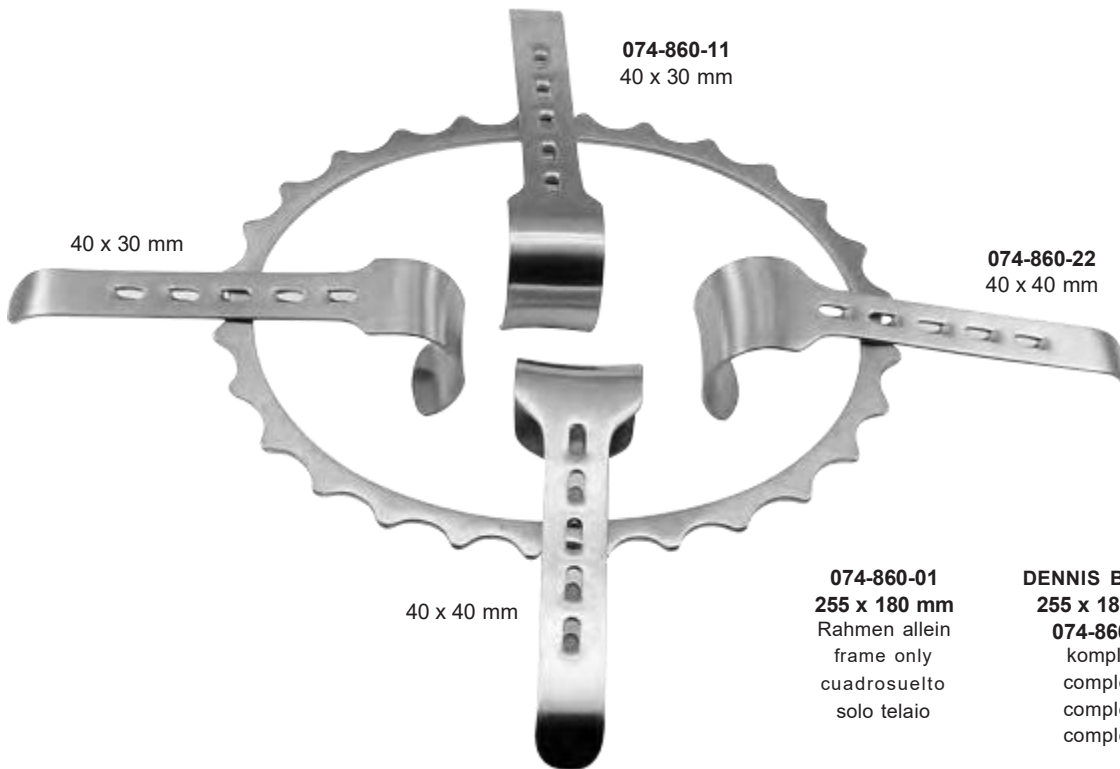

074-860-11
40 x 30 mm

074-860-22
40 x 40 mm

40 x 40 mm

074-860-01
255 x 180 mm
Rahmen allein
frame only
cuadrosuelto
solo telaio

DENNIS BROWN
255 x 180 mm
074-860-00
komplett
complete
completo
completo

074-870-11
80 x 45 mm



074-870-12
110 x 70 mm

074-870-01
Rahmen allein
frame only
cuadrosuelto
solo telaio

O'SULLIVAN-O'CONNOR
074-870-00
komplett
complete
completo
completo

Bauchdeckenhalter
Abdominal Retractors
Separadores abdominales
Divaricatori addominali

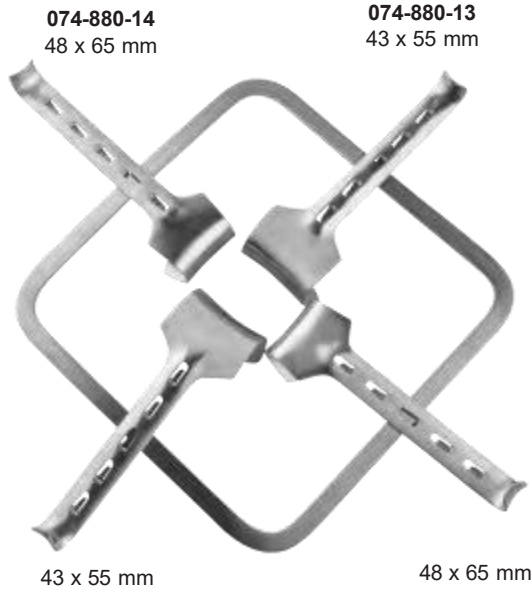

074-880-14
48 x 65 mm

074-880-13
43 x 55 mm

43 x 55 mm

48 x 65 mm

- 074-880-01** 250 x 250 mm
- 074-880-02** 300 x 320 mm
- 074-880-03** 300 x 380 mm
- Rahmen allein
frame only
cuadrosuelto
solo telaio

- KIRSCHNER**
074-880-00
 komplett
 complete
 completo
 completo
 1 x 31-1880-01
 2 x 31-1880-13
 2 x 31-1880-14

- 074-882-01**
 255 x 255 mm
 zusammenlegbarer Rahmen, allein
 folding frame, only
 cuadropiegable, suelto
 telaiopieghevole, solo



- KIRSCHNER**
074-882-00
 komplett
 complete
 completo
 completo
 1 x 31-1882-01
 2 x 31-1882-13
 2 x 31-1882-14



- 43 x 55 mm **074-880-13**
- 48 x 65 mm **074-880-14**
- 80 x 90 mm **074-880-15**
- 90 x 65 mm **074-880-16**
- 98 x 95 mm **074-880-17**

KIRSCHNER



KIRSCHNER
 60 x 82 mm
074-880-11



KIRSCHNER-BALFOUR
 83 x 82 mm
074-880-12



KIRSCHNER
 98 x 51 mm **074-880-20**
 105 x 38 mm **074-880-21**

074-880-14
 48 x 65 mm

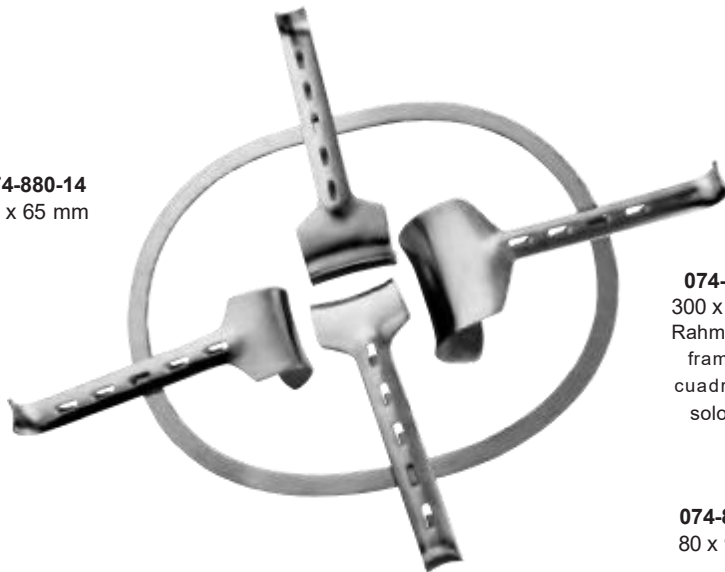

074-890-00
 300 x 240 mm
 Rahmen allein
 frame only
 cuadrosuelto
 solo telaio

074-880-15
 80 x 90 mm

- KIRSCHNER, oval**
074-884-00
 komplett, complete, completo, comple to
 1 x 31-1884-01
 3 x 31-1884-14
 1 x 31-1884-15
 1 x 31-1884-20
 1 x 31-1884-21

Bauchdeckenhalter
Abdominal Retractors
Separadores abdominales
Divaricatori addominali

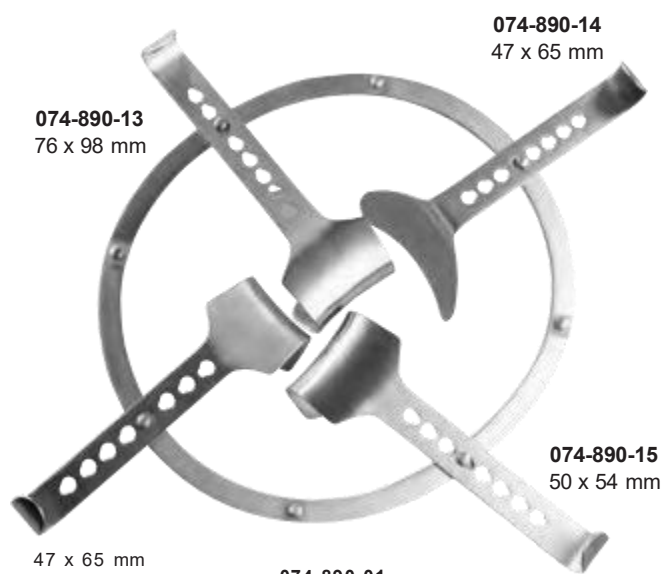

47 x 65 mm

074-890-01
 275 x 250 mm
 Rahmen allein
 frame only
 cuadrosuelto
 solo telaio



074-890-11
 98 x 52 mm

074-890-12
 105 x 35 mm

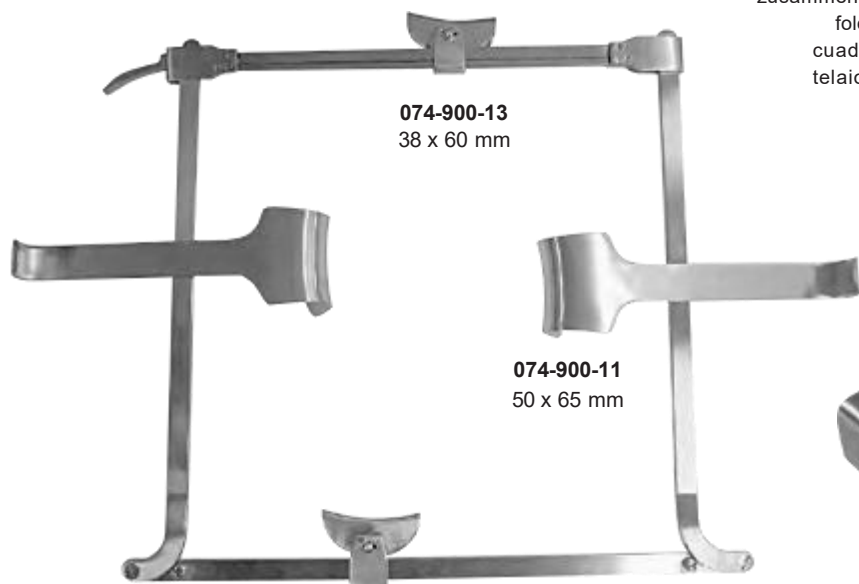

074-900-13
 38 x 60 mm

074-900-11
 50 x 65 mm

074-900-01
 300 x 300 mm
 zusammenlegbarer Rahmen, allein
 folding frame, only
 cuadropiegable, suelto
 telaiopieghevole, solo



38 x 60 mm **074-900-13**
 45 x 80 mm **074-900-14**



50 x 65 mm **074-900-11**
 60 x 85 mm **074-900-12**

FRANZ
074-900-00
 komplett
 complete
 completo
 completo
 1 x 31-1900-01
 2 x 31-1900-11
 2 x 31-1900-13

Bauchdeckenhalter
Abdominal Retractors
Separadores abdominales
Divaricatori addominali

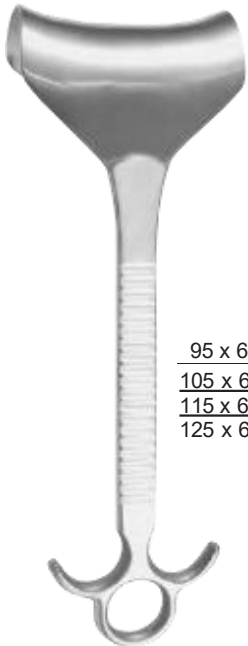

95 x 60 mm **074-910-11**
105 x 65 mm **074-910-12**
115 x 65 mm **074-910-13**
125 x 65 mm **074-910-14**

DOYEN
28,0 cm, 11"

für / for / para / per
074-910-11
074-910-14

Kette mit Gewicht
Chain with weight
Cadena con pesa
Catena con peso



074-915-30
78,5 cm, 31"

53,0 cm, 21"

66,0 cm, 26"

Befestigungsgestell
Mounting frame
Bastidor para la fijación
Telaio di supporto per il fissaggio

ROCHARD
074-920-01

53,0 cm, 21"

66,0 cm, 26"

Befestigungsgestell
Mounting frame
Bastidor para la fijación
Telaio di supporto per il fissaggio

ROCHARD
074-920-02

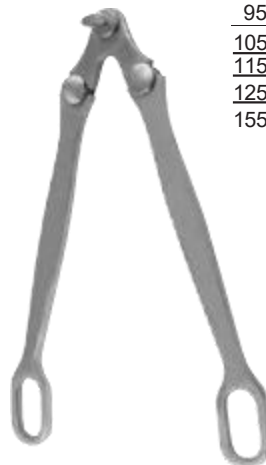

95 x 48 mm **074-920-10**
105 x 48 mm **074-920-12**
115 x 48 mm **074-920-12**
125 x 48 mm **074-920-13**
155 x 48 mm **074-920-16**

ROCHARD
28,0 cm, 11"
074-920-20



ROCHARD
28,0 cm, 11"

Bauchspatel
Abdominal Spatulas
Espátulas abdominales
Spatole addominali



biegsam
 malleable
 maleable
 malleabile

200 x 6 mm **078-210-06**
200 x 12 mm **078-210-12**
200 x 17 mm **078-210-17**
200 x 20 mm **078-210-20**
200 x 25 mm **078-210-25**

RIBBON



biegsam
 malleable
 maleable
 malleabile

330 x 13 mm **078-170-13**
330 x 25 mm **078-170-25**
330 x 32 mm **078-170-32**
330 x 40 mm **078-170-40**
330 x 50 mm **078-170-50**

RIBBON



biegsam
 malleable
 maleable
 malleabile

280 x 25/30 mm **078-200-01**
300 x 37/45 mm **078-200-02**
300 x 40/50 mm **078-200-03**

RIBBON



biegsam
 malleable
 maleable
 malleabile

TUFFIER
 200 x 25/17 mm
078-220-20



REVERDIN
 280 x 45/60 mm
078-230-28

Rippensperrer
Rib Spreaders
Separadores costales
Divaricatori costali

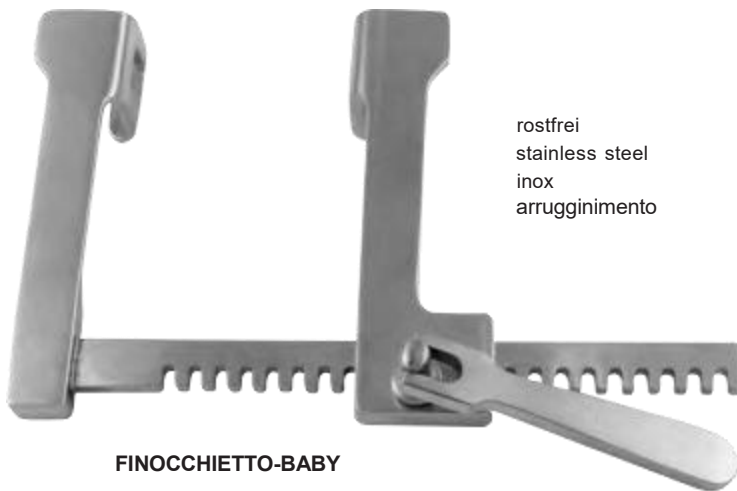

rostfrei
stainless steel
inox
arrugginimento

FINOCCHIETTO-BABY

a	b	c	
18 mm	20 mm	75 mm	140-100-01

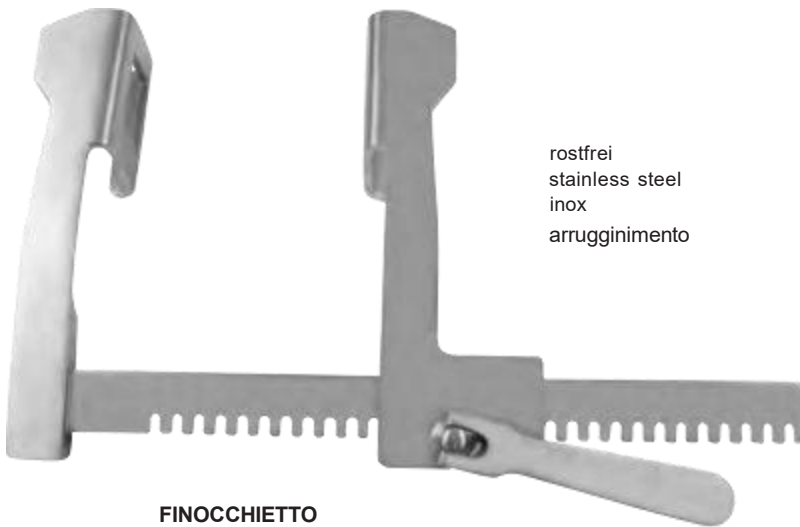

rostfrei
stainless steel
inox
arrugginimento

FINOCCHIETTO

a	b	c	
40 mm	40 mm	165 mm	140-100-02
45 mm	65 mm	200 mm	140-100-03
70 mm	65 mm	250 mm	140-100-04

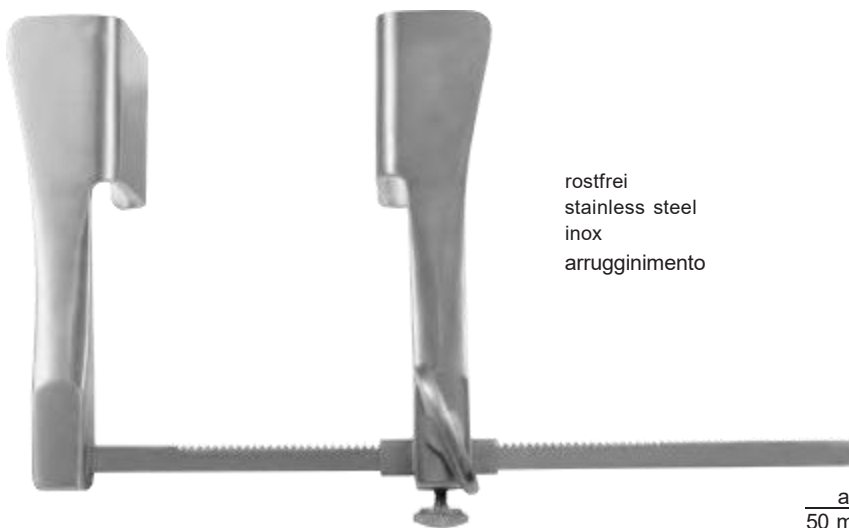

rostfrei
stainless steel
inox
arrugginimento

TUFFIER

a	b	c	
50 mm	45 mm	165 mm	140-150-01

Sonden, Trokare
Probes, Trocars
Sondas, Trócares
Sonde, Trequarti



Sonden
Probes
Sondas
Sonde



	Ø 1,0 mm	Ø 2,0 mm
11,5 cm, 4 1/2"	080-000-11	080-004-11
13,0 cm, 5"	080-000-13	080-004-13
14,5 cm, 5 3/4"	080-000-14	080-004-14
16,0 cm, 6 1/4"	080-000-16	080-004-15
18,0 cm, 7"	080-000-18	080-004-18
20,0 cm, 8"	080-000-20	080-004-20

Ø 2,0 mm



11,5 cm, 4 1/2"	080-013-11
13,0 cm, 5"	080-013-13
14,5 cm, 5 3/4"	080-013-14
16,0 cm, 6 1/4"	080-013-16
18,0 cm, 7"	080-013-18
20,0 cm, 8"	080-013-20

Ø 1,0 mm



Silber
Silver
Plata
Argento

STACKE
10,5 cm, 4 1/8"
080-033-10



Myrtenblattsonden
Myrtle leaf probes
Sondas para mirto
Sonde a foglia di mirto

11,5 cm, 4 1/2"	080-027-11
13,0 cm, 5"	080-027-13
14,5 cm, 5 3/4"	080-027-14
16,0 cm, 6 1/4"	080-027-16
18,0 cm, 7"	080-027-18
20,0 cm, 8"	080-027-20



NÉLATON
16,0 cm, 6 1/4"
080-120-16



DOYEN
14,5 cm, 5 3/4"
080-117-14



BRODIE
20,0 cm, 8"
080-126-20

Ø 3,5 mm

Ø 3,5 mm



11,5 cm, 4 1/2" **080-110-11**
 13,0 cm, 5" **080-110-13**
 14,5 cm, 5 3/4" **080-110-14**
 16,0 cm, 6 1/4" **080-110-16**
 18,0 cm, 7" **080-110-18**
 20,0 cm, 8" **080-110-20**

Ø 3,3 mm



13,0 cm, 5" **080-122-13**
 14,5 cm, 5 3/4" **080-122-14**
 16,0 cm, 6 1/4" **080-122-16**
 18,0 cm, 7" **080-122-18**



LOCKHART-MUMMERY
 16,5 cm, 6 1/2"
080-130-01



LOCKHART-MUMMERY
 16,5 cm, 6 1/2"
080-130-02



LOCKHART-MUMMERY
 16,5 cm, 6 1/2"
080-130-03



LOCKHART-MUMMERY
 16,5 cm, 6 1/2"
080-130-04

Watteträger
 Cotton Applicators
 Porta-algodones
 Porta-cotone



FEIN
 28,0 cm, 11"
 080-264-28



UKERMANN
 16,0 cm, 6 1/4"
 080-260-16



JOBSON-HORNE
 18,0 cm, 7"
 080-262-18



12,0 cm, 4 3/4" 080-271-12 Ø 0,9 mm
14,0 cm, 5 3/4" 080-271-14 Ø 0,9 mm
16,5 cm, 6 1/4" 080-271-16 Ø 1,1 mm
18,0 cm, 7" 080-271-18 Ø 1,2 mm

FARRELL
 (LATHBURY)



12,0 cm, 4 3/4" 080-270-12 Ø 0,9 mm
14,0 cm, 5 3/4" 080-270-14 Ø 0,9 mm
16,5 cm, 6 1/4" 080-270-16 Ø 1,1 mm
18,0 cm, 7" 080-270-18 Ø 1,2 mm

FARRELL

Krampfader-Besteck
Varicose Vein Probe Set
Juego para várices
Astuccio per varici



080-150-01
 Metalletui
 Metal case
 Estuche de metal
 Scatola in metallo
 135 x 100 x 25 mm



Ø 3,0 mm
080-150-03



Ø 6,0 mm
080-150-06



Ø 9,0 mm
080-150-09



Ø 12,0 mm
080-150-12

NABATOFF
080-150-00
 komplett
 complete
 completo
 completo



080-150-21
 Zugseil
 Cable
 Cable
 Fune

080-150-22
 Kunststoff-Sondenspitze
 Plastic probe tip
 Extremidad de sonda de plástico
 Punta in materia plastica

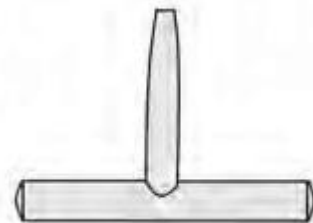

080-150-20
 Handgriff
 Handle
 Mango
 Manico

Trokare
Trocars
Trócares
Trequarti



Ø 3,0 mm	084-110-30
Ø 3,5 mm	084-110-35
Ø 4,0 mm	084-110-40
Ø 4,5 mm	084-110-45
Ø 5,0 mm	084-110-50
Ø 5,5 mm	084-110-55
Ø 6,0 mm	084-110-60

STANDARD
11,0 cm, 4³/₈"



Ø 3,0 mm	084-112-30
Ø 3,5 mm	084-112-35
Ø 4,0 mm	084-112-40
Ø 4,5 mm	084-112-45
Ø 5,0 mm	084-112-50
Ø 5,5 mm	084-112-55
Ø 6,0 mm	084-112-60

STANDARD
12,0 cm, 4³/₄"



Ø 3,0 mm	084-114-30
Ø 3,5 mm	084-114-35
Ø 4,0 mm	084-114-40
Ø 4,5 mm	084-114-45
Ø 5,0 mm	084-114-50
Ø 5,5 mm	084-114-55
Ø 6,0 mm	084-114-60

STANDARD
12,0 cm, 4³/₄"



Ø 7,3 mm	084-118-07
Ø 8,7 mm	084-118-09
Ø 12,0 mm	084-118-12

HURWITZ



UNIVERSAL
084-100-03

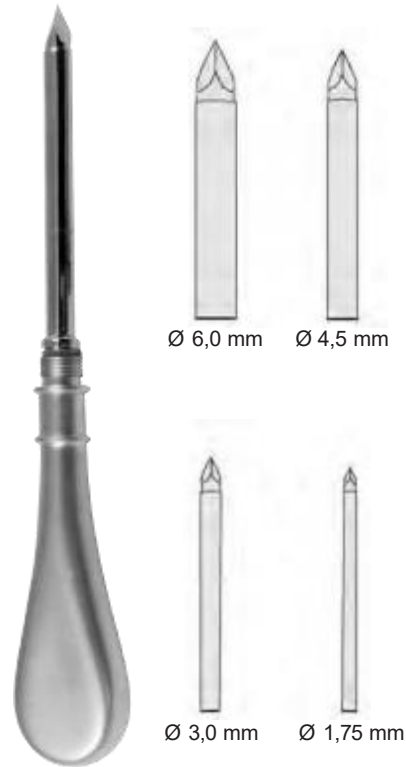

UNIVERSAL
084-100-04

140-mm

LANDAU
Ø 2,0 mm
084-160-16



LANDAU
Ø 2,0 mm
084-161-16



DAVIDSON
Ø 6,0 mm
084-164-18



BUELAU
Ø 8,0 mm
084-124-24

Trokare
Trocars
Trócares
Trequarti



Ø 6,0 mm **084-128-06**
Ø 8,0 mm **084-128-08**

CAMPBELL
16,0 cm, 6 1/4"

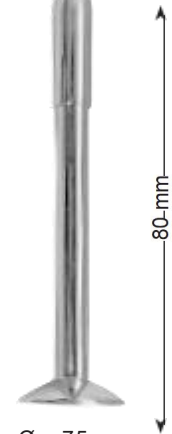

Ø 7,5 mm
Ø 9,0 mm **084-120-01**
Ø 10,5 mm **084-120-02**
Ø 12,0 mm **084-120-03**
084-120-04

NELSON
21,0 cm, 8 1/2"



Ø 4,0 mm **084-140-01**
Ø 4,6 mm **084-140-02**
Ø 5,5 mm **084-140-03**
Ø 6,5 mm **084-140-04**

OCHSNER
14,0 cm, 5 1/2"

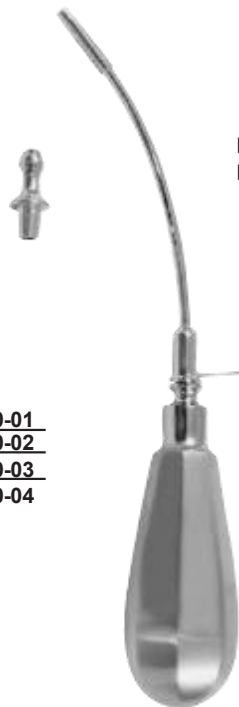

Record Konus
Record cone

Ø 3,0 mm **084-180-30**
Ø 4,0 mm **084-180-40**
Ø 5,0 mm **084-180-50**

PIERCE
16,0 cm, 6 1/4"



Ø 2,25 mm

COAKLEY
14,0 cm, 5 1/4"
084-190-14

Ø 4,0 mm



KRAUSE
16,0 cm, 6 1/4"

- Ø 3,0 mm **084-184-30**
- Ø 4,0 mm **084-184-40**
- Ø 5,0 mm **084-184-50**
- Ø 5,5 mm **084-184-55**

LICHTWITZ
Kieferhöhlentrocars
Antrum trocars
Trócares para el seno maxilar
Trequarti per puntura del seno mascellare

Ø 1,8 mm



LICHTWITZ
20,0 cm, 8"
084-170-00

Trokare, Saugrohre
Trocars, Suction Tubes
Trócares, Tubos para aspiración
Trequarti, Tubi aspirazione



LICHTWITZ
11,0 cm, 4 1/2"
084-172-00



DOUGLAS
Ø 3,0 mm
084-175-00



POOLE
22,0 cm, 8 5/8"
Ø 6,0 mm **085-020-06**
Ø 10,0 mm **085-020-10**



POOLE
22,0 cm, 8 5/8"
Ø 6,0 mm **085-021-06**
Ø 8,0 mm **085-021-08**

Saugrohre
Suction Tubes
Tubos para aspiración
Tubi aspirazione

auswechselbare Spitze
interchangeable tip
punta intercambiabile
tipintercambiabile



COUPLAND
17,0 cm, 6³/₄"
085-010-17



Ø 3,5 mm
085-010-35



YANKAUER
27,0 cm, 10⁵/₈"
085-000-27



085-024-00
Olive allein
Olive only
Oliva suelto
Olivo solo



DE BAKERY
27,0 cm, 10⁵/₈"
085-008-27



ANTHONY
26,0 cm, 10¹/₄"
085-007-26



ANDREWS-PYNCHON
24,0 cm, 9¹/₂"
085-006-24



COOLEY
35,0 cm, 13³/₄"
Ø 8,0 mm
085-024-02



COOLEY
30,0 cm, 11³/₄"
Ø 7,0 mm
085-024-03



COOLEY
31,0 cm, 11³/₄"
Ø 10,0 mm
085-024-04



COOLEY
33,0 cm, 13"
Ø 8,0 mm
085-024-01



BYRD
20,0 cm, 8"
Ø 1,5 mm **085-012-15**
Ø 2,5 mm **085-012-25**
Ø 3,5 mm **085-012-35**

Ø 4,0 mm



ADSON
21,0 cm, 8 1/4"
085-050-21



MAGILL
17,5 cm, 6 5/8"
Ø 1,0 mm **085-060-01**
Ø 2,0 mm **085-060-02**
Ø 3,0 mm **085-060-03**
Ø 4,0 mm **085-060-04**



FRAZIER
19,0 cm, 7 1/2"

Charr. 6 **085-030-06**
Charr. 8 **085-030-08**
Charr. 10 **085-030-10**
Charr. 12 **085-030-12**



FERGUSON
18,0 cm, 7"

Charr. 6 **085-033-06**
Charr. 8 **085-033-08**
Charr. 10 **085-033-10**
Charr. 12 **085-033-12**

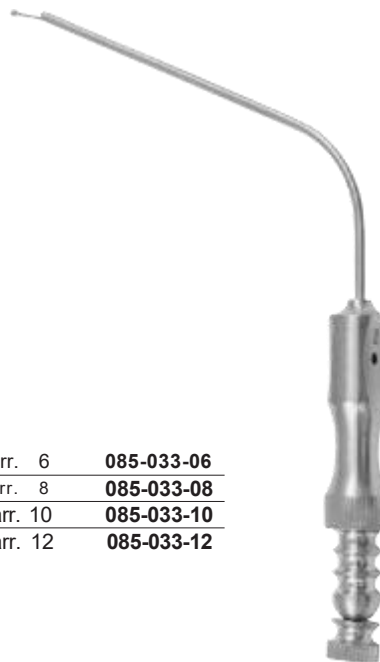

POPPE
13,0 cm, 5"

Charr. 6 **085-034-06**
Charr. 8 **085-034-08**
Charr. 10 **085-034-10**
Charr. 12 **085-034-12**

**Spezialkanülen
Special Needles
Agujas especiales
Aghi speciali**



LUER-LOCK

Packung zu 12 Stück
Package of 12 pcs.
Cajecita de 12 pzs.
Confezione da 12 pezzi

Ø 0,90 x 38 mm	086-000-01
Ø 0,80 x 32 mm	086-000-02
Ø 0,70 x 32 mm	086-000-03
Ø 0,65 x 28 mm	086-000-04
Ø 0,60 x 25 mm	086-000-05
Ø 0,50 x 23 mm	086-000-06
Ø 0,45 x 20 mm	086-000-07



IOWA
14,0 cm, 5 1/4"
086-150-14

Ø 1,0 x 185 mm

086-150-01
Nadel
Needle
Aguja
Aghi



MOCK
6,0 cm, 2 3/8"
086-200-06



SCHMID
15,0 cm, 6"



Ø 3,0 mm
086-140-03



Ø 4,0 mm
086-140-04



Ø 5,0 mm
086-140-05



Ø 6,0 mm
086-140-06

Gefäßspülkanülen, biegsam
Vascular irrigation cannulae, malleable
Cánulas vasculares para irrigación, maleables
Aghi vascolari per irrigazione, malleabili

Saugrohre
Suction Tubes
Tubos para aspiración
Tubi aspirazione



Ø 1,20 x 80 mm 086-210-12
Ø 1,50 x 80 mm 086-210-15



Ø 2,00 x 100 mm 086-180-10
Ø 2,00 x 120 mm 086-180-12
Ø 2,00 x 150 mm 086-180-15

VERESS

Kanülen zur Sternalpunktion
Sternum puncture needles
Agujas para lapunción delesternón
Aghi per puntura dello sterno



KLIMA-ROSSEGER
Ø 1,60 x 40 mm
086-060-16

Kanülen zur Lumbalpunktion
Lumbar puncture needles
Agujas para punción lumbar
Aghi per punture lombari



Ø 0,8 x 70/80/90/100/120 mm 086-130-01
Ø 1,0 x 70/80/90/100/120 mm 086-130-02
Ø 1,2 x 70/80/90/100/120 mm 086-130-03
Ø 1,4 x 70/80/90/100/120 mm 086-130-04
Ø 1,6 x 70/80/90/100/120 mm 086-130-05
Ø 1,8 x 70/80/90/100/120 mm 086-130-06
Ø 2,0 x 70/80/90/100/120 mm 086-130-07

BIER

Spezialkanülen
Special Needles
Agujas especiales
Aghi speciali

Kanülen zur Lumbalpunktion
 Lumbar puncture needles
 Agujas para punción lumbar
 Aghi per punture lombari



QUINKE

- Ø 1,20 x 76 mm 086-120-01
- Ø 1,20 x 89 mm 086-120-02
- Ø 1,00 x 76 mm 086-120-03
- Ø 1,00 x 89 mm 086-120-04
- Ø 0,70 x 76 mm 086-120-05
- Ø 0,70 x 50 mm 086-120-06
- Ø 0,70 x 89 mm 086-120-07

Kanülen zur Lumbalpunktion
 Lumbar puncture needles
 Agujas para punción lumbar
 Aghi per punture lombari



TUHOJ



- Ø 1,20 x 76 mm 086-090-12
- Ø 1,40 x 76 mm 086-090-14
- Ø 1,60 x 76 mm 086-090-16

Kanülen zur Leberblindpunktion
 Liver blind puncture needles
 Agujas para punción ciega del hígado
 Aghi per punture cieca del fegato



MENGHINI

- Ø 1,00 x 35 mm 086-115-01
- Ø 1,00 x 70 mm 086-115-02
- Ø 1,20 x 70 mm 086-115-03
- Ø 1,20 x 100 mm 086-115-04
- Ø 1,40 x 70 mm 086-115-05
- Ø 1,40 x 100 mm 086-115-06
- Ø 1,60 x 70 mm 086-115-07
- Ø 1,60 x 100 mm 086-115-08

Kanülen zur gezielten Leberpunktion
 Needles for controlled liver puncture
 Agujas para lapunción del hígado bajo el control laparoscópico
 Aghi per la punture controllata del fegato



MENGHINI

- Ø 1,40 x 168 mm 086-117-14
- Ø 1,80 x 168 mm 086-117-18

Trokare für Kanülen
 Trocars for needles
 Trocares para agujas
 Tre quarti oer aghi



- Ø 1,40 x 168 mm 086-230-14
- Ø 1,80 x 168 mm 086-230-18

Spritzen, Ersatzzylinder
 Syringes, Spare barrel
 Jeringas, Cilindro de requesto
 Siringhe, Cilindro di ricambio



1 ml	087-051-01
2 ml	087-051-02
5 ml	087-051-05
10 ml	087-051-10
20 ml	087-051-20
50 ml	087-051-50



1 ml	087-001-01
2 ml	087-001-02
5 ml	087-001-05
10 ml	087-001-10
20 ml	087-001-20
50 ml	087-001-50



1 ml	087-061-01
2 ml	087-061-02



LUER

1 ml	087-050-01
2 ml	087-050-02
5 ml	087-050-05
10 ml	087-050-10
20 ml	087-050-20
50 ml	087-050-50



LUER-LOCK

1 ml	087-000-01
2 ml	087-000-02
5 ml	087-000-05
10 ml	087-000-10
20 ml	087-000-20
50 ml	087-000-50

LUER-LOCK

2 ml	087-055-02
5 ml	087-055-05
10 ml	087-055-10

INSULIN LUER



1 ml	087-060-01
2 ml	087-060-02

Spritzen
Syringes
Jeringas
Siringhe



50 ml **087-071-05**
100 ml **087-071-10**
150 ml **087-071-15**
200 ml **087-071-20**



10 ml **087-081-10**
20 ml **087-081-20**
30 ml **087-081-30**
50 ml **087-081-50**



50 ml **087-070-05**
100 ml **087-070-10**
150 ml **087-070-15**
200 ml **087-070-20**

Verbindungsstücke, Hähne
Connecting Pieces, Stopcocks
Piezas de conexión, Llaves
Raccordi, Rubinetti

Zwischenstück, LUER-LOCK weiblich
 Connecting piece, LUER-LOCK female
 Pieza deconexión, LUER-LOCK hembra
 Raccordo, LUER-LOCK femmina



087-911-00

Zwischenstück, LUER-LOCK männlich
 Connecting piece, LUER-LOCK male
 Pieza deconexión, LUER-LOCK masculino
 Raccordo, LUER-LOCK maschio



087-930-02

Zwischenstück, LUER-LOCK männlich
 Connecting piece, LUER-LOCK male
 Pieza deconexión, LUER-LOCK masculino
 Raccordo, LUER-LOCK maschio

Ø 6 mm Ø 8 mm



087-912-06 087-912-08

Zwischenstück, LUER-LOCK weiblich
 Connecting piece, LUER-LOCK female
 Pieza deconexión, LUER-LOCK hembra
 Raccordo, LUER-LOCK femmina



087-913-00

Zwischenstück, LUER-LOCK männlich
 Connecting piece, LUER-LOCK male
 Pieza deconexión, LUER-LOCK masculino
 Raccordo, LUER-LOCK maschio



087-935-00

Durchflußhahn, LL männl. – LL weibl.
 Stopcock, LL male – LL female
 Llave, LL masculino – LL hembra
 Rubinetto, LL maschio – LL femmina



087-939-00

Durchflußhahn, LL weiblich
 Stopcock, LL female
 Llave, LL hembra
 Rubinetto, LL femmina



087-920-00

Dreiweghahn, 1 LL männl. – 2 LL weibl.
 Three-way-stopcock, 1 LL male – 2 LL female
 Llave de 3 vías, 1 LL masculino – 2 LL hembra
 Rubinetto a tre vie, 1 LL maschio – 2 LL femmina



087-922-00

Dreiweghahn, 3 LL weiblich
 Three-way-stopcock, 3 LL female
 Llave de 3 vías, 3 LL hembra
 Rubinetto a tre vie, 3 LL femmina



087-926-00

Galle, Leber, Niere, Blase, Urologie
Gall, Liver, Kidney, Bladder, Urology
Bilis, Hígado, Riñon, Vejiga, Urología
Bile, Fegato, Rene, Vescica, Urologia

Nierensteinzangen, Gallensteinzangen
 Kidney Stone Forceps, Gall Stone Forceps
 Pinzas para los cálculos renales, Pinzas para los cálculos biliares
 Pinze per calcoli renali, Pinze per calcoli biliari



RANDALL

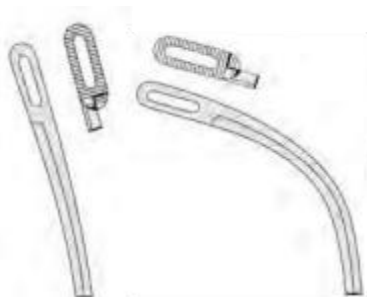

23,0 cm, 9"
158-001-01

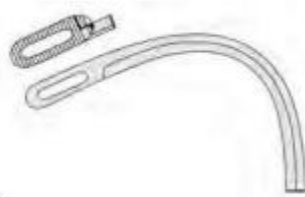

22,0 cm, 8⁵/₈"
158-001-02



22,0 cm, 8⁵/₈"
158-001-03

22,0 cm, 8⁵/₈"
158-001-04

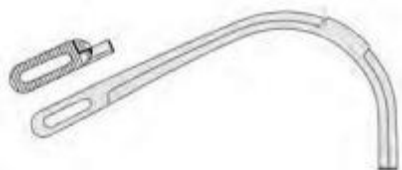

19,0 cm, 7¹/₂"
158-001-05

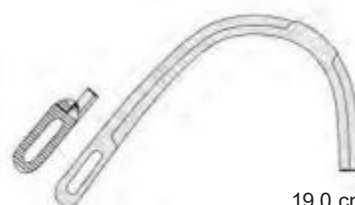

19,0 cm, 7¹/₂"
158-001-06



DESJARDINS
 23,0 cm, 9"



154-001-01



154-001-02



MIXTER
 22,0 cm, 8⁵/₈"
154-021-22



MAYO BLAKE
 20,0 cm, 8"
154-008-20

20,0 cm, 8"
154-009-20

Gallensteinzangen
Gall Stone Forceps
Pinzas para los cálculos biliares
Pinze per calcoli biliari



BLAKE
20,0 cm, 8"
154-006-20



20,0 cm, 8"
154-005-20



TURNER-WARWICK
18,0 cm, 7"

154-031-01

154-031-03



CZERNY
24,5 cm, 9⁵/₈"
154-039-24

Gallengangsonden, Gallengang Dilatatore
 Gall Duct Probes, Common Bile Duct Dilators
 Sonas p. el conducto biliar, Dilatadores para el conducto biliar
 Dilatatori per condotti biliari, Dilatatori per coledoco



MAYO
 32,0 cm, 12½"
 154-078-32



OCHSNER
 35,0 cm, 13¾"
 154-082-35



DESJARDINS
 28,0 cm, 11"



MOORE
 30,0 cm, 12"
 154-084-30

Gallenblasenlöffel
 Gall bladder scoope
 Cuccharilla para lavesicula biliar
 Cucchiaio per colecisti



DESJARDINS
 28,0 cm, 11"

Gallensteinlöffel
 Gall Stone Scoops
 Cucharillas para los cálculos biliares
 Cucchiai per calcoli biliari



LUER-KÖRTE
 24,0 cm, 9½"

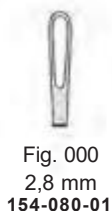

Fig. 000
 2,8 mm
 154-080-01



Fig. 00
 3,4 mm
 154-080-02



Fig. 2
 6,7 mm
 154-080-05



Fig. 3
 8,0 mm
 154-080-06



Fig. 0
 4,3 mm
 154-080-03



Fig. 1
 5,5 mm
 154-080-04



Fig. 4
 11,0 mm
 154-080-07



Fig. 5
 15,0 mm
 154-080-08



FERGUSSON
 21,5 cm, 8½"
 154-070-01



MAYO
 27,0 cm, 10⅝"
 154-072-01



MAYO
 27,0 cm, 10⅝"



154-074-01



154-074-02



MOYNIHAN
 34,0 cm, 13⅜"
 154-076-34

Gallengang Dilatatoren
Common Bile Duct Dilators
Dilatadores para el conducto biliar
Dilatatori per coledoco

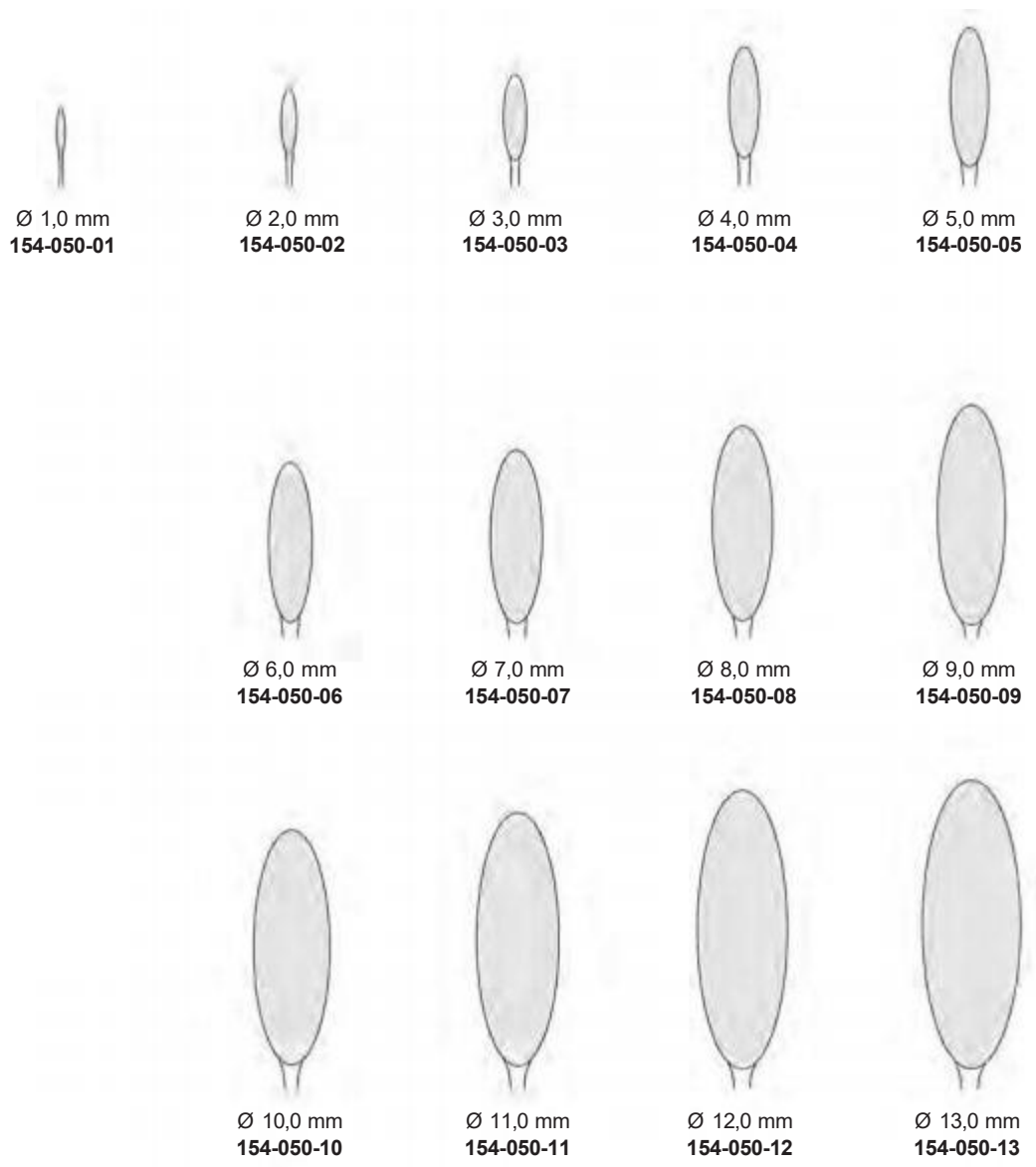

Ø 1,0 mm
154-050-01

Ø 2,0 mm
154-050-02

Ø 3,0 mm
154-050-03

Ø 4,0 mm
154-050-04

Ø 5,0 mm
154-050-05

Ø 6,0 mm
154-050-06

Ø 7,0 mm
154-050-07

Ø 8,0 mm
154-050-08

Ø 9,0 mm
154-050-09

Ø 10,0 mm
154-050-10

Ø 11,0 mm
154-050-11

Ø 12,0 mm
154-050-12

Ø 13,0 mm
154-050-13



BAKES
30,0 cm, 11³/₄“

**Blasenwundpreizer
Bladder Retractors
Deparadores para la vejiga
Divaricatori vescicali**



**THOMSON-WALKER
170-182-00**

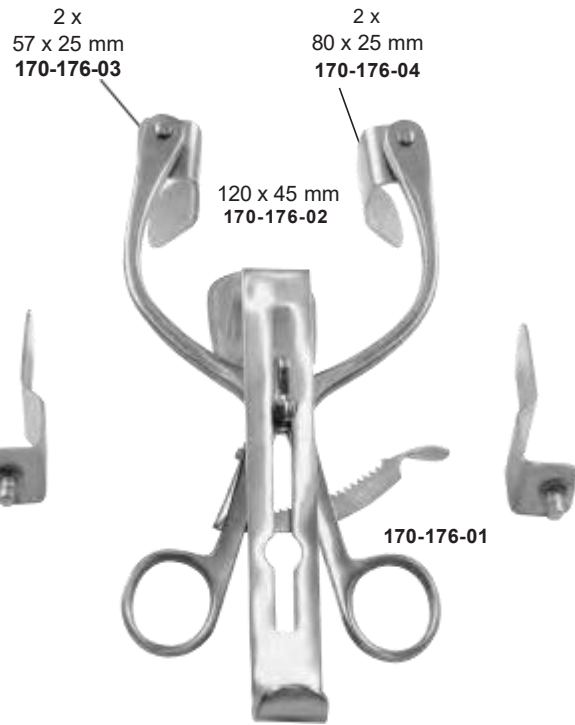

**MILLIN
170-176-00**

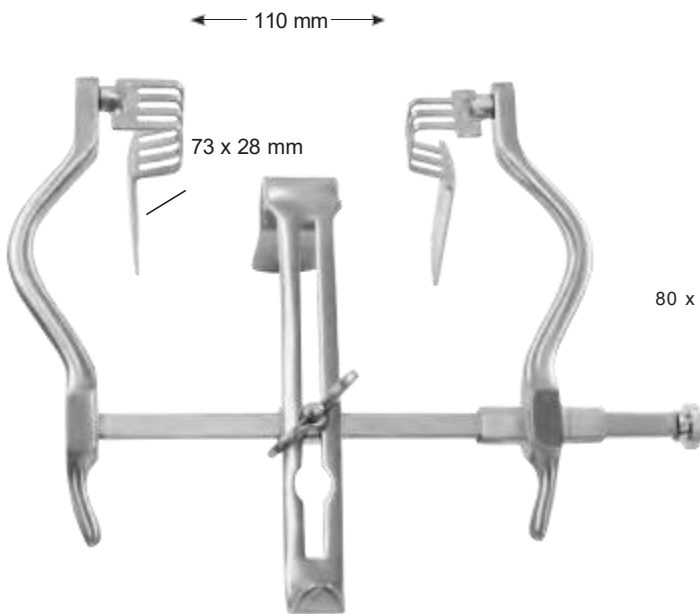

**JUDD-MASSON
170-172-00**

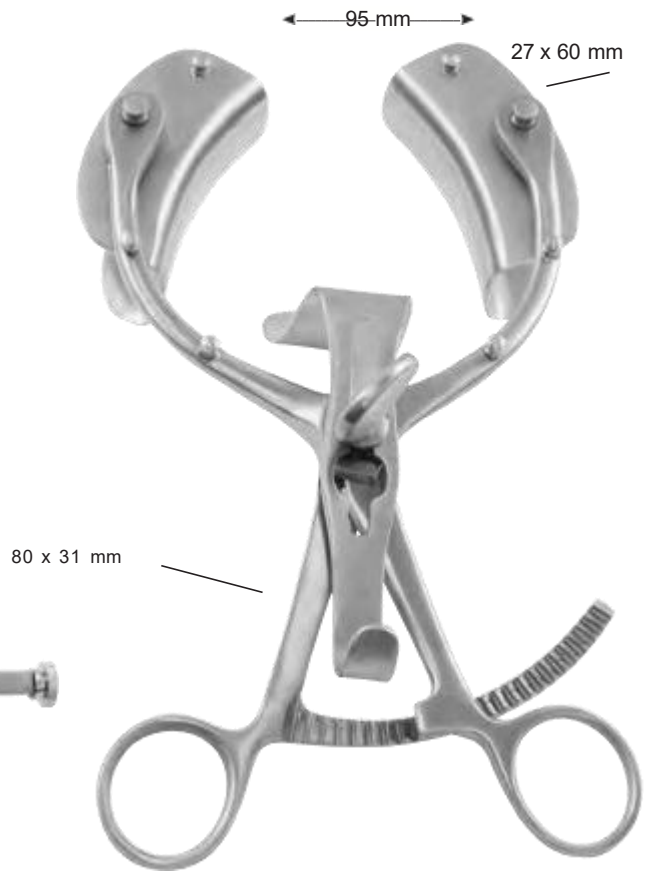

**LEGUEU
170-160-00**

Instrumente für Prostatektomie
Prostatectomy Instruments
Instrumentos para la prostatectomía
Strumenti per operazioni della prostata



MILLIN
 23,0 cm, 9"
 170-073-23

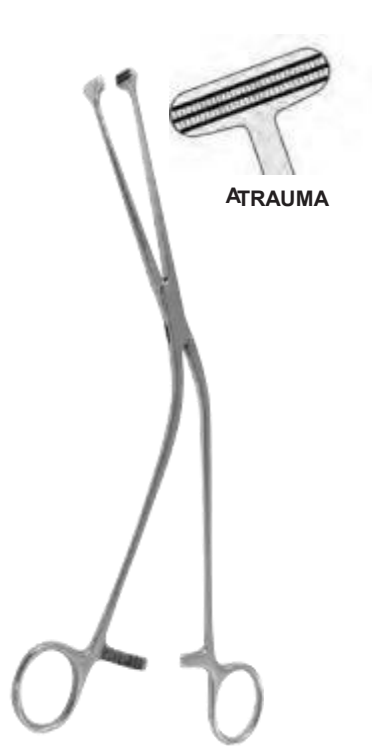

ATRAUMA

MILLIN
 24,0 cm, 9½"
 170-071-24



MILLIN
 24,0 cm, 9½"
 170-077-24



MILLIN
 23,0 cm, 9"
 170-075-23



MILLIN
 28,5 cm, 11¼"
 170-150-24



20,0 cm, 8" **170-080-20**
 28,0 cm, 11" **170-080-28**

MATHIEU

Prostatahaken, Blasenspatel
Prostatic Retractors, Bladder Retractor
Separadores para la prostata, Separadores vesicales
Retrattori prostatici, Divaricatori vescicali



YOUNG
21,0 cm, 8¹/₄"
170-230-21



YOUNG
22,0 cm, 8⁵/₈"
170-236-22



YOUNG
21,0 cm, 8¹/₄"
170-238-21



YOUNG
22,0 cm, 8⁵/₈"
170-240-22



90 x 35 mm

LEGUEU
26,0 cm, 10¹/₄"
170-250-26



90 x 61 mm

KOCHER
23,5 cm, 9¹/₄"
170-257-23

Katheter, Penisklemmen
Catheters, Penis Clamp
Sondas, Compresor urétral
Cateteri, Serrapene



für Männer
 for men
 para hombres
 per uomini

Char. 18	170-650-08
Char. 10	170-650-10
Char. 12	170-650-12
Char. 14	170-650-14
Char. 16	170-650-16
Char. 18	170-650-18
Char. 20	170-650-20
Char. 22	170-650-22
Char. 24	170-650-24

29,0 cm, 11½"



für Frauen
 for women
 para mujeres
 per donne

Char. 16	170-660-06
Char. 17	170-660-07
Char. 18	170-660-08
Char. 19	170-660-09
Char. 10	170-660-10
Char. 11	170-660-11
Char. 12	170-660-12
Char. 13	170-660-14
Char. 15	170-660-15
Char. 16	170-660-16
Char. 18	170-660-18
Char. 20	170-660-20
Char. 24	170-660-24

16,0 cm, 6¼"



STRAUSS
 11,0 cm, 4⅓"
 170-349-11



STOCKMANN
 8,0 cm, 3¼"
 170-345-08



COMCO

Ø 8,0 mm	170-350-08
Ø 11,0 mm	170-350-11
Ø 13,0 mm	170-350-13
Ø 16,0 mm	170-350-16
Ø 21,0 mm	170-350-21
Ø 26,0 mm	170-350-26
Ø 32,0 mm	170-350-32



RISH SURGICAL

NAME OF TRUST

**Magen, Darm, Mastdarm
Stomach, Intestines, Rectum
Estómago, Intestino, Recto
Stomaco, Intestino, Retto**

Darm- und Gewebefäßzangen
 Intestinal and Tissue Grasping Forceps
 Pinzas intestinales y para tejidos
 Pinze da presa per intestino e tessuti



12,0 cm, 4³/₄" **160-000-12**
 15,0 cm, 6" **160-000-15**

ALLIS-BABY

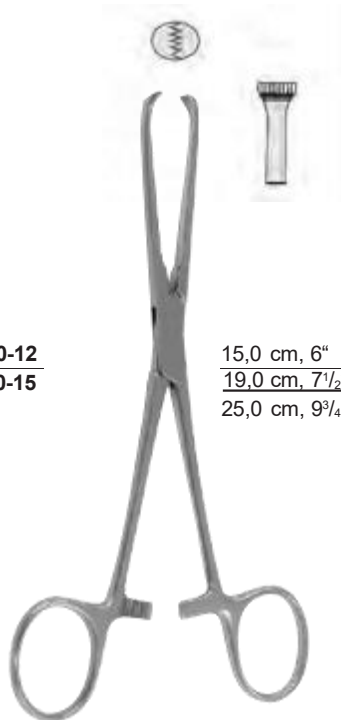

15,0 cm, 6" **160-004-15**
 19,0 cm, 7¹/₂" **160-004-19**
 25,0 cm, 9³/₄" **160-004-25**

ALLIS

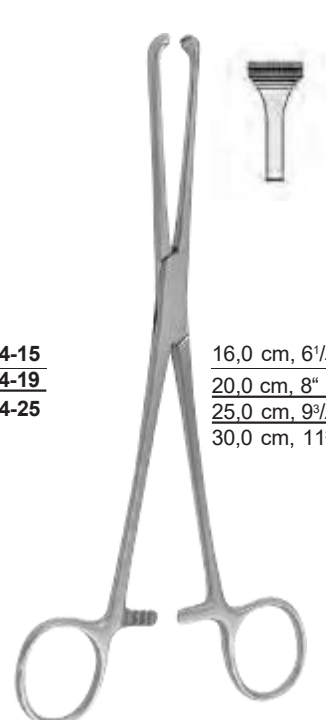

16,0 cm, 6¹/₄" **160-124-16**
 20,0 cm, 8" **160-124-20**
 25,0 cm, 9³/₄" **160-124-25**
 30,0 cm, 11³/₄" **160-124-30**

ALLIS-ATRAUMA



15,5 cm, 6" **160-020-15**
 20,0 cm, 8" **160-020-20**
 23,0 cm, 9" **160-020-23**

ALLEN

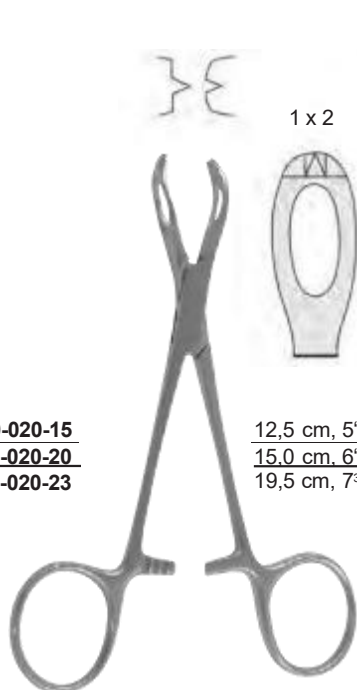

12,5 cm, 5" **160-030-12**
 15,0 cm, 6" **160-030-15**
 19,5 cm, 7³/₄" **160-030-19**

LANE



16,0 cm, 6¹/₄" **160-178-16**
 20,0 cm, 8" **160-178-20**

LOCKWOOD-ALLIS

Darm- und Gewebefazangen
 Intestinal and Tissue Grasping Forceps
 Pinzas intestinales y para tejidos
 Pinze da presa per intestino e tessuti



15,0 cm, 6"
 19,0 cm, 7½"

JUDD-ALLIS



2 x 3

LITTLEWOOD
 18,5 cm, 7¼"
 160-060-16



10 x 11

ALLIS-ADAIR
 15,5 cm, 6"
 160-010-15



BOYS-ALLIS
 15,5 cm, 6"
 160-012-15



6 x 7

THOMS-ALLIS
 20,0 cm, 8"
 160-050-20



ALLIS
 20,0 cm, 8"
 160-014-20

Darm- und Gewebefäßzangen
 Intestinal and Tissue Grasping Forceps
 Pinzas intestinales y para tejidos
 Pinze da presa per intestino e tessuti



LOCKWOOD
 20,0 cm, 8"
 160-169-20



WILLIAMS
 16,0 cm, 6 1/4"
 160-070-16



16,0 cm, 6 1/4" **160-006-16**
 18,0 cm, 7" **160-006-18**
 20,0 cm, 8" **160-006-20**
 24,0 cm, 9 1/2" **160-006-24**

BABCOCK



16,0 cm, 6 1/4" **164-006-16**
 20,0 cm, 8" **164-006-20**

BABCOCK-ATRAUMA



16,0 cm, 6 1/4" **161-006-16**
 20,0 cm, 8" **161-006-20**

BABCOCK-T C



DUVAL-TC
 20,0 cm, 8"
 161-170-20



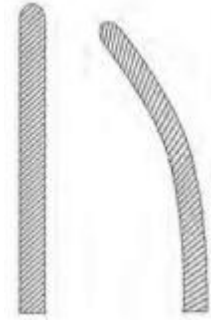

200-18

160-201-18



$8\frac{1}{4}$ " 160-210-21
9" 160-210-23



Darmklemmen



DUVAL

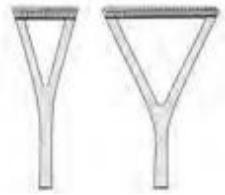

18,0 cm, 7"	160-170-18	
20,0 cm, 8"	160-170-20	160-172-20
23,0 cm, 9"		160-172-23

Darm- und Gewebefaßzangen
 Intestinal and Tissue Grasping Forceps
 Pinzas intestinales y para tejidos
 Pinze da presa per intestino e tessuti



BABY-DOYEN
 18,0 cm, 7"

160-



DOYEN

21,0 cm,
 23,0 cm,



21,0 cm, 8 1/4"	160-211-21
23,0 cm, 9"	160-211-23

Darmklemmen
 Intestinal Clamp Forceps
 Pinzas-clamps intestinales
 Pinze intestinal i



DOYEN



21,0 cm, 8 1/4" **164-210-21**
23,0 cm, 9" **164-210-23**



21,0 cm, 8 1/4" **164-211-21**
23,0 cm, 9" **164-211-23**

mittraumatischer Zahnung
 with atraumatic serration
 con bacosatraumáticas
 con morsiatraumatici



KOCHER



22,0 cm, 8 5/8" **160-234-22**
25,0 cm, 9 3/4" **160-234-25**
28,0 cm, 11" **160-234-28**



22,0 cm, 8 5/8" **160-235-22**
25,0 cm, 9 3/4" **160-235-25**
28,0 cm, 11" **160-235-28**

Darmklemmen
 Intestinal Clamp Forceps
 Pinzas-clamps intestinales
 Pinze intestinali



mittraumatischer Zahnung
 with atraumatic serration
 con bacosatraumáticas
 con morsiatraumatici

KOCHER

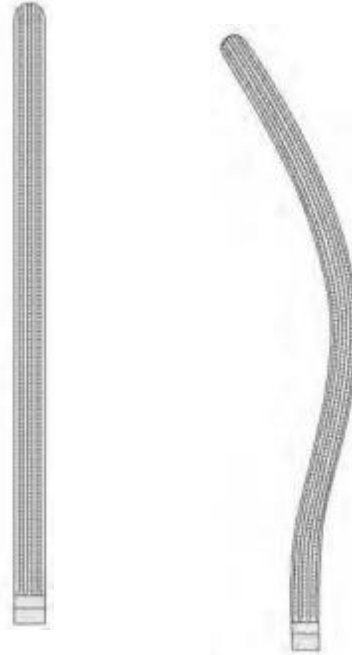

- | | | | |
|---|-------------------|---|-------------------|
| <u>22,0 cm, 8⁵/₈"</u> | 164-234-22 | <u>22,0 cm, 8⁵/₈"</u> | 164-235-22 |
| <u>25,0 cm, 9³/₄"</u> | 164-234-25 | <u>25,0 cm, 9³/₄"</u> | 164-235-25 |
| <u>28,0 cm, 11"</u> | 164-234-28 | <u>28,0 cm, 11"</u> | 164-235-28 |



MAYO-ROBSON

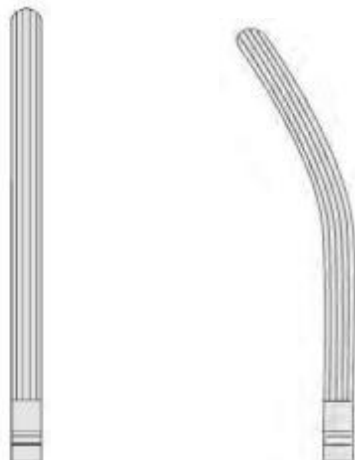

- | | | | |
|---|-------------------|---|-------------------|
| <u>21,0 cm, 8¹/₄"</u> | 160-230-21 | <u>21,0 cm, 8¹/₄"</u> | 160-231-21 |
| <u>23,0 cm, 9"</u> | 160-230-23 | <u>23,0 cm, 9"</u> | 160-231-23 |
| <u>25,0 cm, 9³/₄"</u> | 160-230-25 | <u>25,0 cm, 9³/₄"</u> | 160-231-25 |

Darmklemmen

Intestinal Clamp Forceps

Pinzas-clamps intestinales

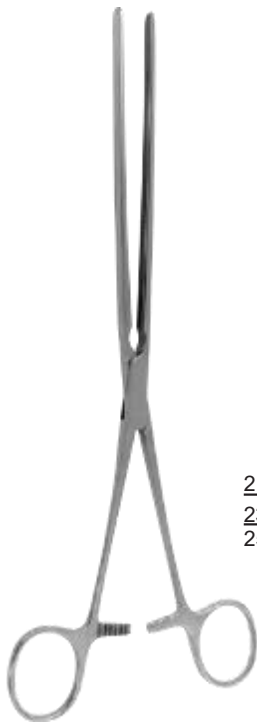

MAYO-ROBSON

21,0 cm, 8 1/4" **164-230-21**
 23,0 cm, 9" **164-230-23**
 25,0 cm, 9 3/4" **164-230-25**

mittraumatischer Zahnung
 with atraumatic serration
 con bacosatraumáticas
 con morsiatraumatici



21,0 cm, 8 1/4" **164-231-21**
 23,0 cm, 9" **164-231-23**
 25,0 cm, 9 3/4" **164-231-25**



BRUNNER
 24,0 cm, 9 1/2"
160-240-24

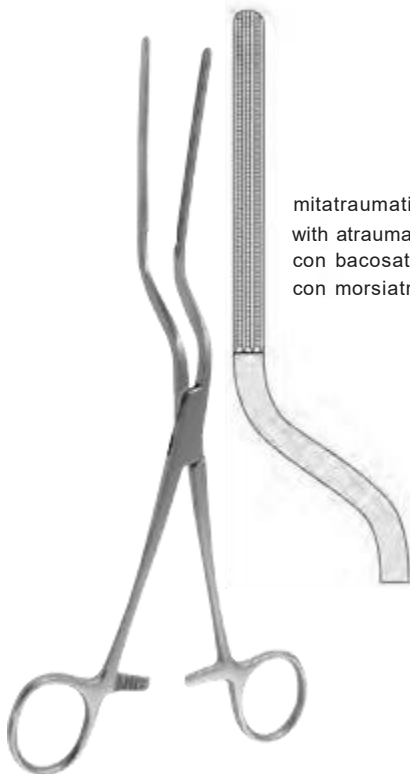

BRUNNER
 24,0 cm, 9 1/2"
164-240-24

mittraumatischer Zahnung
 with atraumatic serration
 con bacosatraumáticas
 con morsiatraumatici

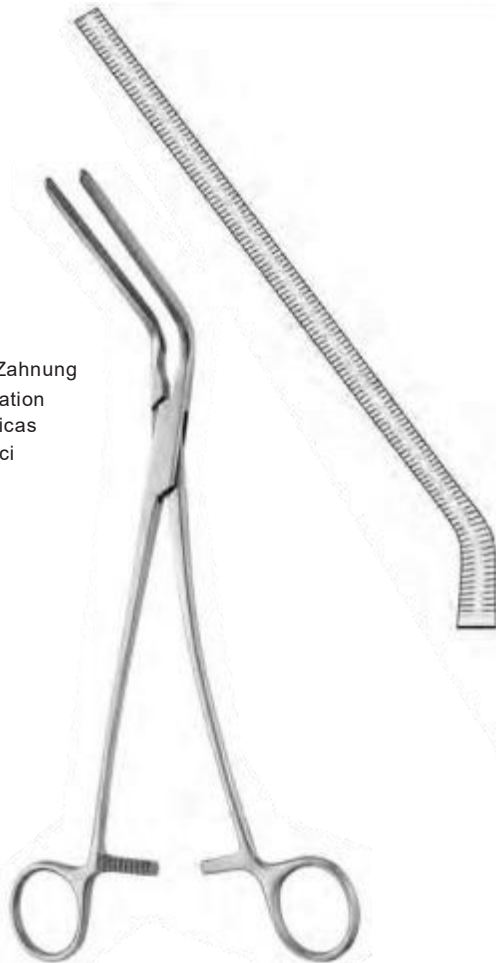

GLASSMAN
 23,0 cm, 9"
160-259-23

GLASSMAN
 23,5 cm, 9 1/4"
160-253-23

Darm- und Magenquetschklappen
 Intestinal and Stomach Clamps
 Pinzas-clamps intestinales y estomacales
 Pinze/Clamp per intestino e stomaco



Maullänge
 length of jaws
 longitud dela boca
 bocche lungh

5,0 cm, 2" **160-320-05**
7,0 cm, 2 1/2" **160-320-07**
10,0 cm, 4" **160-320-10**

DE MARTEL-WOLFSON



DE MARTEL-WOLFSON
 8,5 cm, 3 1/2"
160-340-08



DE MARTEL-WOLFSON
 26,0 cm, 10 1/4"
160-325-26



BABY-PAYR
 15,0 cm, 6"



160-310-15
 mit Stift
 with pin
 con espiga
 con perno



160-311-15
 ohne Stift
 without pin
 sinespiga
 senza perno



PAYR

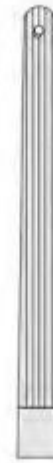

21,0 cm, 8 1/4" **160-310-21** **160-311-21**
29,0 cm, 11 1/2" **160-310-29** **160-311-29**

mit Stift ohne Stift
 with pin without pin
 con espiga sin espiga
 con perno senza perno

Darm- und Magenklappen
 Intestinal and Stomach Clamp Forceps
 Pinzas-clamps intestinales y estomacales
 Pinze per intestino e stomaco

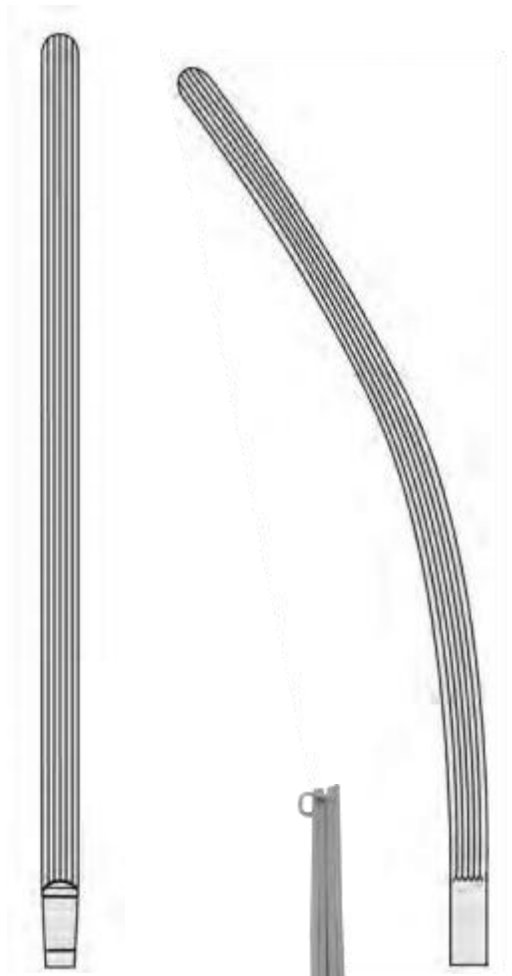

160-360-30

160-361-30

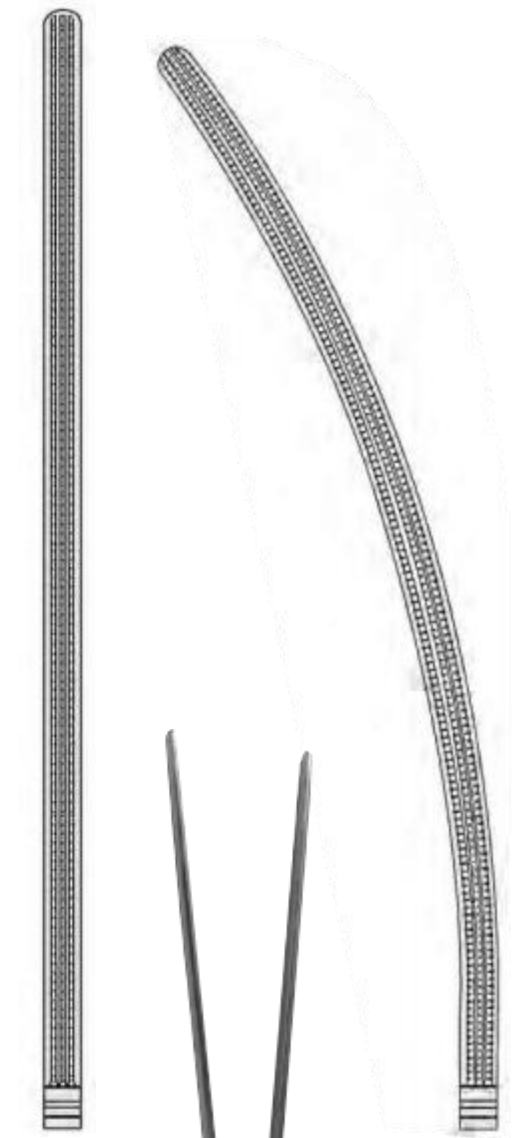

160-364-33

160-365-33

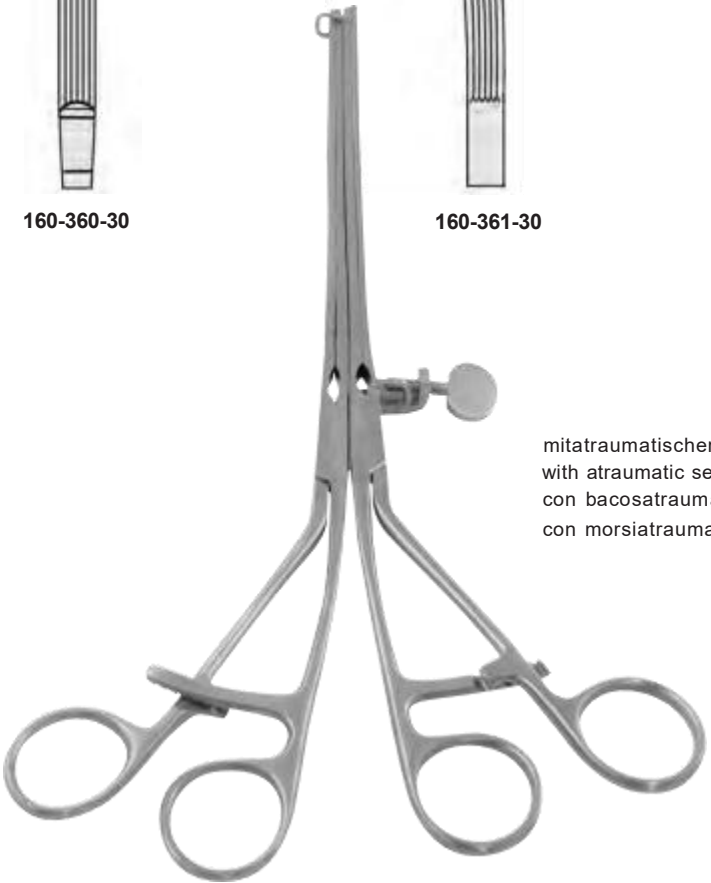

LANE
 30,0 cm, 11³/₄"

mittraumatischer Zahnung
 with atraumatic serration
 con bacosatraumáticas
 con morsiatraumatici



SCUDDER
 33,0 cm, 13"

Rektum-Anastomosenklemmen
SigmoidAnastomosis Forceps
Pinzas para anastomosis de recto
Pinze per anastomosi de retto



MIKULICZ
19,0 cm, 7 1/2"
168-010-19



HAYES

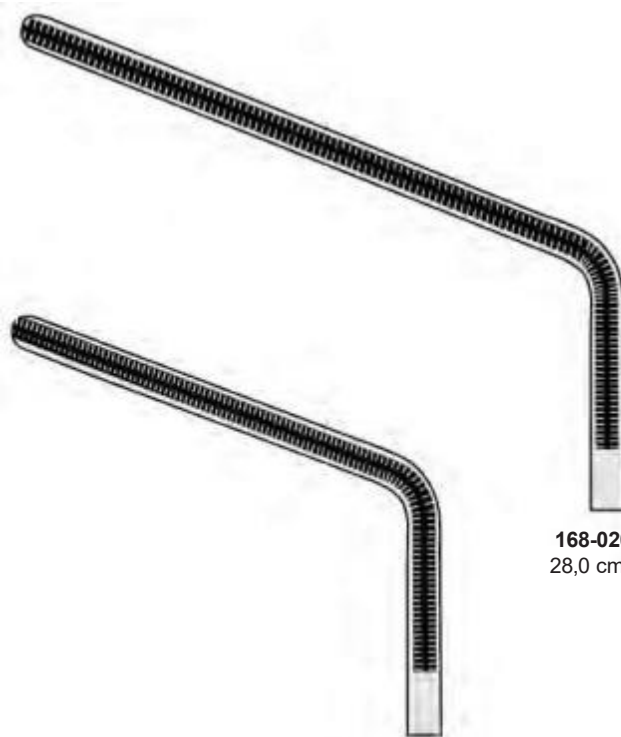

168-020-28
28,0 cm, 11"

168-020-26
26,0 cm, 10"

Mastdarm-Rektum-Spekula
Rectal Specula
Espéculos para el recto
Speculi rettali

17 x 89 mm



SIMS
15,0 cm, 6"
168-108-15

17 x 89 mm



SIMS
15,0 cm, 6"
168-110-15

25 x 89 mm



MATHIEU
21,0 cm, 8 1/4"
168-150-21

75 x 23 mm

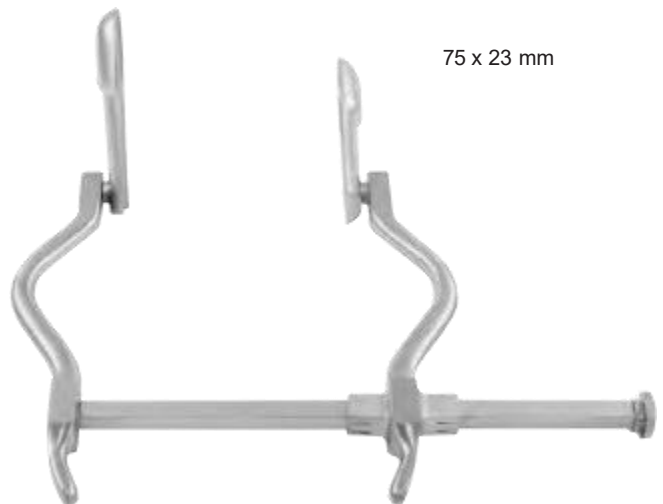

SMITH-BUIE
15,0 cm, 6"
168-160-15

**Anal spreizer, Sphinkteroskope, Anuskope
Rectal Retractor, Sphincteroscopes, Anoscope
Separadores para el recto, Esfinteroscopios, Anoscopios
Dilatatori per l'ano ed il retti, Sfinteroscopi, Anoscopi**

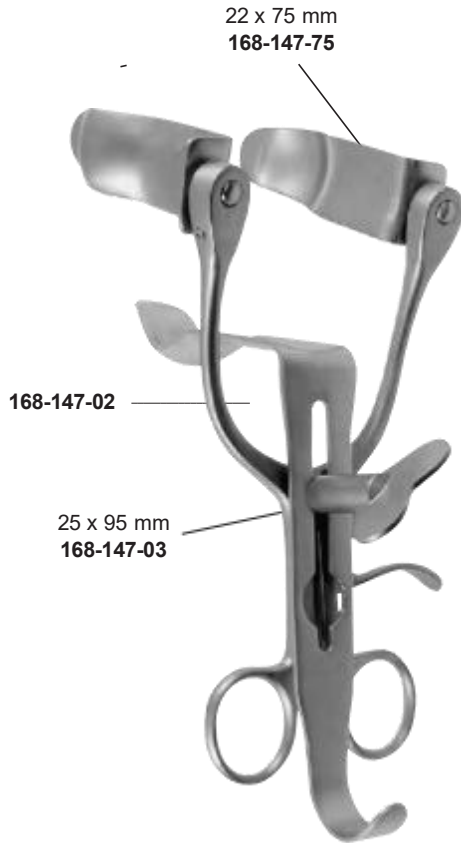

ALAN PARKS
13,5 cm, 5³/₈"
168-147-00

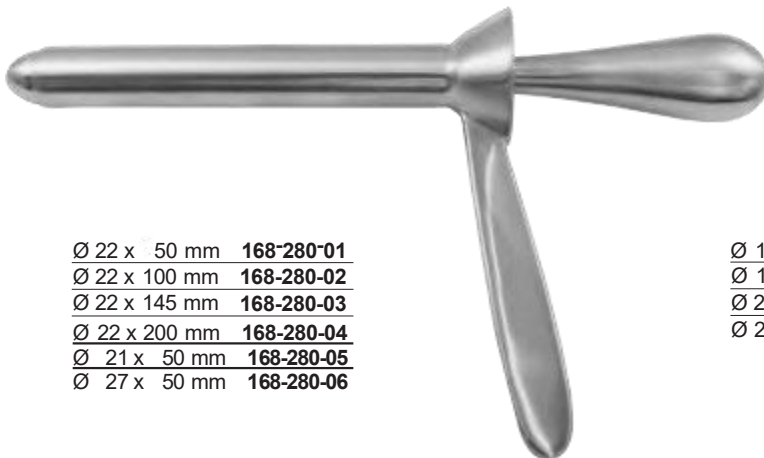

- Ø 22 x 50 mm **168-280-01**
- Ø 22 x 100 mm **168-280-02**
- Ø 22 x 145 mm **168-280-03**
- Ø 22 x 200 mm **168-280-04**
- Ø 21 x 50 mm **168-280-05**
- Ø 27 x 50 mm **168-280-06**

HAYES



- Ø 16 x 65 mm **168-212-01**
- Ø 19 x 65 mm **168-212-02**
- Ø 22 x 65 mm **168-212-03**
- Ø 22 x 130 mm **168-212-04**

HIRSCHMANN

Anuskope, Proktoskope
Anoscope, Proctoscopes
Anoscopios, Proctoscopios
Anoscopi, Protoscopi



Ø 22 x 65 mm **168-250-22**
Ø 30 x 65 mm **168-250-30**

CHELSEA EATON



ohne Kaltlichtträger
without cold light carrier
sin portador para luz fría
senza luce fredda

IVES FANSLER
Ø 22 mm
168-268-01

mit Kaltlichtträger
with cold light carrier
con portador para luz fría
con luce fredda

IVES FANSLER
Ø 22 mm
168-268-02

Mastdarm-Biopsiezangen
Rectal Biopsy Forceps
Pinzas sacabocado para biopsia rectal
Pinze taglienti per biopsia rettale

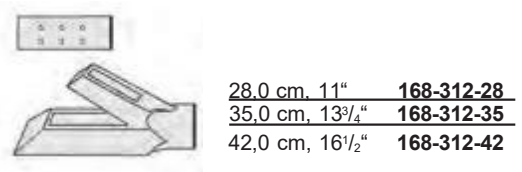
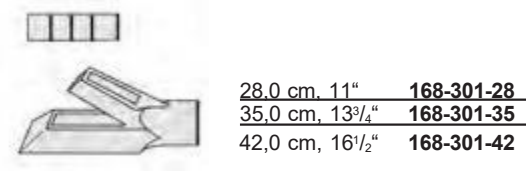
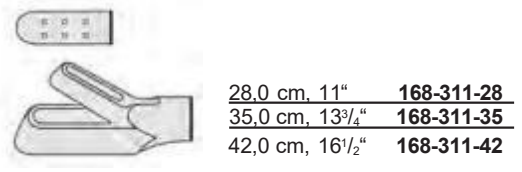
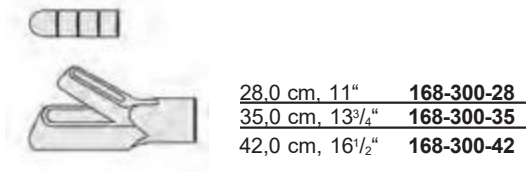

Hämorrhoiden-Faßzangen, Fistelsonden
Haemorrhoidal Forceps, Fistula probes
Pinza-clamps para hemorroides, Sondas para fistula
Pinze per emorroidi, Sonde per fistola



MC GIVNEY
19,0 cm, 7 1/2"
168-471-19



MC GIVNEY
19,0 cm, 7 1/2"
168-473-19



PRATT
21,0 cm, 8 1/4"



080-135-01



080-135-02



080-135-03

Gynäkologie, Geburtshilfe
Gynecology, Obstetrics
Ginecología, Obstetricia
Ginecologia, Ostetricia



Scheidenspekula
 Vaginal Specula
 Espéculos vaginales
 Speculi vaginali

für Jungfrauen
 for virgins
 para vírgenes
 per vergini



COLLIN
 65 x 10 mm
 180-132-00

für Kinder
 for children
 para niños
 per bambini



COLLIN
 65 x 10 mm
 180-134-00

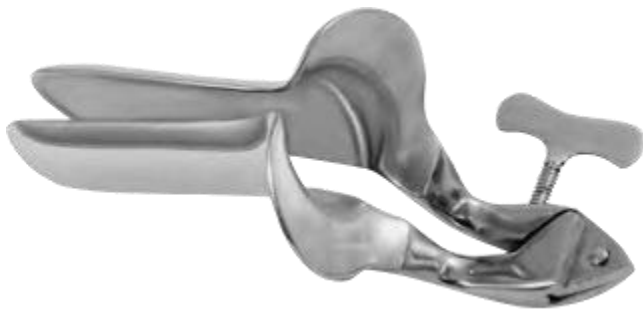

COLLIN

85 x 30 mm	180-130-01
100 x 35 mm	180-130-02
110 x 40 mm	180-130-03



80 x 24 mm	180-142-01
80 x 32 mm	180-142-02
98 x 16 mm	180-142-03
105 x 25 mm	180-142-04
107 x 29 mm	180-142-05
115 x 35 mm	180-142-06

**Scheidenspekula
Vaginal Specula
Espéculos vaginales
Spec uli vaginali**

zentrale Stellschraube
central fixation screw
tornillodesujeto central
vite diregolazione centrale



CUSCO

75 x 32 mm	180-144-01
85 x 36 mm	180-144-02
95 x 37 mm	180-144-03

seitliche Stellschraube
lateral fixation screw
tornillodesujeto lateral
vite diregolazione laterale



für Jungfrauen
for virgins
para vírgenes
per vergini

CUSCO
75 x 17 mm
180-140-00

seitliche Stellschraube
lateral fixation screw
tornillodesujeto lateral
vite diregolazione laterale



CUSCO

75 x 32 mm	180-140-01
85 x 35 mm	180-140-02
100 x 35 mm	180-140-03

Schweizer Modell
Swiss pattern
Modelo suizo
Modello svizzero



CUSCO

90 x 23-25 mm	180-146-01
100 x 25-27 mm	180-146-02
110 x 27-30 mm	180-146-03

Scheidenspekula
 Vaginal Specula
 Espéculos vaginales
 Speculi vaginali



GRAVE

75 x 20 mm	180-100-01
95 x 35 mm	180-100-02
115 x 35 mm	180-100-03



PEDERSON

75 x 13 mm	180-120-01
100 x 22 mm	180-120-02
120 x 25 mm	180-120-03



SEMM

90 x 14-18 mm	180-150-01
100 x 17-20 mm	180-150-02
100 x 25-30 mm	180-150-03



WEISSBARTH
 21,0 cm, 8 1/4"
180-160-00

Scheidenspekula
 Vaginal Specula
 Espéculos vaginales
 Speculi vaginali



mit abnehmbarem Gewicht
 with detachable weight
 con peso desmontable
 con peso smontabile

1,14 kg

AUVARD
 75 x 38 mm
 180-170-00



mit festem Gewicht
 with fixed weight
 con peso fijo
 con peso fisso

1,14 kg

AUVARD
 75 x 38 mm
 180-172-00



180-180-03

400 g
 180-180-40

800 g
 180-180-80

SCHERBACK
 180-180-00

koplett, complete, completo, completo

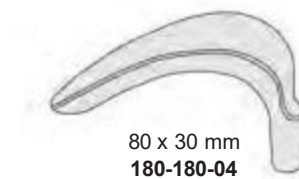

80 x 30 mm
 180-180-04

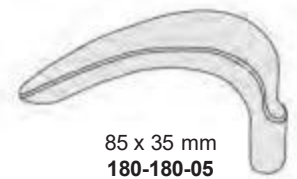

85 x 35 mm
 180-180-05

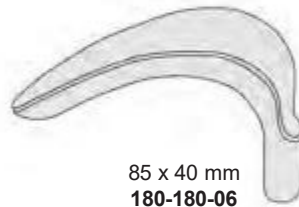

85 x 40 mm
 180-180-06



55 x 40-60 mm
 180-180-07

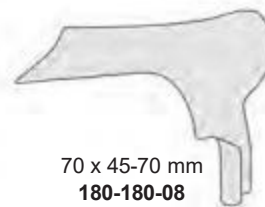

70 x 45-70 mm
 180-180-08

Scheidenspekula
 Vaginal Specula
 Espéculos vaginales
 Speculi vaginali



Satz
 Set
 Juego
 Set

KRISTELLER

Fig. 1 **180-220-01**



Spekula allein, flach
 Specula only, flat hollow
 Espéculossuelto, con huecos planos
 Solo speculi, piatta

KRISTELLER

105 x 26 mm	180-221-01
105 x 28 mm	180-221-02
105 x 33 mm	180-221-03

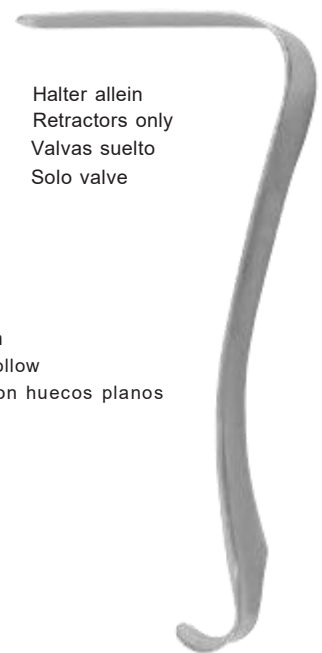

Halter allein
 Retractors only
 Valvas suelto
 Solo valve

KRISTELLER

115 x 22 mm	180-222-01
115 x 24 mm	180-222-02
115 x 29 mm	180-222-03



Satz
 Set
 Juego
 Set

KRISTELLER

Fig. 1 **180-230-01**



Spekula allein, flach
 Specula only, flat hollow
 Espéculossuelto, con huecos planos
 Solo speculi, piatta

KRISTELLER

110 x 27 mm	180-231-01
110 x 30 mm	180-231-02
110 x 36 mm	180-231-03



Halter allein
 Retractors only
 Valvas suelto
 Solo valve

KRISTELLER

115 x 23 mm	180-232-01
115 x 26 mm	180-232-02
115 x 32 mm	180-232-03

Scheidenspekula
Vaginal Specula
Espéculos vaginales
Speculi vaginali



Satz
Set
Juego
Set

KRISTELLER

Fig. 0 **180-234-00**
Fig. 1 **180-234-01**
Fig. 2 **180-234-02**
Fig. 3 **180-234-03**

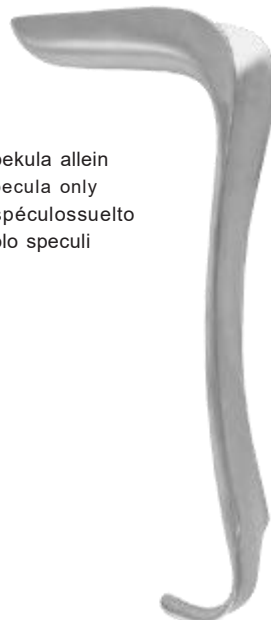

Spekula allein
Specula only
Espéculossuelto
Solo speculi

KRISTELLER

70 x 15 mm **180-235-00**
70 x 27 mm **180-235-01**
80 x 30 mm **180-235-02**
90 x 36 mm **180-235-03**



Halter allein
Retractors only
Valvas suelto
Solo valve

KRISTELLER

75 x 10 mm **180-236-00**
75 x 23 mm **180-236-01**
85 x 26 mm **180-236-02**
100 x 32 mm **180-236-03**



konisch, für Jungfrauen
conical blades, for virgins
valvos cónicos, para vírgenes
valve coniche, per vergini

Satz
Set
Juego
Set

KRISTELLER

Fig. 00 **180-237-01**
Fig. 0 **180-237-02**

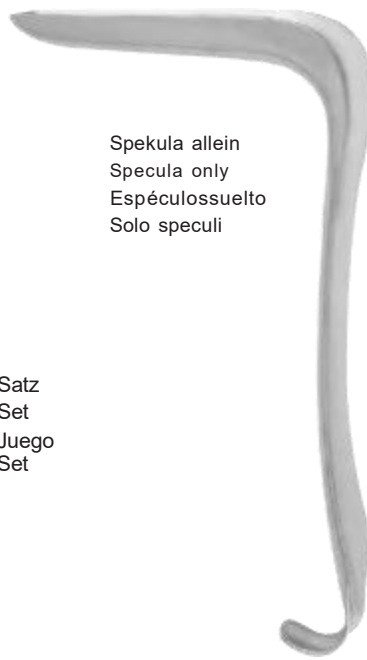

Spekula allein
Specula only
Espéculossuelto
Solo speculi

KRISTELLER

105 x 18 mm **180-238-01**
105 x 21 mm **180-238-02**



Halter allein
Retractors only
Valvas suelto
Solo valve

KRISTELLER

110 x 14 mm **180-239-01**
110 x 17 mm **180-239-02**

Scheidenspekula
Vaginal Specula
Espéculos vaginales
Speculi vaginali



leicht-hohl
slightly-concave
ligeremente concavos
leggeremente concavi

Fig	a x b	
1	55 x 35 mm	180-260-01
2	85 x 35 mm	180-260-02
3	115 x 35 mm	180-260-03
1	55 x 45 mm	180-261-01
2	85 x 45 mm	180-261-02
3	115 x 45 mm	180-261-03
4	160 x 45 mm	180-261-04
1	55 x 60 mm	180-262-01
2	85 x 60 mm	180-262-02
3	115 x 60 mm	180-262-03
4	160 x 60 mm	180-262-04

DOYEN
23,0 cm, 9"



halb-hohl
medium-concave
semi-concavos
semi-concavi

Fig	a x b	
1	55 x 35 mm	180-264-01
2	85 x 35 mm	180-264-02
3	115 x 35 mm	180-264-03
1	55 x 45 mm	180-265-01
2	85 x 45 mm	180-265-02
3	115 x 45 mm	180-265-03
1	55 x 60 mm	180-266-01
2	85 x 60 mm	180-266-02
3	115 x 60 mm	180-266-03

DOYEN
23,0 cm, 9"

Scheidenspekula
Vaginal Specula
Espéculos vaginales
Speculi vaginali



Satz
Set
Juego
Set

KALLMORGEN

70 x 40 mm	180-270-01
90 x 40 mm	180-270-02



Spekula allein
Specula only
Espéculos sueltos
Solo speculi

KALLMORGEN

70 x 40 mm	180-271-01
90 x 40 mm	180-271-02

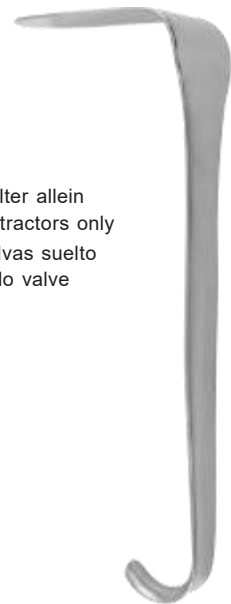

Halter allein
Retractors only
Valvas sueltas
Solo valvas

KALLMORGEN

70 x 40 mm	180-272-01
90 x 40 mm	180-272-02



70 x 15 mm

KRISTELLER
17,0 cm, 6³/₄"
180-275-17



75 x 39 mm

KALLMORGEN
17,0 cm, 6³/₄"
180-290-17



JACKSON

75 x 38 mm	180-290-01
90 x 38 mm	180-290-02
100 x 38 mm	180-290-03

Scheidenspekula
Vaginal Specula
Espéculos vaginales
Speculi vaginali

76 x 25 mm



70 x 22 mm

BREISKY
14,0 cm, 5½"
180-292-01

82 x 30 mm



76 x 25 mm

BREISKY
14,0 cm, 5½"
180-292-02

95 x 38 mm

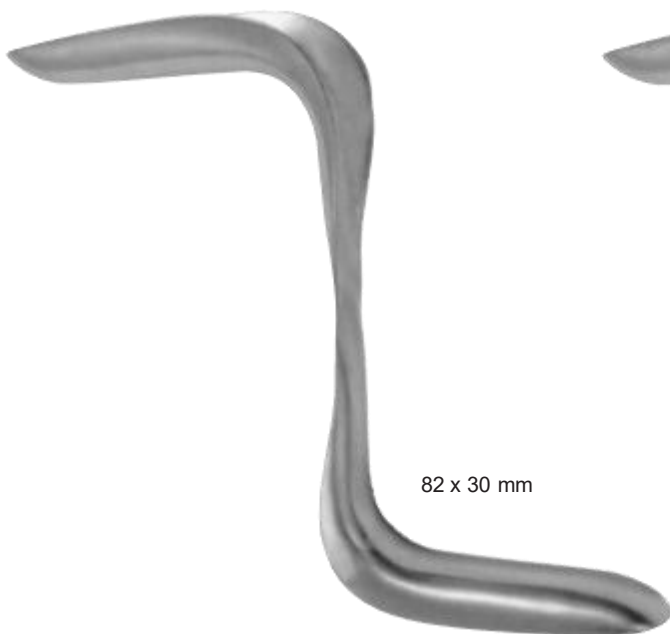

82 x 30 mm

BREISKY
17,0 cm, 6¾"
180-292-03

102 x 44 mm

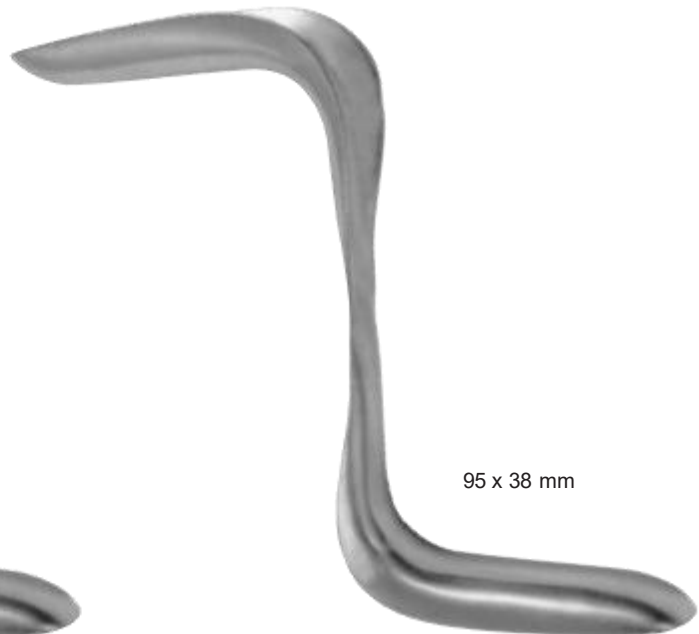

95 x 38 mm

BREISKY
17,0 cm, 6¾"
180-292-04

**Scheidenspekula und -halter
Vaginal Specula and Retractors
Espéculos y valvas vaginales
Speculi e valve vaginali**

SIMS
57-8294-00
Satz, Set, Juego, Set, набор

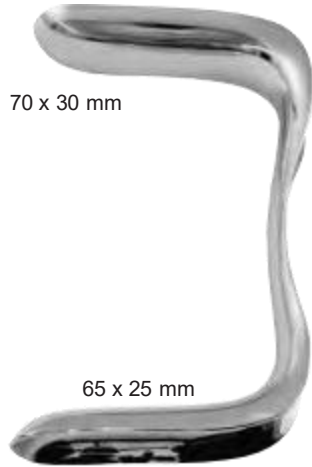

SIMS
12,5 cm, 5"
180-294-01



SIMS
15,0 cm, 6"
180-294-02

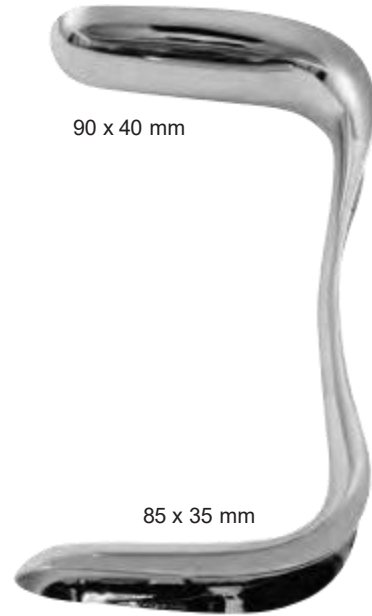

SIMS
17,5 cm, 7"
180-294-03



MATHIEU

100 x 13-23 mm **180-300-01**
100 x 16-30 mm **180-300-02**



MATHIEU

100 x 11-21 mm **180-301-01**
100 x 14-27 mm **180-301-02**



LANDAU

100 x 28 mm **180-305-01**
100 x 38 mm **180-305-02**

Scheidenspekula
 Vaginal Specula
 Espéculos vaginales
 Speculi vaginali



- | | |
|-------------|-------------------|
| 100 x 20 mm | 180-307-20 |
| 100 x 25 mm | 180-307-25 |
| 100 x 30 mm | 180-307-30 |
| 100 x 35 mm | 180-307-35 |
| 100 x 40 mm | 180-307-40 |
| <hr/> | |
| 130 x 20 mm | 180-308-20 |
| 130 x 25 mm | 180-308-25 |
| 130 x 30 mm | 180-308-30 |
| 130 x 35 mm | 180-308-35 |
| 130 x 40 mm | 180-308-40 |
| <hr/> | |
| 155 x 40 mm | 180-309-40 |

BREISKY



85 x 17 mm

BRAUN, MODIF.
 19,0 cm, 7 1/2"
180-313-19



60 x 30 mm

DOYEN
 23,0 cm, 9"
180-315-23



80 x 30 mm

DOYEN
 25,0 cm, 9"
180-315-25



95 x 38 mm

WERTHEIM
 30,0 cm, 12"
180-317-30

Endospekula, Lateral-Spekulum, Intrauterinsonde
Endospecula, Lateral Speculum, Intrauterine Probe
Endoespécucos, Espéculo lateral, Sonda intra-uterina
Endospeculi, Speculo lateral, Sonde intrauterine

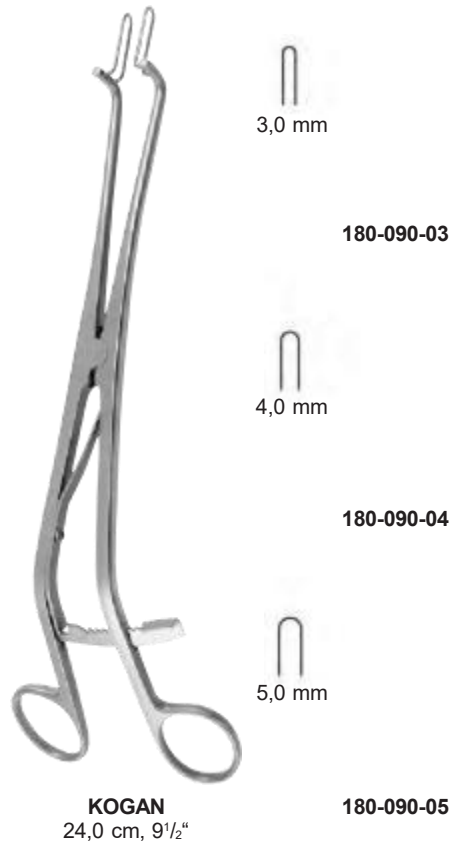
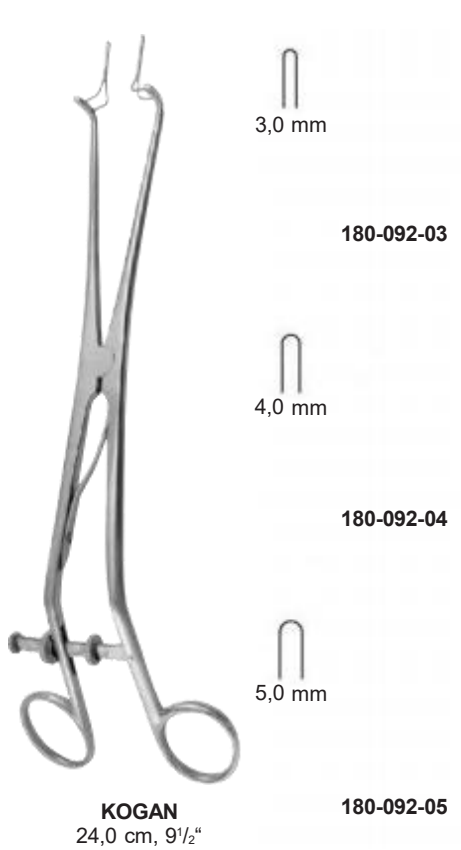

**Uterus-Dilatatoren
Uterine Dilators
Dilatadores uterinos
Dilatatori uterini**



HEGAR
18,5 cm, 7 1/4"

Ø 1.0 mm	180-350-01
Ø 2.0 mm	180-350-02
Ø 3.0 mm	180-350-03
Ø 4.0 mm	180-350-04
Ø 5.0 mm	180-350-05
Ø 6.0 mm	180-350-06
Ø 7.0 mm	180-350-07
Ø 8.0 mm	180-350-08
Ø 9.0 mm	180-350-09
Ø 10.0 mm	180-350-10
Ø 11.0 mm	180-350-11
Ø 12.0 mm	180-350-12
Ø 13.0 mm	180-350-13
Ø 14.0 mm	180-350-14
Ø 15.0 mm	180-350-15
Ø 16.0 mm	180-350-16
Ø 17.0 mm	180-350-17
Ø 18.0 mm	180-350-18
Ø 19.0 mm	180-350-19
Ø 20.0 mm	180-350-20
Ø 21.0 mm	180-350-21
Ø 22.0 mm	180-350-22
Ø 23.0 mm	180-350-23
Ø 24.0 mm	180-350-24
Ø 25.0 mm	180-350-25
Ø 26.0 mm	180-350-26



HEGAR
18,5 cm, 7 1/4"

Ø 1,5 mm	180-351-01
Ø 2,5 mm	180-351-02
Ø 3,5 mm	180-351-03
Ø 4,5 mm	180-351-04
Ø 5,5 mm	180-351-05
Ø 6,5 mm	180-351-06
Ø 7,5 mm	180-351-07
Ø 8,5 mm	180-351-08
Ø 9,5 mm	180-351-09
Ø 10,5 mm	180-351-10
Ø 11,5 mm	180-351-11
Ø 12,5 mm	180-351-12
Ø 13,5 mm	180-351-13
Ø 14,5 mm	180-351-14
Ø 15,5 mm	180-351-15
Ø 16,5 mm	180-351-16
Ø 17,5 mm	180-351-17



205 x 105 x 45 mm

HEGAR
180-350-99
Satz, Set, Juego, Set
Ø 1,0 - Ø 26,0
(26 dilators)

HEGAR
180-350-98
Satz, Set, Juego, Set
Ø 4,0 - Ø 17,0
(14 dilators)

Uterus-Dilatatoren
 Uterine Dilators
 Diladores uterinos
 Dilatori uterini



HEGAR
 20,0 cm, 8"

Ø 2,0 / 2,0 mm	180-354-01
Ø 4,0 / 4,0 mm	180-354-03
Ø 6,0 / 6,0 mm	180-354-05
Ø 8,0 / 8,0 mm	180-354-07
Ø 9,0 / 10,0 mm	180-354-09
Ø 11,0 / 12,0 mm	180-354-11
Ø 13,0 / 14,0 mm	180-354-13
Ø 15,0 / 16,0 mm	180-354-15
Ø 17,0 / 18,0 mm	180-354-17
Ø 19,0 / 20,0 mm	180-354-19
Ø 21,0 / 22,0 mm	180-354-21
Ø 23,0 / 24,0 mm	180-354-23
Ø 25,0 / 26,0 mm	180-354-25



HEGAR
180-354-98
 Satz, Set, Juego, Set
 Ø 3,0 / 4,0 - Ø 17,0 / 18,0 mm
 (8 dilators)

HEGAR
180-354-99
 Satz, Set, Juego, Set
 Ø 1,0 / 2,0 - Ø 25,0 / 26,0 mm
 (13 dilators)



HANK

Ø 4,5 / 5,0 mm	180-360-05
Ø 5,5 / 6,0 mm	180-360-06
Ø 6,5 / 7,0 mm	180-360-07
Ø 7,5 / 8,0 mm	180-360-08
Ø 8,5 / 9,0 mm	180-360-09
Ø 9,5 / 10,0 mm	180-360-10



HANK
180-360-98
 Satz, Set, Juego, Set
 Ø 4,5 / 5,0 - Ø 9,5 / 10,0 mm
 (6 dilators)

Uterus-Dilatatoren, Hakenzangen
 Uterine Dilators, Uterine Tenaculum Forceps
 Diladores uterinos, Pinzas para coger el cuello del útero
 Dilatori uterini, Pinze per abbassare il collo dell'utero



PRATT

Ø 5 /	5,0 mm	180-370-05
Ø 5 /	6,0 mm	180-370-06
Ø 5 /	8,0 mm	180-370-08
Ø 5 /	9,0 mm	180-370-09
Ø	9,5 / 10,0 mm	180-370-10
Ø	11,5 / 12,0 mm	180-370-12
Ø	12,5 / 13,0 mm	180-370-13
Ø	13,5 / 14,0 mm	180-370-14



PRATT
180-370-98
 Satz, Set, Juego, Set
 Ø 4,5 / 5,0 - Ø 13,5 / 14,0 mm
 (8 dilators)



BARRETT
 18,0 cm, 7"
 180-410-18



ADAIR
 19,0 cm, 7½"
 180-412-19



STAUDE-MOORE
 17,0 cm, 6¾"
 180-414-17

Hakenzangen
Uterine Tenaculum Forceps
Pinzas para coger el cuello del útero
Pinze per abbassare il collo dell'utero



JARCHO
20,0 cm, 8"
180-417-20



SCHROEDER
25,0 cm, 9³/₄"
180-400-25



BRAUN
25,0 cm, 9³/₄"
180-404-25



DUPLAY
28,0 cm, 11"
180-419-28



POZZI
26,0 cm, 10¹/₄"
180-402-26



KAHN
24,0 cm, 9¹/₂"
180-421-24

Hakenzangen
Uterine Tenaculum Forceps
Pinzas para coger el cuello del útero
Pinze per abbassare il collo dell'utero



SKENE
24,0 cm, 9½"
180-423-24



SCHROEDER
24,0 cm, 9½"
180-426-24



SCHROEDER
24,0 cm, 9½"
180-429-24



TEALE
23,0 cm, 9"
180-431-23



JACOBS
21,0 cm, 8½"
180-434-21



JACOBS
21,0 cm, 8½"
180-435-21

Hakenzangen
 Uterine Tenaculum Forceps
 Pinzas para coger el cuello del útero
 Pinze per abbassare il collo dell'utero



MUSEUX
24,0 cm, 9½"



MUSEUX
24,0 cm, 9½"



BRAUN
15,5 cm, 6"
180-442-15



CZERNY
20,5 cm, 8"
180-444-20



PRATT
28,0 cm, 11"
180-446-28



IOWA
26,0 cm, 10¼"
180-449-26

Polypen- und Ovarienzangen, Uterusfaßzangen
Polypus and Ovum Forceps, Uterine Elevating Forceps
Pinzas para pólipos uterinos y ovarios, Pinzas para la útero
Pinze per polipi e ovaie, Pinze per affarrare l'utero



DOYEN
 20,5 cm, 8"
 180-470-20



NOTO
 27,0 cm, 10⁵/₈"
 180-472-27



KELLY
 32,0 cm, 12¹/₂"
 180-475-32



HEYWOOD-SMITH
 25,0 cm, 9³/₄"
 180-480-25



DARTIGUES
 27,0 cm, 10³/₄"
 180-482-27



SOMER
 23,0 cm, 9"
 180-485-23

Uterusfaßzangen, Uterussonden, Zentimereinteilung
Uterine Elevating Forceps, Uterine Probes, graduated in centimeters
Pinzas para la útero, Histerómetros, graduado en centrimetros
Pinze per affarrare l'utero, Isterometri, graduato in cm



COLLIN
 25,0 cm, 9³/₄"
 180-488-25



Amniotom
 Amniotome
 Amniótomo
 Amniotomo

BEACHAM
 26,0 cm, 10¹/₄"
 180-500-26



Uterus-Depressor
 Uterine depressor
 Depresor uterino
 Depressori uterini

BRAUN
 28,0 cm, 11"
 180-502-28



SIMS
 32,0 cm, 12¹/₂"
 180-510-32



biegsam
 malleable
 maleable
 malleabile

SIMS
 32,0 cm, 12¹/₂"
 180-511-32



MARTIN
 32,0 cm, 12¹/₂"
 180-516-32



biegsam
 malleable
 maleable
 malleabile

MARTIN
 32,0 cm, 12¹/₂"
 180-518-32



VALLEIX
 25,0 cm, 10"
 180-521-25



SIMPSON
 29,0 cm, 11¹/₂"
 180-527-29

Ø 4 mm

biegsam
 malleable
 maleable
 malleabile

Ø 4 mm



COLLIN
 28,0 cm, 11"
 180-529-28

Biopsieküretten
Biopsy Curettes
Curetas para biopsía
Curette per biopsia



KEVORKIAN
 30,0 cm, 12"
 180-540-30

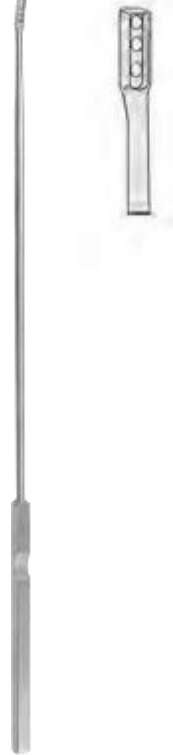

KEVORKIAN
 30,0 cm, 12"
 180-542-30



KEVORKIAN
 30,0 cm, 12"
 180-543-30



NOVAK
 23,0 cm, 9"
 180-550-04

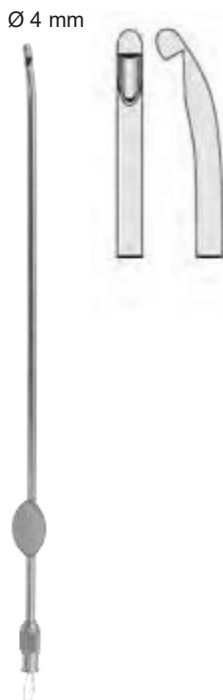

RANDALL
 23,0 cm, 9"
 180-552-04



MILAN
 29,0 cm, 11 1/2"

Ø 4 mm
 180-560-04

Ø 6 mm
 180-560-06

Ø 9 mm
 180-560-09

Myominstrumente
Myoma Instruments
Instrumentos para mioma
Strumenti per fibroma



25,0 cm, 9³/₄"
180-570-25



25,0 cm, 9³/₄"
180-572-25



SIMON
22,0 cm, 8⁵/₈"
180-574-22



EMMETT
22,0 cm, 8⁵/₈"



180-576-01



180-576-02



180-576-03



180-576-04



180-576-05



SEGOND
27,0 cm, 10⁵/₈"
180-580-27

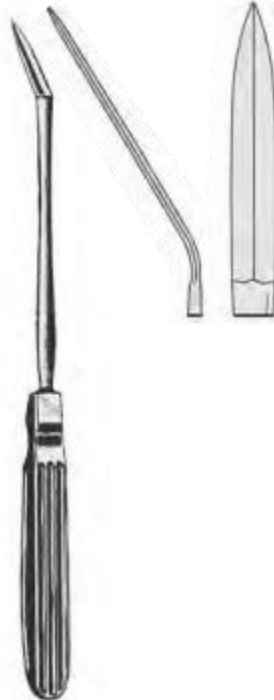

AYRE
23,0 cm, 9"
180-583-23



DOYEN
19,0 cm, 7¹/₂"
180-588-01



DOYEN
17,0 cm, 6³/₄"
180-588-02

**Uterusküretten
Uterine Curettes
Curetas uterinas
Curette uterine**

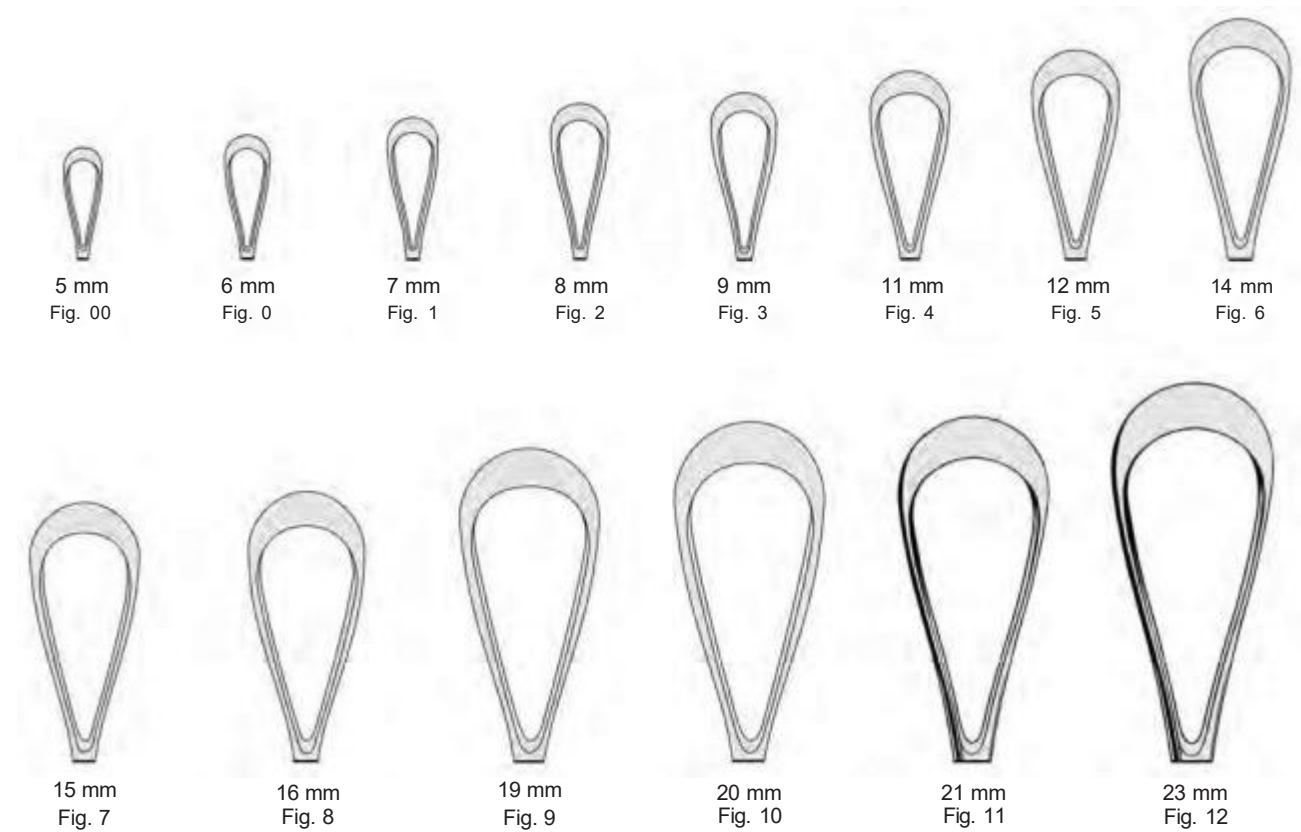

RECAMIER
26,0 cm, 10¹/₄"

scharf, fest
sharp, rigid
cortantes, rígidas
acute, rigide

Fig. 00	180-700-05
Fig. 01	180-700-06
Fig. 02	180-700-07
Fig. 03	180-700-08
Fig. 04	180-700-09
Fig. 05	180-700-11
Fig. 06	180-700-12
Fig. 07	180-700-14
Fig. 08	180-700-15
Fig. 09	180-700-16
Fig. 10	180-700-19
Fig. 11	180-700-20
Fig. 12	180-700-21
Fig. 13	180-700-23



scharf, biegsam
sharp, malleable
cortantes, maleable
acute, malleabile

Fig. 00	180-701-05
Fig. 01	180-701-06
Fig. 02	180-701-07
Fig. 03	180-701-08
Fig. 04	180-701-09
Fig. 05	180-701-11
Fig. 06	180-701-12
Fig. 07	180-701-14
Fig. 08	180-701-15
Fig. 09	180-701-16
Fig. 10	180-701-19
Fig. 11	180-701-20
Fig. 12	180-701-21
Fig. 13	180-701-23

RECAMIER
26,0 cm, 10¹/₄"

**Uterusküretten
Uterine Curettes
Curetas uterinas
Curette uterine**



5 mm
Fig. 00



6 mm
Fig. 0



7 mm
Fig. 1



8 mm
Fig. 2



9 mm
Fig. 3



11 mm
Fig. 4



12 mm
Fig. 5



14 mm
Fig. 6



15 mm
Fig. 7



16 mm
Fig. 8



19 mm
Fig. 9



20 mm
Fig. 10



21 mm
Fig. 11



23 mm
Fig. 12



SIMS
26,0 cm, 10¹/₄"

scharf, fest
sharp, rigid
cortantes, rígidas
acute, rigide

Fig. 00	180-702-05
Fig. 0	180-702-06
Fig. 01	180-702-07
Fig. 02	180-702-08
Fig. 03	180-702-09
Fig. 04	180-702-11
Fig. 05	180-702-12
Fig. 06	180-702-14
Fig. 07	180-702-15
Fig. 08	180-702-16
Fig. 09	180-702-19
Fig. 10	180-702-20
Fig. 11	180-702-21
Fig. 12	180-702-23



SIMS
26,0 cm, 10¹/₄"

scharf, biegsam
sharp, malleable
cortantes, maleable
acute, malleabile

Fig. 00	180-703-05
Fig. 0	180-703-06
Fig. 01	180-703-07
Fig. 02	180-703-08
Fig. 03	180-703-09
Fig. 04	180-703-11
Fig. 05	180-703-12
Fig. 06	180-703-14
Fig. 07	180-703-15
Fig. 08	180-703-16
Fig. 09	180-703-19
Fig. 10	180-703-20
Fig. 11	180-703-21
Fig. 12	180-703-23

Uterusküretten
 Uterine Curettes
 Curetas uterinas
 Curette uterine

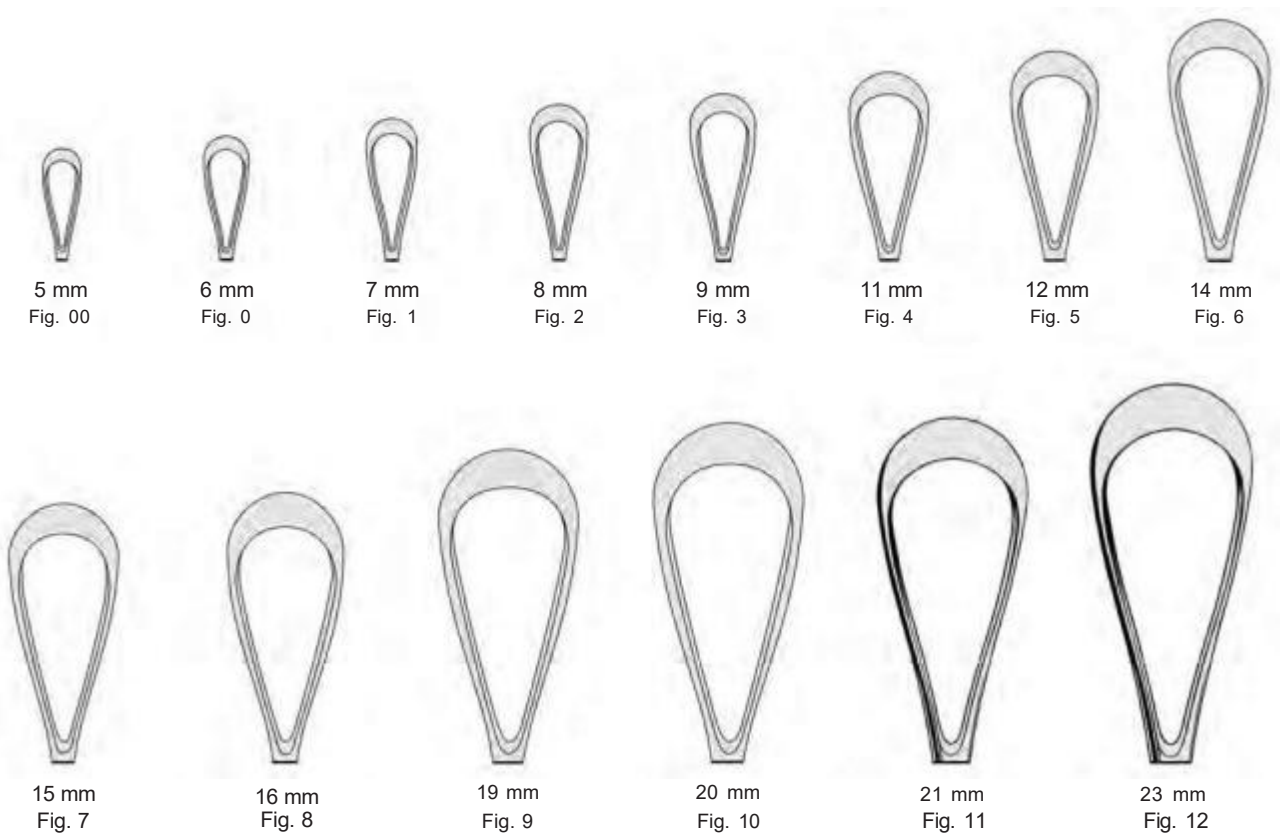

scharf, fest
 sharp, rigid
 cortantes, rígidas
 acute, rigide

scharf, biegsam
 sharp, malleable
 cortantes, maleable
 acute, malleabile

Fig. 00	180-710-05
Fig. 0	180-710-06
Fig. 1	180-710-07
Fig. 2	180-710-08
Fig. 3	180-710-09
Fig. 4	180-710-11
Fig. 5	180-710-12
Fig. 6	180-710-14
Fig. 7	180-710-15
Fig. 8	180-710-16
Fig. 9	180-710-19
Fig. 10	180-710-20
Fig. 11	180-710-21
Fig. 12	180-710-23

Fig. 00	180-711-05
Fig. 0	180-711-06
Fig. 1	180-711-07
Fig. 2	180-711-08
Fig. 3	180-711-09
Fig. 4	180-711-11
Fig. 5	180-711-12
Fig. 6	180-711-14
Fig. 7	180-711-15
Fig. 8	180-711-16
Fig. 9	180-711-19
Fig. 10	180-711-20
Fig. 11	180-711-21
Fig. 12	180-711-23

RECAMIER
 31,0 cm, 12¹/₄"

RECAMIER
 31,0 cm, 12¹/₄"

Uterusküretten
 Uterine Curettes
 Curetas uterinas
 Curette uterine



5 mm
 Fig. 00



6 mm
 Fig. 01



7 mm
 Fig. 1



8 mm
 Fig. 2



9 mm
 Fig. 3



11 mm
 Fig. 4



12 mm
 Fig. 5



14 mm
 Fig. 6



15 mm
 Fig. 7



16 mm
 Fig. 8



19 mm
 Fig. 9



20 mm
 Fig. 10



21 mm
 Fig. 11



23 mm
 Fig. 12



scharf, fest
 sharp, rigid
 cortantes, rígidas
 acute, rigide

Fig. 00	180-712-05
Fig. 01	180-712-06
Fig. 02	180-712-07
Fig. 03	180-712-08
Fig. 04	180-712-09
Fig. 05	180-712-10
Fig. 06	180-712-11
Fig. 07	180-712-12
Fig. 08	180-712-13
Fig. 09	180-712-14
Fig. 10	180-712-15
Fig. 11	180-712-16
Fig. 12	180-712-17

SIMS

31,0 cm, 12¹/₄"



scharf, biegsam
 sharp, malleable
 cortantes, maleable
 acute, malleabile

Fig. 00	180-713-05
Fig. 01	180-713-06
Fig. 02	180-713-07
Fig. 03	180-713-08
Fig. 04	180-713-09
Fig. 05	180-713-10
Fig. 06	180-713-11
Fig. 07	180-713-12
Fig. 08	180-713-13
Fig. 09	180-713-14
Fig. 10	180-713-15
Fig. 11	180-713-16
Fig. 12	180-713-17

SIMS

31,0 cm, 12¹/₄"

Uterusküretten
 Uterine Curettes
 Curetas uterinas
 Curette uterine



30 mm
Fig. 1



35 mm
Fig. 2



40 mm
Fig. 3



scharf, fest
 sharp, rigid
 cortantes, rígidas
 acute, rigide

Fig. 01 180-720-30
 Fig. 2 180-720-35
 Fig. 03 180-720-40

SIMS
 31,0 cm, 12¹/₄"



scharf, biegsam
 sharp, malleable
 cortantes, maleable
 acute, malleabile

Fig. 01 180-721-30
 Fig. 2 180-721-35
 Fig. 03 180-721-40

SIMS
 31,0 cm, 12¹/₄"



30 mm
 Fig. 1



35 mm
 Fig. 2



40 mm
 Fig. 3



scharf, fest
 sharp, rigid
 cortantes, rígidas
 acute, rigide

Fig. 1 **180-722-30**
 Fig. 2 **180-722-35**
 Fig. 3 **180-722-40**

BUMM
 31,0 cm, 12¹/₄"



scharf, biegsam
 sharp, malleable
 cortantes, maleable
 acute, malleabile

Fig. 1 **180-723-30**
 Fig. 2 **180-723-35**
 Fig. 3 **180-723-40**

BUMM
 31,0 cm, 12¹/₄"

Uteruslöffel, Uterus-Biopsiezangen
Uterine Scoopes, Cervical Biopsy and Specimen Forceps
Cucharillas uterinas, Pinzas saca-bocados para biopsia
Curette uterine, Pinze per la biopsia cervicale e da prelievo



BLAKE
 27,0 cm, 10⁵/₈"
180-750-27



SIMON
 25,0 cm, 9³/₄"

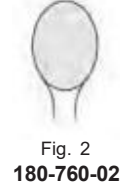
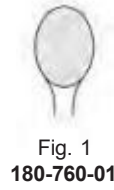

THOMS-GAYLOR
 22,0 cm, 8⁵/₈" **180-680-22**
 24,0 cm, 9¹/₂" **180-680-24**



SCHUBERT
 21,0 cm, 8¹/₄" **180-682-21**
 29,0 cm, 11¹/₂" **180-682-29**



SCHUMACHER-VAN DOREN
 24,0 cm, 9¹/₂"
180-684-24

Uterus-Biopsiezangen
 Cervical Biopsy and Specimen Forceps
 Pinzas saca-bocados para biopsia
 Pinze per la biopsia cervicale e da prelievo



THOMS-GAYLOR
 24,0 cm, 9½"
 180-686-24



FAURE
 21,0 cm, 8¼"
 180-688-21

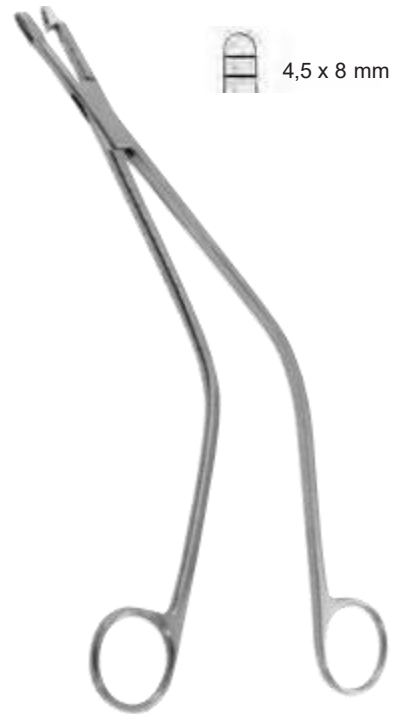

SCHUBERT
 26,0 cm, 10¼"
 180-690-26

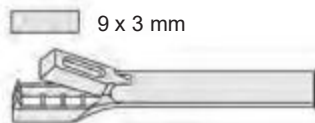

KEVORKIAN
 25,0 cm, 10"
 180-602-25

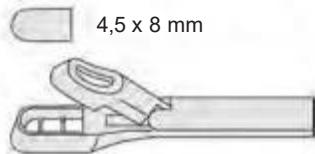

EPPENDORFER
 20,0 cm, 8"
 180-604-20

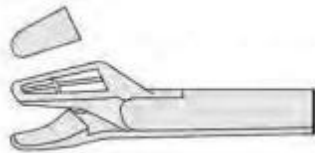

ALEXANDER
 28,0 cm, 11"
 180-608-28

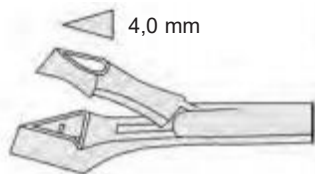

SCHUMACHER
 24,0 cm, 9½"
 180-610-04

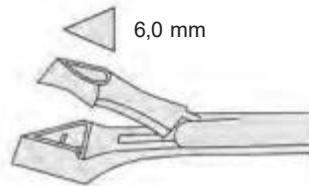

SCHUMACHER
 24,0 cm, 9½"
 180-610-06

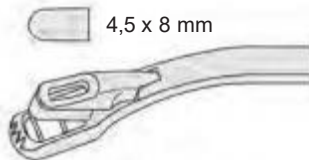

WITTNER
 23,0 cm, 9"
 180-615-23

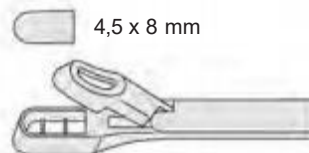

WITTNER
 23,0 cm, 9"
 180-614-23

Uterus-Biopsiezangen
 Cervical Biopsy and Specimen Forceps
 Pinzas saca-bocados para biopsia
 Pinze per la biopsia cervicale e da prelievo

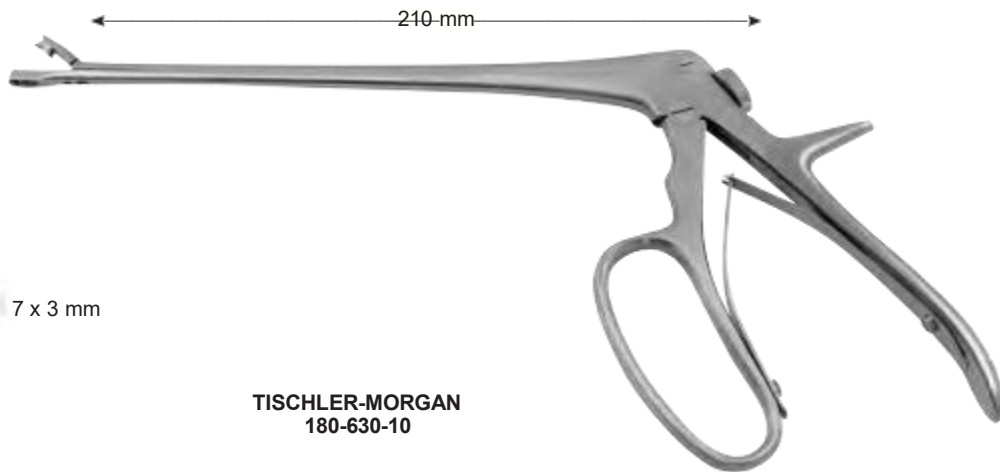
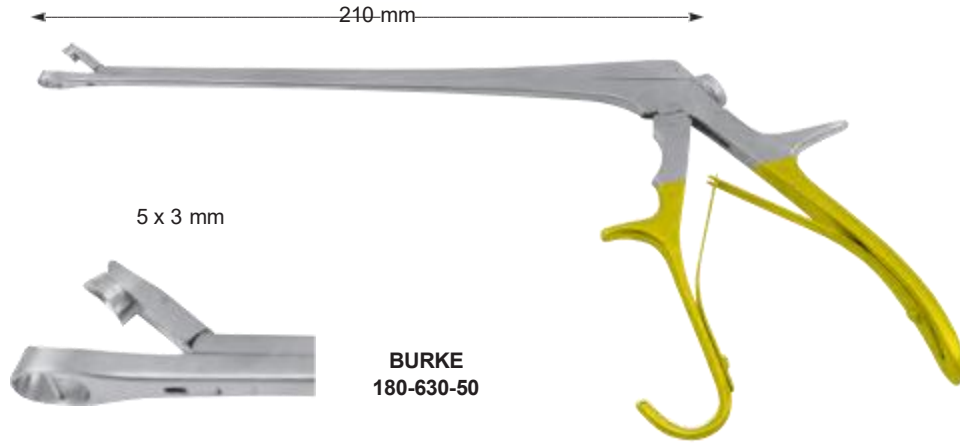

MINI-TOWNSEND
180-630-12

TISCHLER-KEVORKIAN
180-630-41



BABY-TISCHLER
180-630-14

KEVORKIAN-PACIFIC
180-630-40

Geburtszangen
Obstetrical Forceps
Fórceps para obstétrica
Forbici per ostetricia



WRIGLEY
28,0 cm, 11"
181-056-28



SIMPSON
30,0 cm, 11³/₄"
181-034-30



SIMPSON-BRAUN
33,0 cm, 13"
181-036-33



SIMPSON-BRAUN
36,0 cm, 14¹/₈"
181-036-36



SIMPSON-LUIKART
36,0 cm, 14¹/₈"
181-046-36



DE LEE
30,0 cm, 11³/₄"
181-058-30



DE LEE
36,0 cm, 14¹/₈"
181-058-36



DE LEE
38,0 cm, 15³/₈"
181-058-38

Geburtszangen
Obstetrical Forceps
Fórceps para obstétrica
Forbici per ostetricia



MC LEAN
36,0 cm, 14¹/₈"
181-044-36



KIELAND
41,0 cm, 16"
181-052-41



KIELAND-LUIKART
40,0 cm, 15³/₄"
181-054-40



PIPER
44,0 cm, 17¹/₄"
181-060-44



ELLIOT
32,0 cm, 12¹/₂"
181-080-32



ELLIOT
38,0 cm, 15"
181-080-38



NAEGELE
36,0 cm, 14¹/₈"
181-084-36



NAEGELE
40,0 cm, 15³/₄"
181-084-40

Geburtszangen, Plazentar- und Abortuszangen
 Obstetrical Forceps, Placenta and Ovum Forceps
 Fórceps para obstétrica, Pinzas para aborto y placenta
 Forbici per ostetricia, Pinze per placenta e per ovaie



GREEN-ARMYTAGE
 21,0 cm, 8¹/₄"
 181-200-21



PESTALOZZA
 30,0 cm, 11³/₄"
 181-252-30



SAENGER
 27,0 cm, 10⁵/₈"
 181-260-27



SAENGER
 27,0 cm, 10⁵/₈"
 181-261-27



WINTER
 28,0 cm, 11"



Fig. 1
 181-244-01



Fig. 2
 181-244-02



Fig. 3
 181-244-03



Fig. 1
 181-245-01



Fig. 2
 181-245-02



Fig. 3
 181-245-03

Plazentar- und Abortuszangen
 Placenta and Ovum Forceps
 Pinzas para aborto y placenta
 Pinze per placenta e per ovaie



WALICH
 42,0 cm, 16 1/2"
 181-300-42



MARTIN
 34,0 cm, 13 3/8"
 181-600-34



gerade
 straight
 recto
 retto

BIERER
 33,0 cm, 13"
 58-1236-01



gerade
 straight
 recto
 retto

BIERER
 33,0 cm, 13"
 181-236-02



gebogen
 curved
 curvo
 curvo

BIERER
 33,0 cm, 13"
 181-237-01



gebogen
 curved
 curvo
 curvo

BIERER
 33,0 cm, 13"
 181-237-02



Vorbereitung, Dermatologie
Preparation, Dermatology
Preparación, Dermatología
Preparazione, Dermatologia



Hautstanzen, Nagel Instrumente
 Dermal Punches, Nail Instruments
 Trépanos cutáneos, Instrumentos para uñas
 Trapani dermatici, Strumenti per unghie



PIFFARD
 14,0 cm, 5³/₄"

Lupusküretten
 Lupus curettes
 Curetas para lupus
 Raschiatoio per lupus



3 mm
186-110-03



4 mm
186-110-04



5 mm
186-110-05



KEYES
 12,0 cm, 4³/₄"



2 mm
186-200-02



3 mm
186-200-03



4 mm
186-200-04



5 mm
186-200-05



6 mm
186-200-06



7 mm
186-200-07



8 mm
186-200-08



KEYES
 12,0 cm, 4³/₄"
186-210-00



186-400-00
 komplett, complete,
 completo, completo,



186-400-01



186-400-02



186-400-03

Komedonenquetscher
Comedo Extractors
Saca-comedones
Tiracomedoni



UNNA
14,0 cm, 5³/₄"
186-000-14



UNNA
14,0 cm, 5³/₄"
186-002-14



SAALFELD
10,0 cm, 4"
186-010-10



SAALFELD
14,0 cm, 5³/₄"
186-012-14



SCHAMBERG
10,0 cm, 4"
186-020-10



WALTON
14,0 cm, 5³/₄"
186-030-14



FOX
14,0 cm, 5³/₄"



3 mm
186-100-03



4 mm
186-100-04



5 mm
186-100-05



6 mm
186-100-06

Lupusküretten
Lupus curettes
Curetas para lupus
Raschiatoio per lupus

Nagel Instrumente
Nail Instruments
Instrumentos para uñas
Strumenti per unghie



186-420-01

17,0 cm, 6³/₄"
 186-420-17



186-430-01

WALTON
 16,0 cm, 6¹/₄"
 186-430-16



RADOLF
 13,5 cm, 5³/₈"
 186-500-13



13,5 cm, 5³/₈"
 186-510-13



13,0 cm, 5"
 186-600-13



186-610-01



186-610-02

14,0 cm, 5¹/₂"



Knochenchirurgie
Bone Surgery
Cirurgía ósea
Chirurgia ossea

Scharfe Löffel
 Bone Currettes
 Cucharillas cortantes
 Curetta per ossa



SCHEDE
 17,0 cm, 6³/₄"

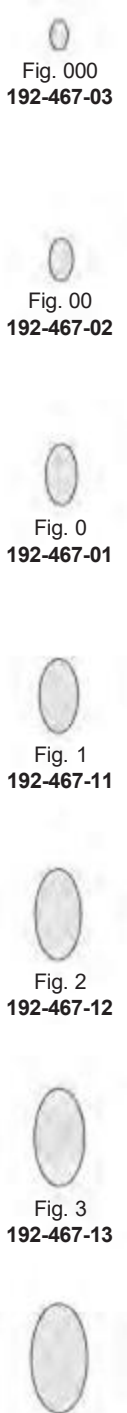

Fig. 000
 192-467-03

Fig. 00
 192-467-02

Fig. 0
 192-467-01

Fig. 1
 192-467-11

Fig. 2
 192-467-12

Fig. 3
 192-467-13

Fig. 4
 192-467-14



VOLKMANN
 17,0 cm, 6³/₄"



Fig. 0000
 192-469-04

Fig. 000
 192-469-03

Fig. 00
 192-469-02

Fig. 0
 192-469-01

Fig. 1
 192-469-11

Fig. 2
 192-469-12

Fig. 3
 192-469-13

Fig. 4
 192-469-14

Fig. 5
 192-469-15

Fig. 6
 192-469-16



BRUNS
 17,0 cm, 6³/₄"



Fig. 0000
 192-472-04

Fig. 000
 192-472-03

Fig. 00
 192-472-02

Fig. 0
 192-472-01

Fig. 1
 192-472-11

Fig. 2
 192-472-12

Fig. 3
 192-472-13

Fig. 4
 192-472-14

Fig. 5
 192-472-15

Fig. 6
 192-472-16

Scharfe Löffel
 Bone Curettes
 Cucharillas cortantes
 Curetta per ossa

Fig. 00000
 192-448-04

Fig. 0000
 192-448-03

Fig. 000
 192-448-02

Fig. 00
 192-448-01

Fig. 0
 192-448-00



LEMPERT
 21,5 cm, 8½"



HALLE
 21,0 cm, 8¼"

Fig. 00
 192-452-02

Fig. 0
 192-452-01

Fig. 1
 192-452-11



DAUBENSPECK
 20,0 cm, 8"

Fig. 00
 192-487-02

Fig. 0
 192-487-01

Fig. 1
 192-487-11

Fig. 2
 192-487-12

Scharfe Löffel
 Bone Curettes
 Cucharillas cortantes
 Curetta per ossa



WILLIGER
 17,0 cm, 6³/₄"



Fig. 1
 192-430-11



Fig. 2
 192-430-12



WILLIGER
 14,0 cm, 5¹/₂"



Fig. 0
 192-406-00



Fig. 1
 192-406-01



Fig. 2
 192-406-02



MARTINI
 14,0 cm, 5¹/₂"
 192-408-00



Fig. 00/0
 192-408-00
 14,0 cm, 5¹/₂"



Fig. 0/1
 192-408-01
 14,0 cm, 5¹/₂"



Fig. 1/2
 192-408-12
 14,0 cm, 5¹/₂"



VOLKMANN



192-414-13
 13,0 cm, 5"



192-414-14
 14,0 cm, 5¹/₂"



192-414-17
 17,0 cm, 6³/₄"

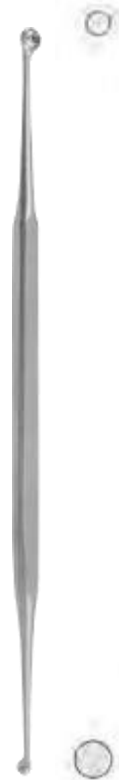

JANSEN
 16,0 cm, 6¹/₄"
 192-410-16



Dissektoren, Elevatorien
 Dissectors, Elecators
 Disecadores, Elevadores
 Dissettori, Elevatori

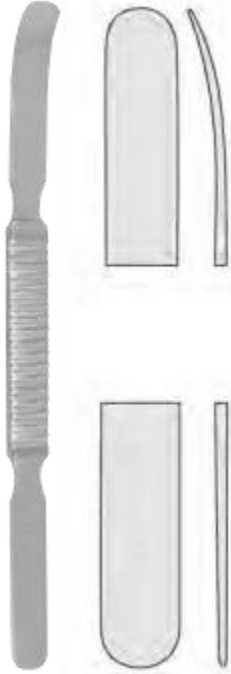

WATSON-CHEYNE
 17,5 cm, 6⁵/₈"
 193-501-17



MC DONALD
 19,0 cm, 7¹/₂"
 193-440-19



WILLIGER
 17,0 cm, 6³/₄"
 193-512-17



WILLIGER
 16,0 cm, 6¹/₄"
 193-512-16



LANGENBECK
 20,0 cm, 8"
 193-520-08



LANGENBECK
 20,0 cm, 8"
 193-520-10

Raspatorien
 Raspatories
 Periostótomos
 Periostotomi



ADSON
 17,0 cm, 6¾"



8 mm
 193-465-01



7 mm
 193-465-02



7 mm
 193-465-03



7 mm
 193-465-04



KÖNIG
 15,5 cm, 6"
 193-476-15

5 mm

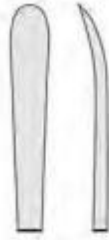

LAMBOTTE
 21,0 cm, 8¼"



10 mm
 193-477-10



15 mm
 193-477-15



20 mm
 193-477-20



25 mm
 193-477-25

12,5 mm



FARABEUF
 15,0 cm, 6"
 193-478-15



Raspatorien
Raspatories
Periostótomos
Periostotomi

12,5 mm

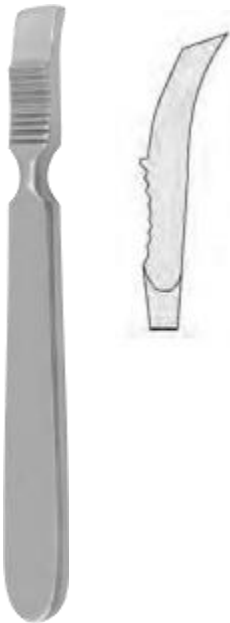

FARABEUF
15,0 cm, 6"
193-479-15

16,0 mm



LANGENBECK
19,0 cm, 7 1/2"
193-472-19

15,0 mm



SEDILLOT
21,0 cm, 8 1/4"
193-488-21



WILLIGER
16,0 cm, 6 1/4"

4 mm	193-480-04
6 mm	193-480-06
8 mm	193-480-08



für Kinder
for children
para niños
per bambini

DOYEN
17,0 cm, 6 3/4"
193-485-17



für Kinder
for children
para niños
per bambini

DOYEN
17,0 cm, 6 3/4"
193-487-17



für Erwachsene
for adults
para adultos
per adulti д.п

DOYEN
17,0 cm, 6 3/4"
193-481-17



für Erwachsene
for adults
para adultos
per adulti

DOYEN
17,0 cm, 6 3/4"
193-483-17

Flachmeißel, Hohlmeißel, Osteotome
 Chisels, Gouges, Osteotomes
 Cinceles, Gubias, Osteótomos
 Scalpelli, Sgorbie, Osteotomi

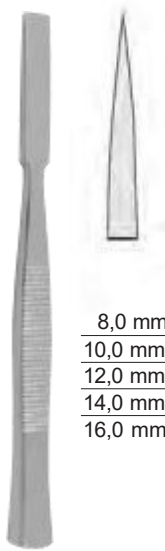

8,0 mm	194-300-08
10,0 mm	194-300-10
12,0 mm	194-300-12
14,0 mm	194-300-14
16,0 mm	194-300-16

13,5 cm, 5³/₈"

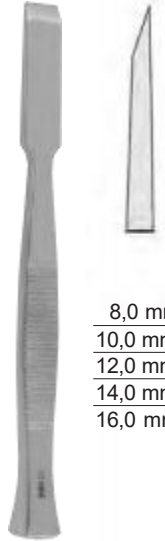

8,0 mm	194-301-08
10,0 mm	194-301-10
12,0 mm	194-301-12
14,0 mm	194-301-14
16,0 mm	194-301-16

13,5 cm, 5³/₈"

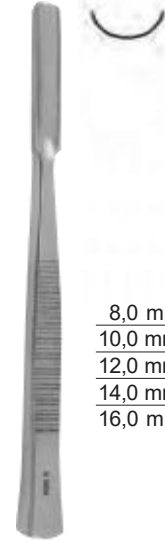

8,0 mm	194-302-08
10,0 mm	194-302-10
12,0 mm	194-302-12
14,0 mm	194-302-14
16,0 mm	194-302-16

13,5 cm, 5³/₈"



3,0 mm	194-334-03
4,0 mm	194-334-04
5,0 mm	194-334-05
6,0 mm	194-334-06

PARTSCH
13,5 cm, 5³/₈"



3,0 mm	194-336-03
4,0 mm	194-336-04
5,0 mm	194-336-05
6,0 mm	194-336-06

PARTSCH
13,5 cm, 5³/₈"



10,0 mm	194-361-10
15,0 mm	194-361-15
20,0 mm	194-361-20
25,0 mm	194-361-25

STILLE
20,0 cm, 8"

Flachmeißel, Hohlmeißel, Osteotome
 Chisels, Gouges, Osteotomes
 Cinceles, Gubias, Osteótomos
 Scalpelli, Sgorbie, Osteotomi



10,0 mm	194-360-10
15,0 mm	194-360-15
20,0 mm	194-360-20
25,0 mm	194-360-25

STILLE
 20,0 cm, 8"



10,0 mm	194-362-10
15,0 mm	194-362-15
20,0 mm	194-362-20
25,0 mm	194-362-25

STILLE
 20,0 cm, 8"

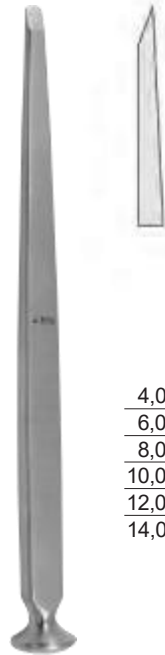

4,0 mm	194-318-04
6,0 mm	194-318-06
8,0 mm	194-318-08
10,0 mm	194-318-10
12,0 mm	194-318-12
14,0 mm	194-318-14

ALEXANDER
 18,0 cm, 7"



4,0 mm	194-319-04
6,0 mm	194-319-06
8,0 mm	194-319-08
10,0 mm	194-319-10
12,0 mm	194-319-12
14,0 mm	194-319-14

ALEXANDER
 18,0 cm, 7"



6,0 mm	194-350-06
9,0 mm	194-350-09
13,0 mm	194-350-13
16,0 mm	194-350-16
19,0 mm	194-350-19
25,0 mm	194-350-25
32,0 mm	194-350-32

SMITH-PETERSEN
 20,0 cm, 8"



6,0 mm	194-351-06
9,0 mm	194-351-09
13,0 mm	194-351-13
16,0 mm	194-351-16
19,0 mm	194-351-19
25,0 mm	194-351-25
32,0 mm	194-351-32

SMITH-PETERSEN
 20,0 cm, 8"

Flachmeißel, Hohlmeißel, Osteotome, Hämmer
 Chisels, Gouges, Osteotomes, Mallets
 Cinceles, Gubias, Osteótomos, Martillos
 Scalpelli, Sgorbie, Osteotomi, Martelli



9,0 mm	194-352-09
14,0 mm	194-352-14
16,0 mm	194-352-16
19,0 mm	194-352-19
25,0 mm	194-352-25

SMITH-PETERSEN
20,0 cm, 8"



9,0 mm	194-353-09
14,0 mm	194-353-14
16,0 mm	194-353-16
19,0 mm	194-353-19
25,0 mm	194-353-25

SMITH-PETERSEN
20,0 cm, 8"



6,0 mm	194-450-06
15,0 mm	194-450-15
20,0 mm	194-450-20
25,0 mm	194-450-25
30,0 mm	194-450-30
38,0 mm	194-450-38
44,0 mm	194-450-44
50,0 mm	194-450-50

LAMBOTTE
24,0 cm, 9½"

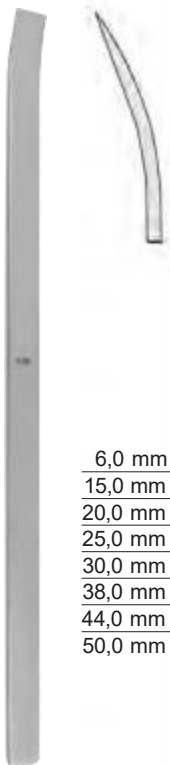

6,0 mm	194-451-06
15,0 mm	194-451-15
20,0 mm	194-451-20
25,0 mm	194-451-25
30,0 mm	194-451-30
38,0 mm	194-451-38
44,0 mm	194-451-44
50,0 mm	194-451-50

LAMBOTTE
24,0 cm, 9½"



COLLIN
20,0 cm, 8"
191-132-20



PARTSCH
18,0 cm, 7"
191-145-18

mit Bleifüllung
lead filled head
cabezalrellenode plomo
testa dipiombo



BERGMANN
24,0 cm, 9½"
191-201-24



RISH SURGICAL

NAME OF TRUST

Sterilisation
Sterilization
Esterilización
Sterilizzazione

Sterilisierzangen
Sterilizing Forceps
Pinzas para esterilización
Pinze per sterilizzazione



20,0 cm, 8"
250-160-20



CHEATTLE
27,0 cm, 10⁵/₈"
250-163-27



ROGGE
23,0 cm, 9"
250-164-23



MAYO
14,0 cm, 5¹/₂"
250-151-14



BUNT
12,0 cm, 4³/₄"
250-154-12



Ø 75 x 130 mm	250-142-06
Ø 75 x 175 mm	250-142-07
Ø 100 x 175 mm	250-142-08
Ø 100 x 200 mm	250-142-09



Ø 40,0 mm	250-130-04
Ø 60,0 mm	250-130-06
Ø 80,0 mm	250-130-08
Ø 100,0 mm	250-130-10
Ø 120,0 mm	250-130-12
Ø 150,0 mm	250-130-15



65 x 55 mm	0,75 l	250-133-00
75 x 70 mm	1,00 l	250-133-10
225 x 100 mm	2,00 l	250-133-20
240 x 95 mm	2,75 l	250-133-30
260 x 120 mm	4,00 l	250-133-40
290 x 100 mm	5,00 l	250-133-50
315 x 150 mm	5,50 l	250-133-60
325 x 135 mm	8,00 l	250-133-70
360 x 165 mm	12,00 l	250-133-80
415 x 150 mm	14,00 l	250-133-90



170 mm	250-140-17
250 mm	250-140-25

Schalen
Trays
Bandejas
Bacinelle



200 x 150 x 25 mm **250-200-01**
 260 x 180 x 30 mm **250-200-02**
 300 x 220 x 30 mm **250-200-03**
 350 x 220 x 40 mm **250-200-04**
 220 x 170 x 50 mm **250-200-05**
 280 x 200 x 50 mm **250-200-06**
 320 x 240 x 50 mm **250-200-07**
 370 x 270 x 50 mm **250-200-08**
 420 x 320 x 50 mm **250-200-09**

250-300-00
 Ø 65 x 17 mm
 Außen- und Innendose
 Exterior and interior box
 Caja exterior e interior
 Scatola esterna es interiore

250-300-01
 Ø 62 x 13 mm
 Innendose allein
 Interior box only
 Caja interior, suelta
 Scatola interioresola



25 ccm
250-310-25



50 ccm
250-310-50

**Bürstenspender
Brush Dispensers
Distribuidores de cepillos
Distributori di spazzole**



Bürstenspender für 10 Bürsten
Brush dispenser for 10 brushes
Distribuidor de cepillos para 10 cepillos
Distributore per 10 spazzole
260 x 155 x 65 mm
250-800-01

Bürstenspender für 20 Bürsten
Brush dispenser for 20 brushes
Distribuidor de cepillos para 20 cepillos
Distributore per 20 spazzole
270 x 240 x 65 mm
250-800-02

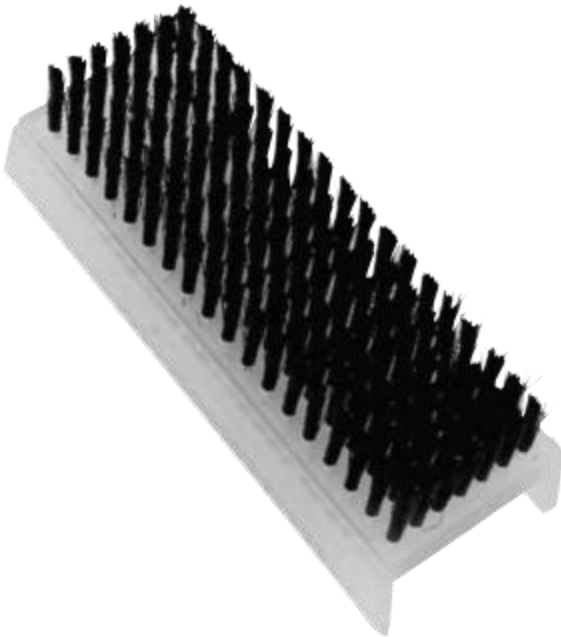

250-800-10

mehrs 400x autoklavierbar
more than 400 times autoclavable
esterilizable más de 400 veces en autoclave
sterilizzabile più di 400 volte in autoclave



Index nummerisch
Index numerical

Index numerisch
Index numerical

003-003-00	2	003-250-17	8	010-052-12	16	010-114-23	22
003-003-01	2	003-250-20	8	010-052-13	16	010-114-25	22
003-003-02	2	003-250-22	8	010-052-14	16	010-114-28	22
003-004-00	3	003-400-19	11	010-053-12	16	010-114-30	22
003-004-01	3	003-401-19	11	010-053-13	16	010-115-14	20
003-007-00	2	003-410-30	11	010-053-14	16	010-115-18	22
003-007-01	2	003-411-30	11	010-054-12	16	010-115-20	22
003-008-00	3	003-412-35	11	010-054-13	16	010-115-23	22
003-009-00	3	003-413-35	11	010-054-14	16	010-115-25	22
003-050-10	4	003-420-30	11	010-055-12	16	010-115-28	22
003-050-11	4	003-421-30	11	010-055-13	16	010-115-30	22
003-050-11S	4	003-422-30	10	010-055-14	16	010-120-14	22
003-050-12	4	010-000-10	14	010-070-13	17	010-120-18	22
003-050-12D	4	010-000-11	14	010-070-14	17	010-120-20	22
003-050-13	4	010-000-13	14	010-071-13	17	010-120-23	22
003-050-15	4	010-000-14	14	010-071-14	17	010-120-25	22
003-050-15C	4	010-000-15	14	010-072-13	17	010-120-28	22
003-050-18	5	010-000-16	14	010-072-14	17	010-120-30	22
003-050-19	5	010-000-17	14	010-073-13	17	010-121-14	22
003-050-20	5	010-000-18	14	010-073-14	17	010-121-18	23
003-050-21	5	010-000-20	14	010-074-13	18	010-121-20	23
003-050-22	5	010-001-10	14	010-074-14	18	010-121-23	23
003-050-23	5	010-001-11	14	010-075-13	18	010-121-25	23
003-050-24	5	010-001-13	14	010-075-14	18	010-121-28	23
003-050-25	5	010-001-14	14	010-100-14	18	010-121-30	23
003-060-10	6	010-001-15	14	010-100-17	18	010-124-18	23
003-060-12	6	010-001-16	14	010-100-23	18	010-124-20	23
003-060-14	6	010-001-17	14	010-100-28	18	010-124-23	23
003-060-16	6	010-001-18	14	010-101-14	18	010-124-25	23
003-060-18	6	010-001-20	14	010-101-17	18	010-124-28	23
003-066-01	6	010-002-10	14	010-101-23	18	010-124-30	23
003-066-02	6	010-002-11	14	010-101-28	18	010-125-18	23
003-066-03	6	010-002-13	14	010-102-15	19	010-125-20	23
003-066-04	6	010-002-14	14	010-102-17	19	010-125-23	23
003-066-05	6	010-002-15	14	010-102-19	19	010-125-25	23
003-066-06	6	010-002-16	14	010-102-21	19	010-125-28	23
003-070-01	7	010-002-17	14	010-103-15	19	010-125-30	23
003-070-02	7	010-002-18	14	010-103-17	19	010-127-18	24
003-070-03	7	010-002-20	14	010-103-19	19	010-127-20	24
003-070-04	7	010-003-10	14	010-103-21	19	010-127-23	24
003-070-05	7	010-003-11	14	010-104-17	19	010-129-18	24
003-070-06	7	010-003-13	14	010-105-17	19	010-129-20	24
003-070-07	7	010-003-14	14	010-110-11	20	010-129-23	24
003-070-08	7	010-003-15	14	010-110-14	20	010-137-14	24
003-070-09	7	010-003-16	14	010-110-18	21	010-139-17	24
003-070-10	7	010-003-17	14	010-110-20	21	010-140-10	25
003-076-01	7	010-003-18	14	010-110-23	21	010-140-16	25
003-076-02	7	010-003-20	14	010-110-25	21	010-140-21	25
003-076-03	7	010-004-10	15	010-110-28	21	010-141-10	25
003-076-04	7	010-004-11	15	010-110-30	21	010-141-16	25
003-076-05	7	010-004-13	15	010-111-11	20	010-141-21	25
003-076-06	7	010-004-14	15	010-111-14	20	010-160-17	25
003-076-07	7	010-004-15	15	010-111-18	21	010-161-17	25
003-076-08	7	010-004-16	15	010-111-20	21	010-200-12	26
003-076-09	7	010-004-17	15	010-111-23	21	010-200-15	26
003-078-15	7	010-004-18	15	010-111-25	21	010-200-18	26
003-078-16	7	010-004-20	15	010-111-28	21	010-200-20	26
003-080-13	8	010-005-10	15	010-111-30	21	010-201-12	26
003-080-16	8	010-005-11	15	010-112-18	21	010-201-15	26
003-080-19	8	010-005-13	15	010-112-20	21	010-201-18	26
003-080-22	8	010-005-14	15	010-112-23	21	010-201-20	26
003-080-28	8	010-005-15	15	010-112-25	21	010-210-15	26
003-082-16	8	010-005-16	15	010-112-28	21	010-210-18	26
003-082-19	8	010-005-17	15	010-112-30	21	010-211-15	26
003-082-22	8	010-005-18	15	010-113-14	20	010-211-18	26
003-105-55	10	010-005-20	15	010-113-18	21	010-211-20	26
003-110-65	10	010-009-13	19	010-113-20	21	010-211-23	26
003-150-11	9	010-050-12	15	010-113-23	21	010-211-25	26
003-150-14	9	010-050-13	15	010-113-25	21	010-217-19	27
003-150-17	9	010-050-14	15	010-113-28	21	010-217-25	27
003-180-16	9	010-051-12	15	010-113-30	21	010-220-15	27
003-180-20	9	010-051-13	15	010-114-18	22	010-221-15	27
003-180-24	9	010-051-14	15	010-114-20	22	010-224-14	27

010-400-09	33	010-622-22	40	011-100-14	47	011-125-14	49
010-400-10	33	010-634-16	40	011-100-17	47	011-125-18	50
010-400-13	33	010-634-18	40	011-100-23	47	011-125-20	50
010-402-11	33	010-635-16	41	011-101-14	47	011-125-23	50
010-402-14	33	010-635-18	41	011-101-17	47	011-125-25	50
010-404-14	33	010-640-19	41	011-101-23	47	011-125-28	50
010-404-18	33	010-640-23	41	011-102-15	47	011-125-30	50
010-408-16	34	010-650-18	41	011-102-17	47	011-127-18	51
010-413-13	34	010-651-18	41	011-110-11	48	011-127-20	51
010-415-12	34	010-670-21	41	011-110-14	48	011-127-23	51
010-450-22	34	010-672-21	41	011-110-18	48	011-129-18	51
010-453-17	34	010-674-21	41	011-110-20	48	011-129-20	51
010-457-17	35	010-677-27	41	011-110-23	48	011-129-23	51
010-458-17	35	010-680-31	42	011-110-25	48	011-137-14	50
010-459-17	35	010-681-31	42	011-110-28	48	011-139-17	50
010-501-18	35	010-685-32	42	011-110-30	48	011-140-16	47
010-511-16	35	010-688-25	42	011-111-11	48	011-140-21	47
010-517-18	35	010-688-28	42	011-111-14	48	011-141-16	47
010-519-22	35	010-689-25	42	011-111-18	48	011-141-21	47
010-521-18	36	010-689-28	42	011-111-20	48	011-210-15	51
010-523-17	36	010-691-19	42	011-111-23	48	011-211-15	51
010-525-19	36	010-693-27	42	011-111-25	48	011-244-11	55
010-528-20	36	010-695-18	43	011-111-28	48	011-245-11	55
010-540-25	36	010-701-14	43	011-111-30	48	011-543-25	53

Index numerisch
Index numerical

011-543-45	53	018-232-15Z	61	020-010-25	64	020-206-30	71
011-543-60	53	018-241-14Z	59	020-010-30	64	020-208-15	72
011-545-25	53	018-241-16Z	59	020-011-10	65	020-209-15	72
011-545-45	53	018-243-14	59	020-011-11	65	020-210-13	70
011-545-60	53	018-243-16	59	020-011-13	65	020-210-14	70
011-548-24	53	018-246-01	59	020-011-14	65	020-210-15	70
011-550-25	54	018-246-02	59	020-011-16	65	020-210-16	70
011-550-45	54	018-246-03	59	020-011-18	65	020-210-18	70
011-550-60	54	018-270-12	60	020-011-20	65	020-210-20	70
011-550-90	54	018-270-25	60	020-011-25	65	020-210-25	70
011-551-25	54	018-270-45	60	020-011-30	65	020-210-30	70
011-551-40	54	018-270-60	60	020-012-13	65	020-212-12	71
011-551-60	54	018-270-90	60	020-012-14	65	020-212-13	71
011-552-17	53	018-271-12	60	020-012-15	65	020-212-14	71
011-600-20	52	018-271-25	60	020-012-18	65	020-212-15	71
011-600-23	52	018-271-45	60	020-012-20	65	020-212-18	71
011-601-20	52	018-271-60	60	020-012-25	65	020-212-20	71
011-601-23	52	018-271-90	60	020-018-10	65	020-212-25	71
011-602-20	52	018-290-01	59	020-018-11	65	020-212-30	71
011-602-23	52	018-290-02	59	020-018-13	65	020-218-13	70
011-603-20	52	018-290-03	59	020-018-14	65	020-218-14	70
011-603-23	52	018-290-04	59	020-018-16	65	020-218-15	70
011-604-20	52	018-291-01	59	020-018-18	65	020-218-16	70
011-604-23	52	018-291-02	59	020-018-20	65	020-218-18	70
011-605-20	52	018-291-03	59	020-018-25	65	020-218-20	70
011-605-23	52	018-291-04	59	020-018-30	65	020-218-25	70
011-663-25	51	018-292-01	59	020-026-18	67	020-218-30	70
011-665-25	51	018-292-02	59	020-026-21	67	020-219-13	70
011-800-12	55	018-293-01	59	020-026-25	67	020-219-14	70
011-900-18	55	018-293-02	59	020-027-18	67	020-219-16	70
011-909-24	55	020-002-10	64	020-027-21	67	020-219-18	70
012-100-17	56	020-002-11	64	020-027-25	67	020-219-20	70
012-101-17	56	020-002-13	64	020-036-13	67	020-226-18	74
012-110-11	57	020-002-14	64	020-036-14	67	020-226-21	74
012-110-14	57	020-002-15	64	020-036-15	67	020-226-25	74
012-111-14	56	020-002-16	64	020-040-12	67	020-227-18	74
012-111-18	56	020-002-18	64	020-040-15	67	020-227-21	74
012-111-20	56	020-002-20	64	020-070-12	66	020-227-25	74
012-111-23	56	020-002-25	64	020-070-15	66	020-236-13	70
012-121-14	56	020-002-30	64	020-076-12	66	020-236-14	70
012-121-18	56	020-003-10	64	020-076-15	66	020-236-15	70
012-121-20	56	020-003-11	64	020-092-17	67	020-240-12	73
012-121-23	56	020-003-13	64	020-093-17	67	020-240-15	73
012-129-15	56	020-003-14	64	020-094-20	67	020-242-12	73
012-129-19	56	020-003-16	64	020-095-20	68	020-252-11	69
012-130-13	56	020-003-18	64	020-102-18	66	020-252-13	69
012-133-18	56	020-003-20	64	020-103-18	67	020-252-14	69
012-139-17	56	020-003-25	64	020-114-17	66	020-252-16	69
012-200-12	58	020-003-30	64	020-115-17	66	020-252-18	69
012-201-12	58	020-004-10	64	020-117-18	66	020-252-20	69
012-210-12	57	020-004-11	64	020-120-18	68	020-252-25	69
012-218-15	57	020-004-13	64	020-126-20	68	020-252-30	69
012-218-18	57	020-004-14	64	020-130-15	68	020-254-13	69
012-240-11	57	020-004-16	64	020-130-20	68	020-254-14	69
012-241-11	57	020-004-18	64	020-136-18	68	020-254-16	69
012-244-11	57	020-004-20	64	020-158-15	66	020-254-18	69
012-245-11	57	020-004-25	64	020-200-10	69	020-254-20	69
012-290-11	57	020-004-30	64	020-200-11	69	020-256-13	69
012-291-11	57	020-006-13	65	020-200-13	69	020-256-14	69
012-343-15	58	020-006-14	65	020-200-14	69	020-256-16	69
012-511-16	58	020-006-15	65	020-200-15	69	020-256-18	69
012-551-25	58	020-006-18	65	020-200-16	69	020-256-20	69
012-551-45	58	020-006-20	65	020-200-18	69	020-270-12	71
012-551-60	58	020-006-25	65	020-200-20	69	020-270-15	71
018-081-11	59	020-006-30	65	020-200-25	69	020-276-12	71
018-083-11	59	020-008-15	66	020-200-30	69	020-276-15	71
018-201-15	60	020-010-10	64	020-206-12	71	020-282-12	72
018-201-18	60	020-010-11	64	020-206-13	71	020-288-12	72
018-203-15	61	020-010-13	64	020-206-14	71	020-288-15	72
018-203-18	61	020-010-14	64	020-206-15	71	020-292-17	74
018-223-15	60	020-010-16	64	020-206-18	71	020-293-17	74
018-223-15Z	60	020-010-18	64	020-206-20	71	020-294-20	74
018-232-15	61	020-010-20	64	020-206-25	71	020-295-20	74

020-300-15	72	020-663-11	77	021-140-25	82	030-160-18	90
020-302-18	73	020-663-13	77	021-158-15	83	030-160-20	90
020-303-18	73	020-663-14	77	021-200-14	82	030-160-25	90
020-314-17	73	020-666-08	77	021-200-18	82	030-161-18	90
020-315-17	73	020-666-09	77	021-200-20	82	030-161-20	90
020-317-17	73	020-666-10	77	021-200-25	82	030-161-25	90
020-330-15	74	020-666-11	77	021-270-12	83	030-170-18	90
020-330-20	74	020-666-13	77	021-270-15	83	030-170-20	90
020-358-15	73	020-666-14	77	021-300-15	83	030-170-25	90
020-382-15	72	020-667-08	77	021-302-17	83	030-171-18	90
020-382-20	72	020-667-09	77	021-590-17	83	030-171-20	90
020-384-15	72	020-667-10	77	026-014-03	94	030-171-25	90
020-384-20	72	020-667-11	77	026-014-05	94	030-180-25	90
020-410-15	76	020-667-13	77	026-015-03	94	030-181-25	90
020-410-20	76	020-667-14	77	026-015-05	94	030-190-18	90
020-410-25	76	020-700-16	81	026-018-04	94	030-190-25	90
020-420-14	76	020-700-20	81	026-018-05	94	030-200-22	89
020-420-20	76	020-700-24	81	026-018-06	94	030-200-25	89
020-422-14	76	020-700-30	81	026-018-07	94	030-200-27	89
020-422-20	76	020-701-16	81	026-018-09	94	030-201-22	89
020-456-15	74	020-701-20	81	026-019-04	94	030-201-25	89
020-456-20	74	020-701-24	81	026-019-05	94	030-201-27	89
020-456-25	74	020-701-30	81	026-019-06	94	030-210-20	90
020-460-14	75	020-702-16	81	026-019-07	94	030-210-22	90
020-460-16	75	020-702-20	81	026-019-09	94	030-210-25	90
020-460-20	75	020-702-24	81	026-292-07	95	030-210-27	90
020-470-12	75	020-702-30	81	026-292-08	95	030-211-20	90
020-470-20	68	020-703-16	81	026-292-10	95	030-211-22	90
020-470-23	75	020-703-20	81	026-292-12	95	030-211-25	90
020-470-34	75	020-703-24	81	026-293-07	95	030-211-27	90
020-494-01	75	020-703-30	81	026-293-08	95	030-300-25	89
020-494-02	75	020-704-16	81	026-293-10	95	030-303-25	89
020-494-03	75	020-704-20	81	026-293-12	95	030-310-25	89
020-510-13	76	020-704-24	81	026-295-23	94	030-311-25	89
020-510-15	76	020-704-30	81	026-298-07	96	030-320-26	88
020-516-23	68	020-706-16	81	026-298-09	96	030-321-26	89
020-518-15	75	020-706-20	81	026-298-11	96	030-351-13	88
020-518-20	75	020-706-24	81	026-299-06	96	030-360-13	88
020-518-23	75	020-706-30	81	026-299-09	96	030-360-16	88
020-520-18	76	020-708-16	81	026-299-11	96	030-360-18	88
020-522-18	76	020-708-20	81	026-520-01	94	032-002-15	91
020-586-14	75	020-708-24	81	026-520-02	94	032-002-18	91
020-587-14	75	020-708-30	81	027-032-35	95	032-002-20	91
020-590-18	76	020-716-16	81	027-032-40	95	032-004-15	91
020-592-18	76	020-716-20	81	027-033-35	95	032-004-18	91
020-601-03	80	020-716-24	81	027-033-40	95	032-004-20	91
020-601-04	80	020-716-30	81	027-042-35	95	032-006-14	91
020-601-05	80	020-718-16	81	027-042-40	95	032-012-16	91
020-601-07	80	020-718-20	81	027-043-35	95	032-012-18	91
020-620-01	80	020-718-24	81	027-043-40	95	032-012-20	91
020-620-02	80	020-718-30	81	030-000-09	86	040-000-10	99
020-620-03	80	020-806-10	78	030-000-11	86	040-001-10	99
020-620-04	80	020-807-10	78	030-000-13	86	040-010-10	98
020-634-12	81	020-809-10	78	030-000-15	86	040-016-10	98
020-634-13	81	020-810-10	79	030-005-11	86	040-020-10	101
020-635-13	81	020-811-10	79	030-010-13	86	040-020-12	101
020-637-13	81	020-813-10	79	030-010-15	87	040-021-10	101
020-650-07	78	020-814-10	79	030-014-10	87	040-021-12	101
020-650-09	78	020-815-10	79	030-014-13	87	040-030-10	101
020-650-11	78	020-817-10	79	030-020-10	88	040-030-12	101
020-652-10	78	021-026-15	83	030-020-13	88	040-031-10	101
020-653-10	78	021-026-18	83	030-024-13	87	040-031-12	101
020-656-10	78	021-026-20	83	030-030-14	88	040-050-12	100
020-657-10	78	021-040-12	82	030-040-15	87	040-050-14	100
020-662-08	77	021-040-15	82	030-040-18	87	040-050-18	100
020-662-09	77	021-070-12	83	030-040-20	87	040-050-21	100
020-662-10	77	021-070-15	83	030-044-16	87	040-051-12	100
020-662-11	77	021-092-17	83	030-101-09	86	040-051-14	100
020-662-13	77	021-093-17	83	030-105-05	86	040-051-18	100
020-662-14	77	021-102-17	83	030-105-07	86	040-051-21	100
020-663-08	77	021-117-18	83	030-105-09	86	040-070-12	100
020-663-09	77	021-140-15	82	030-107-09	86	040-070-14	100
020-663-10	77	021-140-23	82	030-109-09	86	040-070-18	100

Index numerisch
Index numerical

040-070-21	100	040-353-16	105	040-443-26	111	040-611-21	122
040-071-12	100	040-354-15	103	040-444-21	111	040-611-23	122
040-071-14	100	040-356-15	103	040-444-26	111	040-613-21	122
040-071-18	100	040-358-15	97	040-445-21	111	040-613-23	122
040-071-21	100	040-358-20	97	040-445-26	111	040-614-21	121
040-150-14	101	040-364-14	97	040-448-22	107	040-615-21	121
040-151-14	101	040-366-19	97	040-449-22	107	040-617-21	121
040-152-16	101	040-368-14	99	040-450-24	107	040-621-19	121
040-153-16	101	040-368-16	99	040-451-24	107	040-623-21	121
040-160-14	102	040-369-13	98	040-453-24	104	040-625-23	120
040-161-14	102	040-370-13	96	040-455-01	113	040-629-21	120
040-170-14	102	040-372-13	96	040-455-02	113	040-630-21	119
040-171-14	102	040-376-16	96	040-456-22	115	040-631-21	119
040-180-16	103	040-380-15	102	040-456-23	115	040-650-16	98
040-181-16	103	040-381-15	102	040-456-24	115	040-650-20	98
040-182-16	103	040-382-15	102	040-457-28	114	040-651-16	98
040-183-16	103	040-383-15	102	040-459-18	113	040-651-20	98
040-260-14	106	040-384-20	106	040-459-28	113	040-656-15	98
040-260-16	106	040-384-26	106	040-461-15	113	040-658-25	97
040-260-18	106	040-385-20	106	040-461-19	113	040-658-27	97
040-260-20	106	040-385-26	106	040-463-19	111	040-701-14	118
040-260-22	106	040-386-20	106	040-463-22	111	040-703-18	118
040-260-24	106	040-386-26	106	040-463-24	111	040-709-20	118
040-260-26	106	040-387-20	106	040-465-19	111	040-721-20	119
040-260-30	106	040-387-26	106	040-465-22	111	040-723-20	119
040-261-14	106	040-390-20	107	040-465-24	111	050-010-12	124
040-261-16	106	040-391-20	107	040-467-19	111	050-020-12	124
040-261-18	106	040-393-20	107	040-467-22	111	050-022-12	124
040-261-20	106	040-409-14	108	040-467-24	111	050-028-13	124
040-261-22	106	040-411-14	108	040-471-21	108	050-030-13	124
040-261-24	106	040-411-18	108	040-473-22	113	050-040-13	124
040-261-26	106	040-421-01	110	040-473-23	113	050-046-13	124
040-261-30	106	040-421-02	110	040-475-01	99	050-048-14	124
040-262-13	105	040-421-03	110	040-475-02	99	050-060-15	125
040-262-14	105	040-421-04	110	040-475-18	108	050-070-15	125
040-262-16	105	040-421-05	110	040-477-15	113	050-072-17	125
040-263-13	105	040-421-06	110	040-477-19	113	050-080-14	126
040-263-14	105	040-421-07	110	040-479-22	114	050-080-16	126
040-263-16	105	040-422-01	110	040-479-25	114	050-080-18	126
040-290-13	99	040-422-02	110	040-479-28	114	050-080-20	126
040-290-15	99	040-422-03	110	040-480-15	105	050-080-24	126
040-290-18	99	040-422-04	110	040-480-18	105	050-080-26	126
040-290-20	99	040-422-05	110	040-481-15	105	050-080-30	126
040-291-13	99	040-422-06	110	040-481-18	105	050-090-16	126
040-291-15	99	040-422-07	110	040-497-20	108	050-090-18	126
040-291-18	99	040-423-01	109	040-501-19	114	050-090-20	126
040-291-20	99	040-423-02	109	040-501-23	114	050-096-13	125
040-340-16	105	040-423-03	109	040-503-18	114	050-110-15	126
040-340-20	105	040-423-04	109	040-505-24	115	050-141-21	127
040-341-16	105	040-424-14	102	040-507-22	115	050-148-23	127
040-341-20	105	040-429-18	112	040-509-20	116	050-150-27	127
040-347-14	102	040-429-22	112	040-509-22	116	050-160-27	127
040-350-14	106	040-429-25	112	040-509-24	116	050-190-18	125
040-350-16	106	040-429-28	112	040-511-23	116	050-192-18	125
040-350-18	106	040-431-14	112	040-513-23	116	050-193-27	127
040-350-20	106	040-431-16	112	040-517-23	117	050-211-27	127
040-350-22	106	040-431-18	112	040-523-22	115	050-230-23	128
040-350-24	106	040-431-20	112	040-523-23	115	050-306-14	128
040-350-26	106	040-431-23	112	040-525-22	115	050-310-14	128
040-350-30	106	040-431-25	112	040-525-23	115	050-310-17	128
040-351-14	106	040-431-28	112	040-529-21	114	050-310-18	128
040-351-16	106	040-433-20	112	040-533-01	107	050-350-14	129
040-351-18	106	040-433-24	112	040-533-02	107	050-350-17	129
040-351-20	106	040-433-28	112	040-540-19	103	050-350-20	129
040-351-22	106	040-436-21	114	040-541-19	103	050-354-14	129
040-351-24	106	040-438-21	114	040-543-19	112	050-354-17	129
040-351-26	106	040-441-01	109	040-543-21	112	050-356-17	129
040-351-30	106	040-441-02	109	040-543-24	112	050-356-20	129
040-352-13	105	040-441-03	109	040-601-24	119	050-358-14	130
040-352-14	105	040-441-04	109	040-602-25	119	050-358-17	130
040-352-16	105	040-442-21	111	040-606-20	120	050-358-20	130
040-353-13	105	040-442-26	111	040-606-25	120	050-362-18	128
040-353-14	105	040-443-21	111	040-607-21	121	050-550-10	130

050-551-10	130	051-224-18	134	056-333-21	147	062-058-01	158
050-570-14	131	051-224-20	134	056-333-27	147	062-058-02	158
050-570-18	131	051-224-26	134	056-450-20	147	062-058-03	158
050-571-14	131	051-230-22	140	056-451-19	147	062-060-13	158
050-571-18	131	051-230-23	140	056-451-20	147	062-070-01	159
050-576-14	131	051-240-15	139	056-452-01	148	062-070-02	159
050-576-18	131	051-242-20	139	056-452-02	148	062-070-03	159
050-577-14	131	051-250-16	133	056-452-03	148	062-070-04	159
050-577-18	131	051-250-18	133	056-454-01	148	062-074-16	158
050-600-18	131	051-250-20	133	056-454-02	148	062-078-01	158
050-601-14	130	051-250-23	133	056-455-25	148	062-078-02	158
050-601-18	131	051-250-26	133	056-458-21	148	062-080-01	159
050-621-13	130	051-310-14	140	056-460-01	149	062-080-02	159
050-630-18	131	051-310-17	140	056-460-02	149	062-082-01	160
050-631-18	131	051-310-18	140	056-460-03	149	062-082-02	160
050-650-14	132	051-330-16	140	056-467-01	149	062-088-02	160
050-651-14	132	051-350-14	141	056-467-02	149	062-088-03	160
050-653-14	132	051-350-17	141	056-468-15	149	062-088-04	160
050-661-14	132	051-350-20	141	056-469-14	149	062-089-02	160
050-663-14	132	051-356-17	142	056-470-01	149	062-089-03	160
050-671-13	132	051-356-20	142	056-470-02	150	062-089-04	160
050-673-13	132	051-356-23	142	056-472-23	150	062-101-01	160
051-010-12	133	051-358-14	141	056-473-23	150	062-101-02	160
051-028-13	133	051-358-17	141	056-474-01	150	062-101-03	160
051-029-13	133	051-358-20	141	056-474-02	150	062-101-04	160
051-030-13	134	051-360-18	143	056-477-24	150	062-102-01	160
051-040-13	134	051-360-20	143	056-480-01	150	062-102-02	160
051-048-12	133	051-360-23	143	056-480-02	150	062-102-03	160
051-048-14	133	051-362-18	140	056-481-23	150	062-102-04	160
051-060-15	134	051-364-20	143	056-500-01	151	062-103-01	160
051-060-18	134	051-364-23	143	056-500-02	151	062-103-02	160
051-080-16	135	051-366-17	142	056-500-03	151	062-103-03	160
051-080-18	135	051-366-20	142	056-500-04	151	062-103-04	160
051-080-20	135	051-390-18	144	056-502-22	152	062-111-01	161
051-080-24	135	051-428-14	133	056-503-22	152	062-111-02	161
051-080-26	135	051-560-14	144	056-506-19	152	062-111-03	161
051-080-30	135	051-561-14	144	056-507-19	152	062-111-04	161
051-084-20	139	051-562-14	144	056-508-03	152	062-112-01	161
051-084-24	139	051-563-14	144	056-508-05	152	062-112-02	161
051-090-14	138	051-570-14	144	056-508-07	152	062-112-03	161
051-090-18	138	051-570-18	144	056-510-25	153	062-112-04	161
051-090-20	138	051-571-14	144	056-510-28	153	062-140-01	161
051-090-23	138	051-571-18	144	056-513-15	153	062-140-02	161
051-114-18	136	051-576-14	144	056-513-16	153	062-150-01	162
051-114-20	136	051-576-18	144	056-514-15	153	062-150-02	162
051-114-23	136	051-577-14	144	056-514-16	153	062-150-03	162
051-114-26	136	051-577-18	144	056-516-18	153	062-150-04	162
051-114-31	136	056-211-01	145	056-521-18	153	062-150-05	162
051-114-37	136	056-211-02	145	056-521-27	153	062-150-06	162
051-132-13	136	056-211-03	145	056-530-23	154	062-160-10	162
051-132-15	136	056-211-04	145	056-531-21	154	062-160-20	162
051-132-18	136	056-221-01	145	056-532-23	154	062-162-01	161
051-132-20	136	056-221-02	145	056-550-12	154	062-162-02	161
051-132-23	136	056-221-03	145	056-552-13	154	062-164-01	162
051-132-26	136	056-221-04	145	056-553-14	154	062-164-02	162
051-134-13	137	056-223-01	145	056-555-01	154	062-164-03	162
051-134-15	137	056-223-02	145	056-556-12	154	062-164-04	162
051-134-18	137	056-223-03	145	056-558-00	155	062-166-16	162
051-134-20	137	056-223-04	145	056-558-12	155	062-170-14	163
051-134-23	137	056-320-20	146	056-559-10	155	062-174-15	163
051-134-26	137	056-321-20	146	056-560-01	155	062-178-15	163
051-136-15	137	056-322-20	146	056-560-02	155	062-179-15	163
051-136-17	137	056-323-20	146	056-570-08	155	062-180-16	163
051-136-20	137	056-324-21	147	056-570-11	155	062-181-16	163
051-141-20	135	056-324-27	147	056-570-12	155	062-200-08	164
051-141-24	135	056-325-21	147	056-570-14	155	062-200-10	164
051-141-26	135	056-325-27	147	056-570-16	155	062-200-12	164
051-150-27	138	056-328-20	146	056-570-18	155	062-200-14	164
051-160-27	138	056-329-20	146	056-570-20	155	062-200-16	164
051-185-20	139	056-330-20	146	056-570-22	155	062-200-18	164
051-185-24	139	056-331-20	146	062-050-01	158	062-204-08	164
051-185-26	139	056-332-21	147	062-050-02	158	062-204-10	164
051-211-27	138	056-332-27	147	062-054-15	158	062-204-12	164

Index numerisch
Index numerical

062-204-14	164	064-012-06	172	064-272-90	181	070-611-05	188
062-204-16	164	064-012-08	172	064-274-01	181	070-611-07	188
062-204-18	164	064-013-01	172	064-274-02	181	070-620-07	188
062-210-08	165	064-013-02	172	064-274-03	181	070-620-10	188
062-210-10	165	064-013-03	172	064-280-61	180	070-621-07	188
062-210-12	165	064-013-04	172	064-280-62	180	070-621-10	188
062-210-14	165	064-013-06	172	064-280-91	180	070-622-07	188
062-210-16	165	064-013-08	172	064-280-92	180	070-622-10	188
062-210-18	165	064-021-24	173	064-290-38	181	070-630-10	188
062-212-08	165	064-022-24	173	064-290-51	181	070-631-10	188
062-212-10	165	064-032-04	173	064-320-25	182	070-650-10	191
062-212-12	165	064-032-05	173	064-320-26	182	070-651-10	191
062-212-14	165	064-032-06	173	064-320-27	182	070-660-14	189
062-212-16	165	064-032-07	173	064-350-16	183	070-661-14	189
062-212-18	165	064-100-55	173	064-350-25	183	070-670-13	191
062-220-08	166	064-100-60	173	064-350-50	183	070-670-16	191
062-220-11	166	064-100-63	173	064-360-08	183	070-670-20	191
062-220-13	166	064-110-30	174	064-360-10	183	070-671-13	191
062-220-17	166	064-110-31	174	064-360-12	183	070-671-16	191
062-220-20	166	064-110-32	174	064-360-14	183	070-671-20	191
062-220-23	166	064-110-40	174	064-360-16	183	070-672-11	192
062-230-08	166	064-110-50	174	064-360-18	183	070-673-11	192
062-230-11	166	064-120-30	174	064-370-08	184	070-674-15	190
062-230-13	166	064-120-31	174	064-370-10	184	070-684-16	189
062-230-17	166	064-120-32	174	064-370-12	184	070-685-16	189
062-230-20	166	064-120-40	174	064-370-14	184	070-690-31	194
062-230-23	166	064-120-50	174	064-370-16	184	070-691-32	195
062-250-20	166	064-130-22	175	064-370-18	184	070-810-10	190
062-300-12	167	064-130-25	175	064-390-01	182	070-810-13	190
062-302-15	167	064-130-26	175	064-390-02	182	070-810-15	190
062-310-00	167	064-130-35	175	064-390-03	182	070-810-18	190
062-310-01	167	064-130-36	175	064-500-40	182	070-811-10	190
062-310-02	167	064-130-37	175	064-500-62	182	070-811-13	190
062-310-03	167	064-130-40	175	064-600-25	186	070-811-15	190
062-310-04	167	064-130-70	175	064-600-38	186	070-811-18	190
062-340-06	168	064-130-80	175	064-600-50	186	070-822-17	190
062-342-13	168	064-130-85	175	064-600-75	186	070-830-13	192
062-350-00	168	064-140-18	176	064-602-18	184	070-831-13	192
062-360-00	168	064-140-20	176	064-602-22	184	070-840-13	192
062-370-16	169	064-140-25	176	064-602-23	184	070-850-13	193
062-370-20	169	064-140-30	176	064-604-30	185	070-860-20	193
062-370-25	169	064-140-40	176	064-604-33	185	070-860-26	193
062-380-00	168	064-150-44	176	064-604-36	185	070-861-20	193
062-390-00	169	064-150-55	176	064-610-38	185	070-861-26	193
062-396-19	169	064-150-72	176	064-610-50	185	070-870-01	194
064-001-01	170	064-164-20	180	064-610-75	185	070-870-02	194
064-001-02	170	064-180-01	177	064-700-30	186	070-870-03	194
064-001-03	170	064-180-02	177	064-700-32	186	070-870-04	194
064-001-04	170	064-180-03	177	064-710-50	186	070-871-01	194
064-001-06	170	064-182-01	177	064-710-90	186	070-871-02	194
064-001-08	170	064-182-02	177	064-720-01	186	070-871-03	194
064-002-01	171	064-182-03	177	064-720-02	186	070-871-04	194
064-002-02	171	064-192-01	178	064-721-01	186	074-310-01	200
064-002-03	171	064-192-02	178	064-721-02	186	074-310-02	200
064-002-04	171	064-192-03	178	070-202-14	193	074-310-03	200
064-002-06	171	064-200-00	178	070-202-19	193	074-310-28	198
064-002-08	171	064-200-01	178	070-240-10	195	074-312-30	198
064-003-01	170	064-200-02	178	070-240-14	195	074-330-24	199
064-003-02	170	064-220-01	179	070-250-19	193	074-331-01	200
064-003-03	170	064-220-02	179	070-300-16	197	074-331-02	200
064-003-04	170	064-220-03	179	070-300-19	197	074-331-03	200
064-003-06	170	064-230-50	178	070-300-25	197	074-332-24	199
064-003-08	170	064-240-40	178	070-300-32	197	074-334-24	199
064-011-01	171	064-240-50	178	070-301-16	197	074-360-01	200
064-011-02	171	064-240-60	178	070-320-17	198	074-360-02	200
064-011-03	171	064-240-75	178	070-330-18	198	074-360-03	200
064-011-04	171	064-240-85	178	070-330-23	198	074-360-27	199
064-011-06	171	064-250-70	179	070-401-22	196	074-398-01	200
064-011-08	171	064-250-81	179	070-411-17	196	074-398-02	200
064-012-01	172	064-250-82	179	070-420-17	196	074-398-03	200
064-012-02	172	064-250-83	179	070-430-15	196	074-398-10	200
064-012-03	172	064-260-01	180	070-610-05	188	074-398-11	200
064-012-04	172	064-260-02	180	070-610-07	188	074-398-12	200

074-398-13	200	074-910-12	209	080-150-00	217	084-184-55	221
074-399-01	200	074-910-13	209	080-150-01	217	084-190-14	220
074-399-02	200	074-910-14	209	080-150-03	217	085-000-27	222
074-399-03	200	074-915-30	209	080-150-06	217	085-006-24	222
074-399-10	200	074-920-01	209	080-150-09	217	085-007-26	222
074-399-13	200	074-920-02	209	080-150-12	217	085-008-27	222
074-399-14	200	074-920-10	209	080-150-20	217	085-010-17	222
074-399-23	200	074-920-11	209	080-150-21	217	085-010-35	222
074-399-33	200	074-920-12	209	080-150-22	217	085-012-15	223
074-400-10	201	074-920-13	209	080-260-16	216	085-012-25	223
074-412-14	201	074-920-16	209	080-262-18	216	085-012-35	223
074-414-16	201	074-920-20	209	080-264-28	216	085-014-23	222
074-610-00	203	078-170-13	210	080-270-12	216	085-016-22	223
074-760-09	203	078-170-25	210	080-270-14	216	085-020-06	221
074-764-18	202	078-170-32	210	080-270-16	216	085-020-10	221
074-768-20	202	078-170-40	210	080-270-18	216	085-021-06	221
074-768-25	202	078-170-50	210	080-271-12	216	085-021-08	221
074-772-01	202	078-200-01	210	080-271-14	216	085-024-00	222
074-772-02	202	078-200-02	210	080-271-16	216	085-024-01	222
074-772-25	202	078-200-03	210	080-271-18	216	085-024-02	222
074-798-01	203	078-210-06	210	084-100-03	218	085-024-03	222
074-798-02	203	078-210-12	210	084-100-04	218	085-024-04	222
074-798-03	203	078-210-17	210	084-102-03	219	085-030-06	223
074-799-70	203	078-210-20	210	084-102-04	219	085-030-08	223
074-850-18	203	078-210-25	210	084-110-30	218	085-030-10	223
074-850-23	203	078-220-20	210	084-110-35	218	085-030-12	223
074-850-30	203	078-230-28	210	084-110-40	218	085-033-06	223
074-850-45	203	080-000-11	214	084-110-45	218	085-033-08	223
074-859-01	204	080-000-13	214	084-110-50	218	085-033-10	223
074-859-02	204	080-000-14	214	084-110-55	218	085-033-12	223
074-859-03	204	080-000-16	214	084-110-60	218	085-034-06	223
074-859-04	204	080-000-18	214	084-112-30	218	085-034-08	223
074-859-05	204	080-000-20	214	084-112-35	218	085-034-10	223
074-859-06	204	080-004-11	214	084-112-40	218	085-034-12	223
074-859-07	204	080-004-13	214	084-112-45	218	085-050-21	223
074-859-08	204	080-004-14	214	084-112-50	218	085-060-01	223
074-859-09	204	080-004-16	214	084-112-55	218	085-060-02	223
074-860-00	205	080-004-18	214	084-112-60	218	085-060-03	223
074-860-01	205	080-004-20	214	084-114-30	218	085-060-04	223
074-860-11	205	080-013-11	214	084-114-35	218	086-000-01	224
074-860-22	205	080-013-13	214	084-114-40	218	086-000-02	224
074-870-00	205	080-013-14	214	084-114-45	218	086-000-03	224
074-870-01	205	080-013-16	214	084-114-50	218	086-000-04	224
074-870-11	205	080-013-18	214	084-114-55	218	086-000-05	224
074-880-00	206	080-013-20	214	084-114-60	218	086-000-06	224
074-880-01	206	080-027-11	214	084-118-07	218	086-000-07	224
074-880-02	206	080-027-13	214	084-118-09	218	086-060-16	225
074-880-03	206	080-027-14	214	084-118-12	218	086-090-12	226
074-880-11	207	080-027-16	214	084-120-01	220	086-090-14	226
074-880-12	207	080-027-18	214	084-120-02	220	086-090-16	226
074-880-13	206	080-027-20	214	084-120-03	220	086-115-01	226
074-880-14	206	080-033-10	214	084-120-04	220	086-115-02	226
074-880-15	206	080-110-11	215	084-124-24	219	086-115-03	226
074-880-16	206	080-110-13	215	084-128-06	220	086-115-04	226
074-880-17	206	080-110-14	215	084-128-08	220	086-115-05	226
074-880-20	207	080-110-16	215	084-130-20	220	086-115-06	226
074-880-21	207	080-110-18	215	084-130-25	220	086-115-07	226
074-882-00	206	080-110-20	215	084-130-30	220	086-115-08	226
074-882-01	206	080-117-14	214	084-140-01	220	086-117-14	226
074-884-00	207	080-120-16	214	084-140-02	220	086-117-18	226
074-890-01	207	080-122-11	215	084-140-03	220	086-120-01	226
074-890-11	208	080-122-13	215	084-140-04	220	086-120-02	226
074-890-12	208	080-122-14	215	084-160-16	219	086-120-03	226
074-890-13	208	080-122-16	215	084-161-16	219	086-120-04	226
074-890-14	208	080-122-18	215	084-170-00	221	086-120-05	226
074-890-15	208	080-126-20	214	084-172-00	221	086-120-06	226
074-900-00	208	080-130-01	215	084-175-00	221	086-120-07	226
074-900-01	208	080-130-02	215	084-180-30	220	086-130-01	225
074-900-11	208	080-130-03	215	084-180-40	220	086-130-02	225
074-900-12	208	080-130-04	215	084-180-50	220	086-130-03	225
074-900-13	208	080-135-01	256	084-184-30	221	086-130-04	225
074-900-14	208	080-135-02	256	084-184-40	221	086-130-05	225
074-910-11	209	080-135-03	256	084-184-50	221	086-130-06	225

Index numerisch
Index numerical

086-140-03	224	140-100-01	211	160-006-24	244	164-231-23	248
086-140-04	224	140-100-02	211	160-010-15	243	164-231-25	248
086-140-05	224	140-100-03	211	160-012-15	243	164-234-22	247
086-140-06	224	140-100-04	211	160-014-20	243	164-234-25	247
086-150-01	224	140-150-01	211	160-020-15	242	164-234-28	247
086-150-14	224	141-001-22	117	160-020-20	242	164-235-22	247
086-180-10	225	141-002-01	118	160-020-23	242	164-235-25	247
086-180-12	225	141-002-02	118	160-030-12	242	164-235-28	247
086-180-15	225	141-003-01	118	160-030-15	242	164-240-24	248
086-200-06	224	141-003-02	118	160-030-19	242	168-010-19	251
086-210-12	225	141-004-20	117	160-040-15	243	168-020-26	251
086-210-15	225	141-005-20	117	160-040-19	243	168-020-28	251
086-650-16	225	154-001-01	232	160-050-20	243	168-108-15	252
086-650-20	225	154-001-02	232	160-070-16	244	168-110-15	252
087-000-01	227	154-005-20	233	160-124-16	242	168-124-25	254
087-000-02	227	154-006-20	233	160-124-20	242	168-124-29	254
087-000-05	227	154-008-20	232	160-124-25	242	168-124-38	254
087-000-10	227	154-009-20	232	160-124-30	242	168-147-00	253
087-000-20	227	154-021-22	232	160-170-18	245	168-147-03	253
087-000-50	227	154-031-01	233	160-170-20	245	168-147-75	253
087-001-01	227	154-031-03	233	160-172-20	245	168-147-95	253
087-001-02	227	154-039-24	233	160-172-23	245	168-150-21	252
087-001-05	227	154-050-01	236	160-178-16	242	168-160-15	252
087-001-10	227	154-050-02	236	160-178-20	242	168-200-00	253
087-001-20	227	154-050-03	236	160-200-18	245	168-212-01	253
087-001-50	227	154-050-04	236	160-201-18	245	168-212-02	253
087-050-01	227	154-050-05	236	160-210-21	245	168-212-03	253
087-050-02	227	154-050-06	236	160-210-23	245	168-212-04	253
087-050-05	227	154-050-07	236	160-211-21	245	168-220-01	254
087-050-10	227	154-050-08	236	160-211-23	245	168-220-02	254
087-050-20	227	154-050-09	236	160-230-21	247	168-220-03	254
087-050-50	227	154-050-10	236	160-230-23	247	168-220-04	254
087-051-01	227	154-050-11	236	160-230-25	247	168-220-05	254
087-051-02	227	154-050-12	236	160-231-21	247	168-220-06	254
087-051-05	227	154-050-13	236	160-231-23	247	168-250-22	254
087-051-10	227	154-056-13	235	160-231-25	247	168-250-30	254
087-051-20	227	154-056-18	235	160-234-22	246	168-268-01	254
087-051-50	227	154-056-21	235	160-234-25	246	168-268-02	254
087-055-02	227	154-058-18	235	160-234-28	246	168-280-01	253
087-055-05	227	154-058-21	235	160-235-22	246	168-280-02	253
087-055-10	227	154-058-24	235	160-235-25	246	168-280-03	253
087-060-01	227	154-058-27	235	160-235-28	246	168-280-04	253
087-060-02	227	154-070-01	234	160-240-24	248	168-280-05	253
087-061-01	227	154-072-01	234	160-253-23	248	168-300-28	255
087-061-02	227	154-074-01	234	160-259-23	248	168-300-35	255
087-065-01	228	154-074-02	234	160-310-15	249	168-300-42	255
087-066-01	228	154-076-34	234	160-310-21	249	168-301-28	255
087-070-05	228	154-078-32	235	160-310-29	249	168-301-35	255
087-070-10	228	154-080-01	234	160-311-15	249	168-301-42	255
087-070-15	228	154-080-02	234	160-311-21	249	168-311-28	255
087-070-20	228	154-080-03	234	160-311-29	249	168-311-35	255
087-071-05	228	154-080-04	234	160-320-05	249	168-311-42	255
087-071-10	228	154-080-05	234	160-320-07	249	168-312-28	255
087-071-15	228	154-080-06	234	160-320-10	249	168-312-35	255
087-071-20	228	154-080-07	234	160-325-26	249	168-312-42	255
087-080-10	228	154-080-08	234	160-340-08	249	168-400-00	255
087-080-20	228	154-082-35	235	160-360-30	250	168-410-00	255
087-080-30	228	158-001-01	232	160-361-30	250	168-471-19	256
087-080-50	228	158-001-02	232	160-364-33	250	168-473-19	256
087-081-10	228	158-001-03	232	160-365-33	250	170-055-01	117
087-081-20	228	158-001-04	232	161-006-16	244	170-055-02	117
087-081-30	228	158-001-05	232	161-006-20	244	170-071-24	238
087-081-50	228	158-001-06	232	161-170-20	244	170-073-23	238
087-911-00	229	158-519-23	116	164-006-16	244	170-075-23	238
087-912-06	229	158-519-24	116	164-006-20	244	170-077-24	238
087-912-08	229	160-000-12	242	164-210-21	246	170-080-20	238
087-913-00	229	160-000-15	242	164-210-23	246	170-080-28	238
087-920-00	229	160-004-15	242	164-211-21	246	170-150-28	238
087-922-00	229	160-004-19	242	164-211-23	246	170-160-00	237
087-926-00	229	160-004-25	242	164-230-21	248	170-172-00	237
087-930-02	229	160-006-16	244	164-230-23	248	170-176-00	237
087-935-00	229	160-006-18	244	164-230-25	248	170-176-01	237
087-939-00	229	160-006-20	244	164-231-21	248	170-176-02	237

170-176-03	237	180-146-01	259	180-270-01	265	180-350-25	270
170-176-04	237	180-146-02	259	180-270-02	265	180-350-26	270
170-182-00	237	180-146-03	259	180-271-01	265	180-350-98	270
170-230-21	239	180-150-01	260	180-271-02	265	180-350-99	270
170-236-22	239	180-150-02	260	180-272-01	265	180-351-01	270
170-238-21	239	180-150-03	260	180-272-02	265	180-351-02	270
170-240-22	239	180-160-00	260	180-275-17	265	180-351-03	270
170-250-26	239	180-170-00	261	180-290-01	265	180-351-04	270
170-257-23	239	180-172-00	261	180-290-02	265	180-351-05	270
170-345-08	240	180-180-00	261	180-290-03	265	180-351-06	270
170-349-11	240	180-180-03	261	180-290-17	265	180-351-07	270
170-350-08	240	180-180-04	261	180-292-01	266	180-351-08	270
170-350-11	240	180-180-05	261	180-292-02	266	180-351-09	270
170-350-13	240	180-180-06	261	180-292-03	266	180-351-10	270
170-350-16	240	180-180-07	261	180-292-04	266	180-351-11	270
170-350-21	240	180-180-08	261	180-294-01	267	180-351-12	270
170-350-26	240	180-180-40	261	180-294-02	267	180-351-13	270
170-350-32	240	180-180-80	261	180-294-03	267	180-351-14	270
170-360-00	240	180-220-01	262	180-300-01	267	180-351-15	270
170-650-08	240	180-220-02	262	180-300-02	267	180-351-16	270
170-650-10	240	180-220-03	262	180-301-01	267	180-351-17	270
170-650-12	240	180-221-01	262	180-301-02	267	180-354-01	271
170-650-14	240	180-221-02	262	180-305-01	267	180-354-03	271
170-650-16	240	180-221-03	262	180-305-02	267	180-354-05	271
170-650-18	240	180-222-01	262	180-307-20	268	180-354-07	271
170-650-20	240	180-222-02	262	180-307-25	268	180-354-09	271
170-650-22	240	180-222-03	262	180-307-30	268	180-354-11	271
170-650-24	240	180-230-01	262	180-307-35	268	180-354-13	271
170-660-06	240	180-230-03	262	180-307-40	268	180-354-15	271
170-660-07	240	180-231-01	262	180-308-20	268	180-354-17	271
170-660-08	240	180-231-02	262	180-308-25	268	180-354-19	271
170-660-09	240	180-231-03	262	180-308-30	268	180-354-21	271
170-660-10	240	180-232-01	262	180-308-35	268	180-354-23	271
170-660-11	240	180-232-02	262	180-308-40	268	180-354-25	271
170-660-12	240	180-232-03	262	180-309-40	268	180-354-98	271
170-660-13	240	180-234-00	263	180-310-20	268	180-354-99	271
170-660-14	240	180-234-01	263	180-311-10	268	180-360-05	271
170-660-15	240	180-234-02	263	180-311-20	268	180-360-06	271
170-660-16	240	180-234-03	263	180-311-25	268	180-360-07	271
170-660-18	240	180-235-00	263	180-312-15	268	180-360-08	271
170-660-20	240	180-235-01	263	180-312-20	268	180-360-09	271
170-660-24	240	180-235-02	263	180-312-25	268	180-360-10	271
180-090-03	269	180-235-03	263	180-312-30	268	180-360-98	271
180-090-04	269	180-236-00	263	180-312-35	268	180-370-05	272
180-090-05	269	180-236-01	263	180-312-40	268	180-370-06	272
180-092-03	269	180-236-02	263	180-313-19	268	180-370-08	272
180-092-04	269	180-236-03	263	180-315-23	268	180-370-09	272
180-092-05	269	180-237-01	263	180-315-25	268	180-370-10	272
180-096-25	269	180-237-02	263	180-317-30	268	180-370-12	272
180-100-01	260	180-238-01	263	180-350-01	270	180-370-13	272
180-100-02	260	180-238-02	263	180-350-02	270	180-370-14	272
180-100-03	260	180-239-01	263	180-350-03	270	180-370-98	272
180-120-01	260	180-239-02	263	180-350-04	270	180-400-25	273
180-120-02	260	180-260-01	264	180-350-05	270	180-402-26	273
180-120-03	260	180-260-02	264	180-350-06	270	180-404-25	273
180-130-01	258	180-260-03	264	180-350-07	270	180-410-18	272
180-130-02	258	180-261-01	264	180-350-08	270	180-412-19	272
180-130-03	258	180-261-02	264	180-350-09	270	180-414-17	272
180-132-00	258	180-261-03	264	180-350-10	270	180-417-20	273
180-134-00	258	180-261-04	264	180-350-11	270	180-419-28	273
180-140-00	259	180-262-01	264	180-350-12	270	180-421-24	273
180-140-01	259	180-262-02	264	180-350-13	270	180-423-24	274
180-140-02	259	180-262-03	264	180-350-14	270	180-426-24	274
180-140-03	259	180-262-04	264	180-350-15	270	180-429-24	274
180-142-01	258	180-264-01	264	180-350-16	270	180-431-23	274
180-142-02	258	180-264-02	264	180-350-17	270	180-434-21	274
180-142-03	258	180-264-03	264	180-350-18	270	180-435-21	274
180-142-04	258	180-265-01	264	180-350-19	270	180-440-06	275
180-142-05	258	180-265-02	264	180-350-20	270	180-440-08	275
180-142-06	258	180-265-03	264	180-350-21	270	180-440-10	275
180-144-01	259	180-266-01	264	180-350-22	270	180-441-06	275
180-144-02	259	180-266-02	264	180-350-23	270	180-441-08	275
180-144-03	259	180-266-03	264	180-350-24	270	180-441-10	275

Index numerisch
Index numerical

180-442-15	275	180-700-20	280	180-712-05	283	181-600-34	292
180-444-20	275	180-700-21	280	180-712-06	283	186-000-14	295
180-446-28	275	180-700-23	280	180-712-07	283	186-002-14	295
180-449-26	275	180-701-05	280	180-712-08	283	186-010-10	295
180-470-20	276	180-701-06	280	180-712-09	283	186-012-14	295
180-472-27	276	180-701-07	280	180-712-11	283	186-020-10	295
180-475-32	276	180-701-08	280	180-712-12	283	186-100-03	295
180-480-25	276	180-701-09	280	180-712-14	283	186-100-04	295
180-482-27	276	180-701-11	280	180-712-15	283	186-100-05	295
180-485-23	276	180-701-12	280	180-712-16	283	186-100-06	295
180-488-25	277	180-701-14	280	180-712-19	283	186-110-03	294
180-500-26	277	180-701-15	280	180-712-20	283	186-110-04	294
180-502-28	277	180-701-16	280	180-712-21	283	186-110-05	294
180-510-32	277	180-701-19	280	180-712-23	283	186-200-02	294
180-511-32	277	180-701-20	280	180-713-05	283	186-200-03	294
180-516-32	277	180-701-21	280	180-713-06	283	186-200-04	294
180-518-32	277	180-701-23	280	180-713-07	283	186-200-05	294
180-521-25	277	180-702-05	281	180-713-08	283	186-200-06	294
180-527-29	277	180-702-06	281	180-713-09	283	186-200-07	294
180-529-28	277	180-702-07	281	180-713-11	283	186-200-08	294
180-530-00	269	180-702-08	281	180-713-12	283	186-210-00	294
180-530-01	269	180-702-09	281	180-713-14	283	186-400-00	294
180-530-02	269	180-702-11	281	180-713-15	283	186-400-01	294
180-540-30	278	180-702-12	281	180-713-16	283	186-400-02	294
180-542-30	278	180-702-14	281	180-713-19	283	186-400-03	294
180-543-30	278	180-702-15	281	180-713-20	283	186-420-01	296
180-550-04	278	180-702-16	281	180-713-21	283	186-420-17	296
180-552-04	278	180-702-19	281	180-713-23	283	186-430-01	296
180-560-04	278	180-702-20	281	180-720-30	284	186-430-16	296
180-560-06	278	180-702-21	281	180-720-35	284	186-500-13	296
180-560-09	278	180-702-23	281	180-720-40	284	186-510-13	296
180-570-25	279	180-703-05	281	180-721-30	284	186-600-13	296
180-572-25	279	180-703-06	281	180-721-35	284	186-610-01	296
180-574-22	279	180-703-07	281	180-721-40	284	186-610-02	296
180-576-01	279	180-703-08	281	180-722-30	285	191-132-20	306
180-576-02	279	180-703-09	281	180-722-35	285	191-145-18	306
180-576-03	279	180-703-11	281	180-722-40	285	191-201-24	306
180-576-04	279	180-703-12	281	180-723-30	285	192-406-00	300
180-576-05	279	180-703-14	281	180-723-35	285	192-406-01	300
180-580-27	279	180-703-15	281	180-723-40	285	192-406-02	300
180-588-01	279	180-703-16	281	180-760-01	286	192-408-00	300
180-588-02	279	180-703-19	281	180-760-02	286	192-408-01	300
180-602-25	287	180-703-20	281	180-760-03	286	192-408-12	300
180-604-20	287	180-703-21	281	180-760-04	286	192-410-16	300
180-608-28	287	180-703-23	281	180-760-05	286	192-411-15	300
180-610-04	287	180-710-05	282	180-760-06	286	192-414-13	300
180-610-06	287	180-710-06	282	181-034-30	289	192-414-14	300
180-614-23	287	180-710-07	282	181-036-33	289	192-414-17	300
180-615-23	287	180-710-08	282	181-036-36	289	192-430-11	300
180-630-10	288	180-710-09	282	181-044-36	290	192-430-12	300
180-630-12	288	180-710-11	282	181-046-36	289	192-448-00	299
180-630-14	288	180-710-12	282	181-052-41	290	192-448-01	299
180-630-40	288	180-710-14	282	181-054-40	290	192-448-02	299
180-630-41	288	180-710-15	282	181-056-28	289	192-448-03	299
180-630-50	288	180-710-16	282	181-058-30	289	192-448-04	299
180-680-24	286	180-710-19	282	181-058-36	289	192-452-01	299
180-682-21	286	180-710-20	282	181-058-38	289	192-452-02	299
180-682-29	286	180-710-21	282	181-060-44	290	192-452-11	299
180-684-24	286	180-710-23	282	181-080-32	290	192-467-01	298
180-686-24	287	180-711-05	282	181-080-38	290	192-467-02	298
180-688-21	287	180-711-06	282	181-084-36	290	192-467-03	298
180-690-26	287	180-711-07	282	181-084-40	290	192-467-11	298
180-700-05	280	180-711-08	282	181-200-21	291	192-467-12	298
180-700-06	280	180-711-09	282	181-244-01	291	192-467-13	298
180-700-07	280	180-711-11	282	181-244-02	291	192-467-14	298
180-700-08	280	180-711-12	282	181-244-03	291	192-469-01	298
180-700-09	280	180-711-14	282	181-245-01	291	192-469-02	298
180-700-11	280	180-711-15	282	181-245-02	291	192-469-03	298
180-700-12	280	180-711-16	282	181-245-03	291	192-469-04	298
180-700-14	280	180-711-19	282	181-252-30	291	192-469-11	298
180-700-15	280	180-711-20	282	181-260-27	291	192-469-12	298
180-700-16	280	180-711-21	282	181-261-27	291	192-469-13	298
180-700-19	280	180-711-23	282	181-300-42	292	192-469-14	298

Index numerisch

192-469-15	298	194-336-04	304	250-140-27	309
192-469-16	298	194-336-05	304	250-142-06	309
192-472-01	298	194-336-06	304	250-142-07	309
192-472-02	298	194-350-06	305	250-142-08	309
192-472-03	298	194-350-09	305	250-142-09	309
192-472-04	298	194-350-13	305	250-151-14	308
192-472-11	298	194-350-16	305	250-154-12	308
192-472-12	298	194-350-19	305	250-160-20	308
192-472-13	298	194-350-25	305	250-163-27	308
192-472-14	298	194-350-32	305	250-164-23	308
192-472-15	298	194-351-06	305	250-166-35	308
192-472-16	298	194-351-09	305	250-200-01	310
192-487-01	299	194-351-13	305	250-200-02	310
192-487-02	299	194-351-16	305	250-200-03	310
192-487-11	299	194-351-19	305	250-200-04	310
192-487-12	299	194-351-25	305	250-200-05	310
193-440-19	301	194-351-32	305	250-200-06	310
193-465-01	302	194-352-09	306	250-200-07	310
193-465-02	302	194-352-14	306	250-200-08	310
193-465-03	302	194-352-16	306	250-200-09	310
193-465-04	302	194-352-19	306	250-300-00	310
193-472-19	303	194-352-25	306	250-300-01	310
193-476-15	302	194-353-09	306	250-310-50	310
193-477-10	302	194-353-14	306	250-800-01	311
193-477-15	302	194-353-16	306	250-800-02	311
193-477-20	302	194-353-19	306	250-800-10	311
193-477-25	302	194-353-25	306		
193-478-15	302	194-360-10	305		
193-479-15	303	194-360-12	305		
193-480-04	303	194-360-15	305		
193-480-06	303	194-360-25	305		
193-480-08	303	194-361-10	304		
193-481-17	303	194-361-15	304		
193-485-17	303	194-361-20	304		
193-487-17	303	194-361-25	304		
193-488-21	303	194-362-10	305		
193-501-17	301	194-362-12	305		
193-512-16	301	194-362-15	305		
193-512-17	301	194-362-25	305		
193-520-08	301	194-450-06	306		
193-520-10	301	194-450-15	306		
194-300-08	304	194-450-20	306		
194-300-10	304	194-450-25	306		
194-300-12	340	194-450-30	306		
194-300-14	304	194-450-38	306		
194-300-16	304	194-450-44	306		
194-301-08	304	194-450-50	306		
194-301-10	304	194-451-06	306		
194-301-12	304	194-451-15	306		
194-301-14	304	194-451-20	306		
194-301-16	304	194-451-25	306		
194-302-08	304	194-451-30	306		
194-302-10	304	194-451-38	306		
194-302-12	304	194-451-44	306		
194-302-14	304	194-451-50	306		
194-302-16	304	250-130-04	309		
194-318-04	305	250-130-06	309		
194-318-06	305	250-130-08	309		
194-318-08	305	250-130-10	309		
194-318-10	305	250-130-12	309		
194-318-12	305	250-130-15	309		
194-318-14	305	250-133-00	309		
194-319-04	305	250-133-10	309		
194-319-06	305	250-133-20	309		
194-319-08	305	250-133-30	309		
194-319-10	305	250-133-40	309		
194-319-12	305	250-133-50	309		
194-319-14	305	250-133-60	309		
194-334-03	304	250-133-70	309		
194-334-04	304	250-133-80	309		
194-334-05	304	250-133-90	309		
194-334-06	304	250-140-17	309		
194-336-03	304	250-140-25	309		

Email :

rishsurgicalinstruments@gmail.com

Phone : +92 3365240977 (WhatsApp)

FDA c GMP CE

